

Copeland™ compressor – Parts and accessories

Copeland™ compressor Parts and accessories



Table of Contents

A - Hermetic Compressors.....	3
AF Compressors Parts.....	4
AR Compressors Parts	5
AS Compressors Parts.....	7
C - Hermetic Compressors.....	8
CF Compressors Parts.....	10
CR Compressors Parts	10
CS Compressors Parts	13
CT Compressors Parts.....	13
R - Hermetic Compressors	14
RE Compressors Parts	16
RF Compressors Parts.....	16
RR Compressors Parts	17
RS Compressors Parts	18
E - Semi-Hermetic Compressors.....	21
EA Compressors Parts.....	22
ER Compressors Parts	24
H - Semi-Hermetic Compressors	25
HA Compressors Parts.....	26
K - Semi-Hermetic Compressors	27
KA Compressors Parts.....	28
L - Semi-Hermetic Compressors.....	32
LA Compressors Parts	33
M - Semi-Hermetic Compressors	34
MR Compressors Parts.....	35
N - Semi-Hermetic Compressors	36
NR Compressors Parts	37
2D - Semi-Hermetic Compressors	38
2D Compressors Parts.....	41
3A/R - Semi-Hermetic Compressors.....	43
3A Compressors Parts	44
3R Compressors Parts.....	44
3D - Semi-Hermetic Compressors	45
3D Floating Reed Models.....	49
3D Delta Reed Models	53
3D Digital Models.....	57
3D Capacity Control Kits	58
4D/R - Semi-Hermetic Compressors.....	59
4D Floating Reed Models.....	63
4D Delta Reed Models.....	68
4D Capacity Control Kits	73
4R Compressors Parts.....	74
4R Capacity Control Kits	75
4D - Discus III Semi-Hermetic Compressors.....	76
4D Discus III to Discus II Matrix	77
4D Discus III Delta Reed Model.....	80
4D Discus III Capacity Control Kits.....	82

4M - CO₂ Semi-Hermetic Compressors.....	83
4M CO ₂ Compressor Parts.....	84
6D/R/T - Semi-Hermetic Compressors.....	85
6D Floating Reed Models.....	89
6D Delta Reed Models	95
6D Capacity Control Kits	98
6R Compressor Parts.....	101
6R Capacity Control Kits	103
6T Compressor Parts	103
6D Discus III Semi-Hermetic	104
6D Discus III to Discus II Matrix	106
6D Discus III Delta Reed Models	107
6D Discus III Capacity Control Kits	110
9R - Semi-Hermetic Compressors	111
9R - Compressor Parts	113
ZB - Scroll Compressors	115
ZB Compressor Parts.....	117
ZF - Scroll Compressors.....	119
ZF Compressor Parts.....	122
ZO - Scroll Compressors	123
ZO Compressor Parts	125
ZP - Scroll Compressors.....	126
ZP Compressor Parts.....	128
ZPS Compressor Parts	132
ZPT Compressor Parts	132
ZPU Compressor Parts	133
ZR - Scroll Compressors	134
ZR Compressor Parts	136
ZRS Compressor Parts	140
ZRU Compressor Parts.....	140
ZRT Compressor Parts	141
ZS - Scroll Compressors.....	142
ZS Compressor Parts.....	144
Quick Reference Guide	145
Semi-Hermetic Mounting Parts/Kits	145
Reed Compressor Service Valves	146
Discus Compressor Service Valves	147
Sweat Connection Sizes	149
Rotalock Valve Kits	154
Adapter Kits.....	155
Semi-Hermetic Oil Charges	156
3D Moduload.....	157
Digital Models.....	161
Emerson Approved Contactors	162
Parts Warranty Information	164

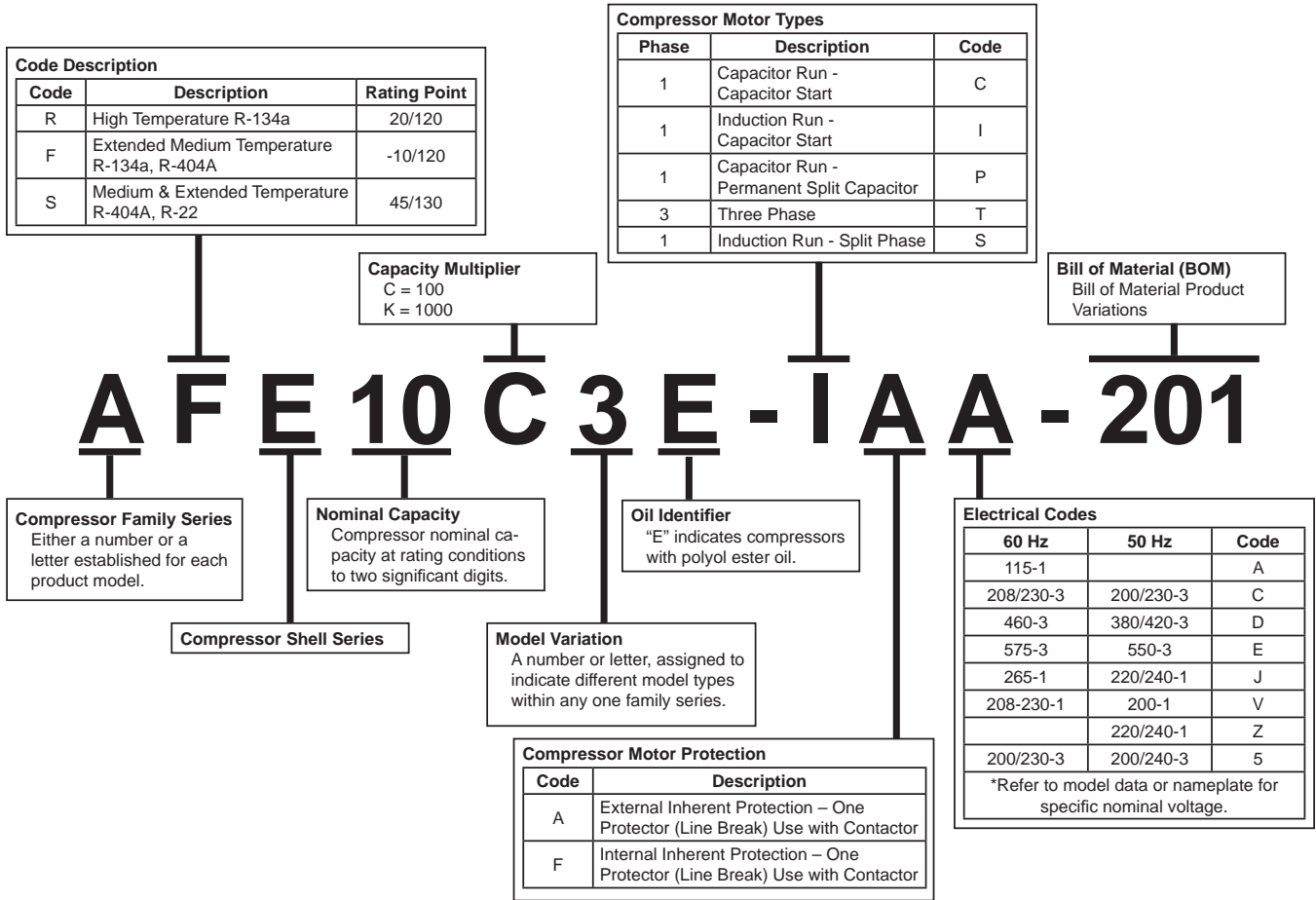

Crankcase Heaters

Models	OEM	Service	Voltage	Watts	Lead Length (in)
	(018-)	(918-)			
A*B / A*E	0048-02	0048-00	120V	35	30
A*B / A*E	0048-03	0048-01	240V	35	30
A*T	0090-00	0049-00	120V	48	30
A*T	0090-01	0049-01	240V	48	30



A – Hermetic Compressors

AF - Compressor Parts

Model	Start Capacitor		Run Capacitor		Current Relay		Potential Relay		Overload		MTG Parts
	OEM	Service	OEM	Service	OEM	Service	OEM	Service	OEM	Service	
	(014-)	(914-)	(014-)	(914-)	(040-)	(940-)	(040-)	(940-)	(071-)	(971-)	
AF07C1(E)-IAA*	0053-18	0053-00			0163-10	C411-82			N/A	C100-35	C001-02
AF22C1(E)-IAA*	0053-18	0053-00			0172-00	C016-00			0605-00	C100-41	C001-00
AFB04C3(E)-SAA*					0162-13	C401-40			0561-13	0554-00	C001-02
AFB05C3(E)-IAA*	0053-35	0038-04			0163-00	C411-58			0561-08	0554-01	C001-02
AFB05C3(E)-SAA*					0163-00	C411-58			0561-08	0554-01	C001-02
AFB06C3(E)-IAA*	0053-26	0053-10			0163-01	C411-66			0561-11	0554-43	C001-02
AFB09C3(E)-IAA*	0053-26	0053-10			0163-14	C411-71			0561-15	0554-44	C001-02
AFE05C4(E)-IAA*	0053-26	0053-10			0163-11	C411-63			0561-28	0554-42	C001-02
AFE06C4(E)-IAA*	0053-18	0053-00			0163-13	C411-72			0561-29	0554-40	C001-02
AFE07C3(E)-IAA*	0053-26	0053-10			0163-10	C411-82			0561-02	0554-15	C001-02
AFE08C4(E)-IAA*	0053-18	0053-00			0163-15	0150-31			0561-23	0554-19	C001-02
AFE10C3(E)-IAA*	0053-26	0053-10			0163-05	C411-89			0561-24	0554-17	C001-02
AFE11C3(E)-IAA*	0053-18	0053-00			0163-10	C411-82			0561-16	0554-22	C001-02
AFE11C4(E)-IAA*	0053-18	0053-00			0163-13	C411-72			0561-21	0554-28	C001-02
AFE12C3(E)-IAA*	0053-35	0038-04			0163-06	C411-83			0561-28	0554-42	C001-02
AFE12C4(E)-IAA*	0053-25	0053-09			0163-06	C411-83			0561-28	0554-42	C001-02
AFE13C3(E)-IAA*	0053-35	0038-04			0163-06	C411-83			0561-03	0554-27	C001-02
AFE13C3(E)-IAV*	0053-37	0038-15			0150-14	C411-47	0166-38	0001-80	0561-04	0554-45	C001-02
AFE13C4(E)-IAA*	0053-35	0053-04			0163-06	C411-83			0561-47	N/A	C001-02
AFE17C4(E)-CAA*	0072-02	0036-15	0064-12	0037-16			0166-21	0001-62	0568-48	0561-48	C001-02
AFE17C4(E)-IAA*	0053-35	0053-04			0163-05	C411-89			0568-48	0561-48	C001-02
AFE17C4(E)-IAV*	0053-27	0053-11			0150-14	C411-47			0561-62	0561-62	C001-02
AFT12C1(E)-IAA*	0053-35	0038-04			0163-08	0163-08			0063-08	C100-69	C001-00
AFT12C1(E)-IAV*	0053-27	0053-11			0163-01	C411-66			0603-01	C603-01	C001-00
AFT12C1-IAA*	0053-35	0038-04			0163-10	0163-06			0603-08	C100-25	C001-00
AFT18C1(E)-IAA*	0053-26	0053-10			0163-07	0163-07			0603-11	0603-11	C001-00
AFT18C1(E)-IAV*	0053-30	0053-14			0163-02	C411-79			0603-03	0603-03	C001-00
AFT22C1(E)-CFV*	0061-27	0036-03	0064-09	0037-13			0166-39	0001-82			C001-00
AFT22C1(E)-IAA*	0053-18	0053-00			0172-00	C016-00			0605-00	C100-41	C001-00
AFT26C1(E)-CFA*	0061-28	0036-04	0064-11	0037-15			0166-37	0001-79			C001-00
AFT26C1(E)-CFV*	0061-27	0036-03	0064-09	0037-13			0166-13	0001-53			C001-00
AFT29C1(E)-CFA*	0061-33	0036-12	0064-11	0037-15			0166-37	0001-79			C001-00
AFT29C1(E)-CFV*	0061-27	0036-03	0064-09	0037-13			0166-13	0001-53			C001-00
AFJ23C1-IAA*	0061-32	0036-09					0166-38	0001-80	0605-03	C100-09	C001-00
AFJ23C2-IAA*	0061-32	0036-09					0166-38	0001-80	0605-03	C100-09	C001-00
AFJ31C1(E)-CFV*	0061-27	0036-03	0064-10	0037-14			0166-29	0001-70			C001-00
AFJ31C2(E)-CFV*	0061-27	0036-03	0064-10	0037-14			0166-29	0001-70			C001-00
AFJ37C1(E)-CFV*	0061-27	0036-03	0064-10	0037-14			0166-29	0001-70			C001-00
AFJ37C2(E)-CFV*	0061-27	0036-03	0064-10	0037-14			0166-29	0001-70			C001-00

AR - Compressor Parts

Model	Start Capacitor		Run Capacitor		Current Relay		Potential Relay		Overload		MTG Parts
	OEM	Service	OEM	Service	OEM	Service	OEM	Service	OEM	Service	
	(014-)	(914-)	(014-)	(914-)	(040-)	(940-)	(040-)	(940-)	(071-)	(971-)	
ARB09C3-SAA*					0162-00	C401-25			0554-35	0554-35	C001-02
ARB10C3-SAA*					0170-08	C401-40			0561-18	0554-04	C001-02
ARB13C3(E)-IAA*	0053-18	0053-00			0167-16	C411-52			0561-25	0554-04	C001-02
ARB13C3(E)-SAA*					0170-08	C401-40			0561-25	0554-05	C001-02
ARB17C3(E)-IAA*	0053-18	0053-00			0167-15	C411-61			0561-09	0561-09	C001-02
ARB17C3(E)-SAA*					0170-11	0152-00			0561-09	0561-09	C001-02
ARB21C3-IAA*	0053-18	0053-00			0163-13	C411-72			0561-01	0561-01	C001-02
ARE13C4E -IAA*	0053-26	0053-10			0163-01	C411-66			0561-28	0554-42	C001-02
ARE17C4E -IAA*	0053-26	0053-10			0163-01	C411-66			0561-28	0554-42	C001-02
ARE25C3(E)-IAA*	0053-18	0053-00			0163-11	C411-63			0561-23	0554-19	C001-02
ARE25C3(E)-SAA*					0162-01	C411-72			0561-23	0554-19	C001-02
ARE25C4(E)-IAA*	0053-18	0053-00			0163-13	C411-72			0561-28	0554-42	C001-02
ARE27C3(E)-IAA*	0053-18	0053-00			0167-02	C411-66			0561-23	0554-19	C001-02
ARE27C3(E)-SAA*					0170-07	C401-66			0561-23	0554-19	C001-02
ARE29C4(E)-IAA*	0053-18	0053-00			0163-13	C411-72			0561-21	0554-28	C001-02
ARE34C4(E)-IAA*	0053-35	0053-04			0163-06	C411-83			0561-50	0561-50	C001-02
ARE35C3-IAA*	0053-18	0053-00			0163-14	C411-71			0561-03	0554-27	C001-02
ARE35C3-IAV*	0053-37	0053-15			0150-25	C411-55			0561-01	0561-01	C001-02
ARE36C3-IAA*	0053-19	0038-01			0163-10	C411-82			0561-16	0554-22	C001-02
ARE36C3-SAA*					0170-03	C401-82			0561-16	0554-22	C001-02
ARE37C3(E)-IAA*	0053-35	0038-04			0163-10	C411-82			0561-16	0554-22	C001-02
ARE37C3(E)-IAV*	0053-30	0053-14			0150-04	C411-45			0561-00	0561-00	C001-02
ARE37C3(E)-SAA*					0170-03	C401-82			0561-16	0554-22	C001-02
ARE40C4(E)-IAA*	0053-25	0053-09			0163-06	0150-33			0561-03	0554-27	C001-02
ARE41C3(E)-IAA*	0053-35	0038-04			0163-06	C411-83			0561-32	0554-25	C001-02
ARE41C3(E)-IAV*	0053-27	0038-13			0140-18	C411-73			0561-00	0561-00	C001-02
ARE41C3-SAA*					0162-01	C401-72			0561-17	0561-17	C001-02
ARE43C3-IAA*	0053-18	0053-00			0163-10	C411-82			0561-17	0561-17	C001-02
ARE46C4(E)-IAA*	0053-25	0053-09			0163-05	C411-89			0561-51	0561-51	C001-02
ARE47C3-IAA*	0053-26	0053-10			0163-10	C411-82			0561-17	0561-17	C001-02
ARE47C3-IAV*	0053-27	0038-13			0167-13	C411-78			0561-00	0554-48	C001-02
ARE51C4(E)-CAA*	0061-34	0058-43					0166-21	0001-62	0561-73	0561-73	C001-02
ARE51C4(E)-IAV*	0053-29	0053-13			0163-04	C411-80			0561-28	0554-42	C001-02
ARE59C3-CAA*	0072-00	0036-11	0064-10	0037-14			0166-45	0001-88	0561-07	0554-30	C001-02
ARE59C3-CAV*	0061-20	0008-74	0064-09	0037-13			0166-30	0001-71	0561-10	0561-10	C001-02
ARJ10K1-CAV*	0061-27	0036-03	0064-10	0037-14			0166-27	0001-68	0563-00	N/A	C001-00
ARJ11K1-CAV*	0061-20	0008-74	0064-03	0037-07			0166-22	0001-63	0604-05	0604-05	C001-00
ARJ11K2(E)-CAV*	0061-20	0008-74	0064-33	0037-50			0166-24	0001-65	0604-05	0604-05	C001-00
ARJ13K1-CAB*	0061-27	0036-03	0064-10	0037-14	0166-05	0140-06			0604-07	C100-10	C001-00
ARJ84C1(E)-IAV*	0061-27	0036-03			0172-02	C016-02			0604-03	C100-52	C001-00

A – Hermetic Compressors

AR - Compressor Parts

Model	Start Capacitor		Run Capacitor		Current Relay		Potential Relay		Overload		MTG Parts
	OEM	Service	OEM	Service	OEM	Service	OEM	Service	OEM	Service	
	(014-)	(914-)	(014-)	(914-)	(040-)	(940-)	(040-)	(940-)	(071-)	(971-)	
ARJ84C1-IAA*	0058-35	0036-08					0166-38	0001-80	0605-01	C100-06	C001-00
ARJ84C2(E)-IAA*	0058-35	0036-08					0166-38	0001-80	0605-01	C100-06	C001-00
ARJ84C2(E)-IAV*	0061-27	0036-03			0172-02	0102-04			0604-11	0604-11	C001-00
ART51C1(E)-IAA*	0053-35	0038-04			0171-04	C411-80			0603-02	C100-19	C001-00
ART51C1(E)-IAG*	0053-36	0038-05			0171-00	C411-58			0603-06	N/A	C001-00
ART51C1(E)-IAV*	0061-13	0008-65			0171-02	C411-79			0603-02	C100-19	C001-00
ART62C1(E)-IAA*	0053-25	0038-09			0163-05	0163-05			0603-05	C100-24	C001-00
ART62C1(E)-IAV*	0061-13	0008-65			0171-02	C411-79			0603-07	C100-58	C001-00
ART64C1(E)-IAA*	0053-25	0038-09			0163-07	0163-07			0603-10	C100-53	C001-00
ART64C1(E)-IAV*	0061-27	0036-03			0171-02	C411-79			0603-15	C100-54	C001-00
ART69C1-IAA*	0061-28	0036-04			0172-03	C016-03			0605-05	C100-71	C001-00
ART69C1-IAV*	0053-30	0053-14			0171-02	C411-79			0603-13	C100-72	C001-00
ART82C1-CAA*	0058-30	0036-04	0064-13	0037-17			0166-37	0001-79	0605-03	C100-09	C001-00
ART82C1-CAV*	0061-16	0008-70	0064-09	0037-13			0166-27	0001-68	0604-01	C103-01	C001-00
ART82C1-CFB*	0061-27	0036-03	0064-09	0037-13			0166-04	0140-05	IP	N/A	C001-00
ART97C1-CAA*	0061-33	0036-12	0064-11	0037-15			0166-03	0140-04	0605-02	C102-00	C001-00
ART97C1-CAV*	0061-16	0008-70	0064-09	0037-13			0166-27	0001-68	0604-08	0604-08	C001-00
ART97C1-PAV*	0036-13	0036-13	0064-10	0037-14			0166-27	0001-68	0604-06	C103-01	C001-00



AS - Compressor Parts

Model	Start Capacitor		Run Capacitor		Current Relay		Potential Relay		Overload		MTG Parts (527-)
	OEM	Service	OEM	Service	OEM	Service	OEM	Service	OEM	Service	
	(014-)	(914-)	(014-)	(914-)	(040-)	(940-)	(040-)	(940-)	(071-)	(971-)	
ASB12C3(E)-IAA*	0053-26	0053-10			0163-13	C411-72			0561-01	0561-01	C001-02
ASB14C3(E)-IAA*	0053-18	0053-00			0163-10	C411-82			0561-26	0554-12	C001-02
ASE12C4(E)-IAA*	0053-26	0053-10			0163-01	C411-66			0561-23	0554-19	C001-02
ASE14C4(E)-IAA*	0053-26	0053-10			0163-13	C411-72			0561-23	0554-19	C001-02
ASE19C3(E)-IAA*	0053-18	0053-00			0163-14	C411-71			0561-21	0554-28	C001-02
ASE19C4(E)-IAA*	0053-18	0053-00			0163-03	0150-32			0561-21	0554-28	C001-02
ASE20C4-IAA*	0053-26	0053-10			0163-13	C411-72			0561-21	0554-28	C001-02
ASE20C4E-CAA*	0061-28	0036-04	0064-10	0037-14			0166-21	0001-62	0561-21	0554-28	C001-02
ASE24C3(E)-IAA*	0053-26	0053-10			0163-10	C411-82			0561-07	0554-30	C001-02
ASE24C3(E)-IAV*	0053-27	0038-11			0150-04	C411-45			0561-29	0554-40	C001-02
ASE26C4(E)-CAA*	0072-02	0036-15	0064-11	0037-15			0166-21	0001-62	0561-03	0554-27	C001-02
ASE26C4(E)-IAA*	0053-35	0053-04			0163-04	C411-80			0561-03	0554-27	C001-02
ASE32C3(E)-CAA*	0061-20	0008-74	0064-10	0037-14			0166-45	0001-88	0561-07	0554-30	C001-02
ASE32C3(E)-CAV*	0061-27	0036-03	0064-09	0037-13			0166-13	0001-53	0561-12	0561-12	C001-02
ASE35C4(E)-CAA*	0072-02	0036-15	0064-12	0037-16			0166-37	0001-79	0561-49	0561-49	C001-02
ASE35C4(E)-IAA*	0053-35	0053-04			0163-05	C411-89			0561-49	0561-49	C001-02
ASE35C4-IAV*	0053-29	0053-13			0163-04	C411-80			0561-28	0554-42	C001-02
AST40C1(E)-IAA*	0061-28	0036-04			0172-03	C016-03			0605-05	C100-71	C001-02
AST40C1(E)-IAV*	0061-27	0036-03			0163-02	C411-79			0603-13	C100-72	C001-02
AST45C1(E)-CAV*	0061-16	0008-70	0064-09	0037-13			0166-03	0001-68	0604-01	C100-74	C001-00
AST45C1(E)-IAA*	0061-28	0036-04			0163-02	C016-03			0605-03	C100-09	C001-00
AST54C1(E)-CAA*	0061-33	0036-12	0064-11	0037-15			0166-03	0140-04	0605-04	C100-79	C001-00
AST54C1(E)-CAV*	0061-16	0008-70	0064-09	0037-13			0166-03	0001-68	0604-07	C100-10	C001-00



C – Hermetic Compressors

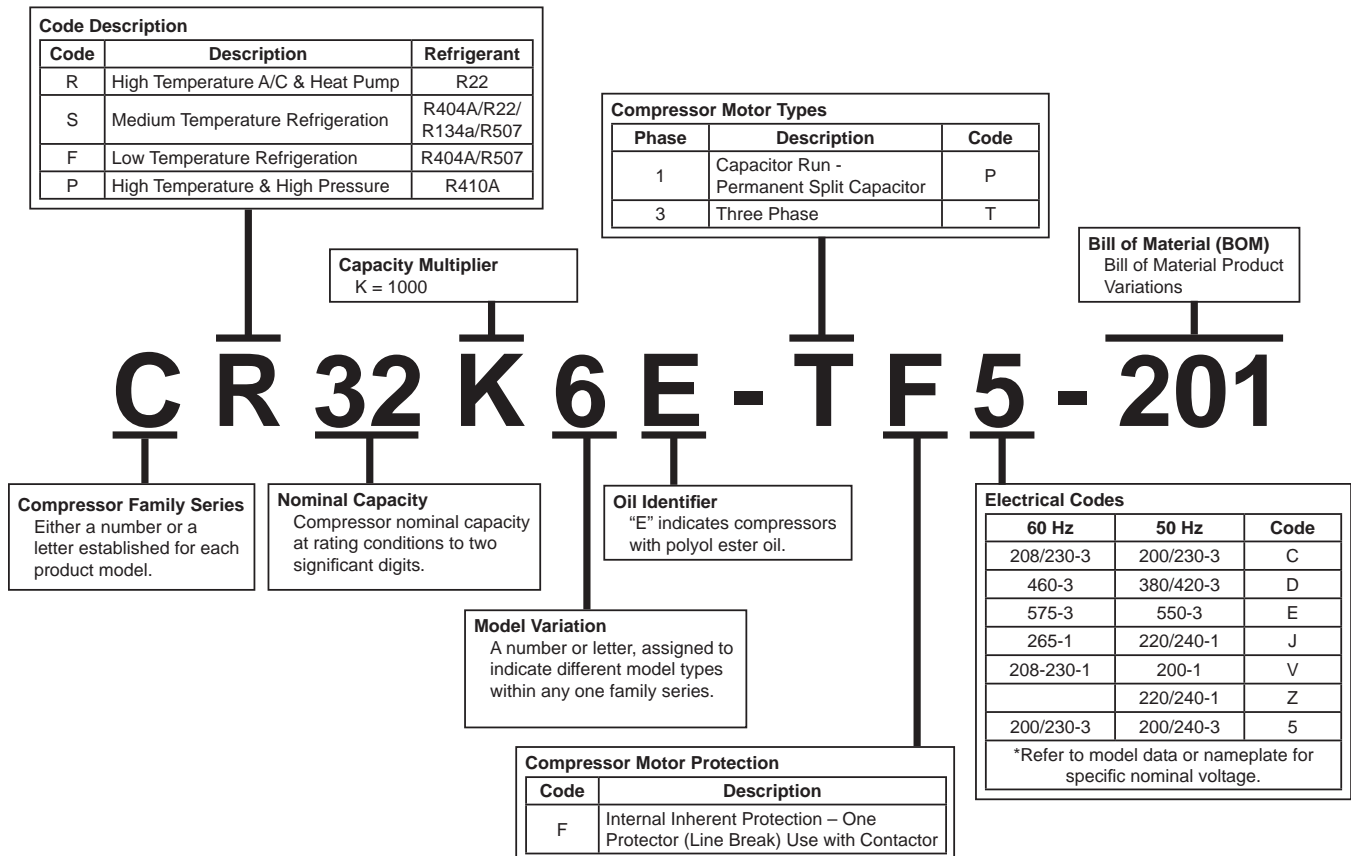
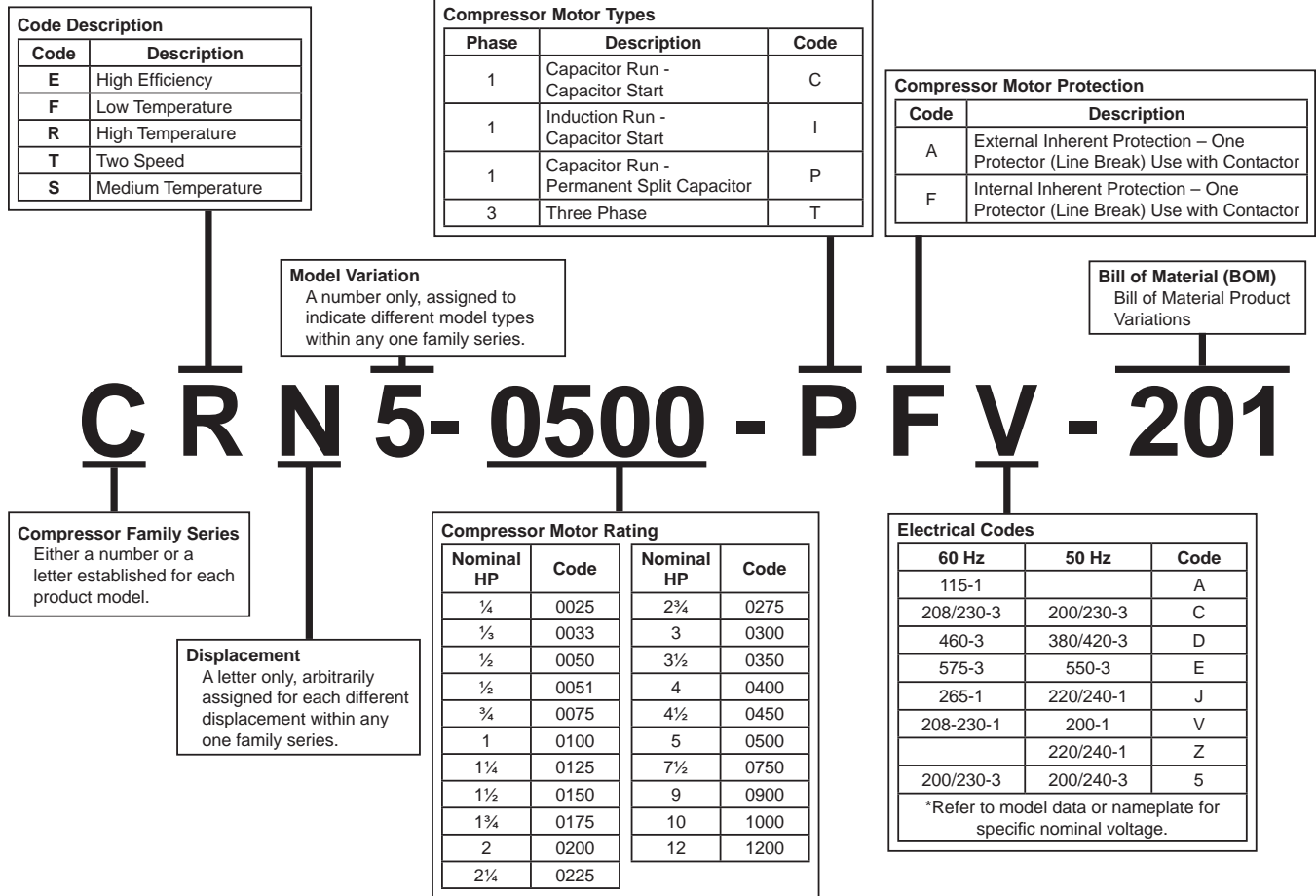

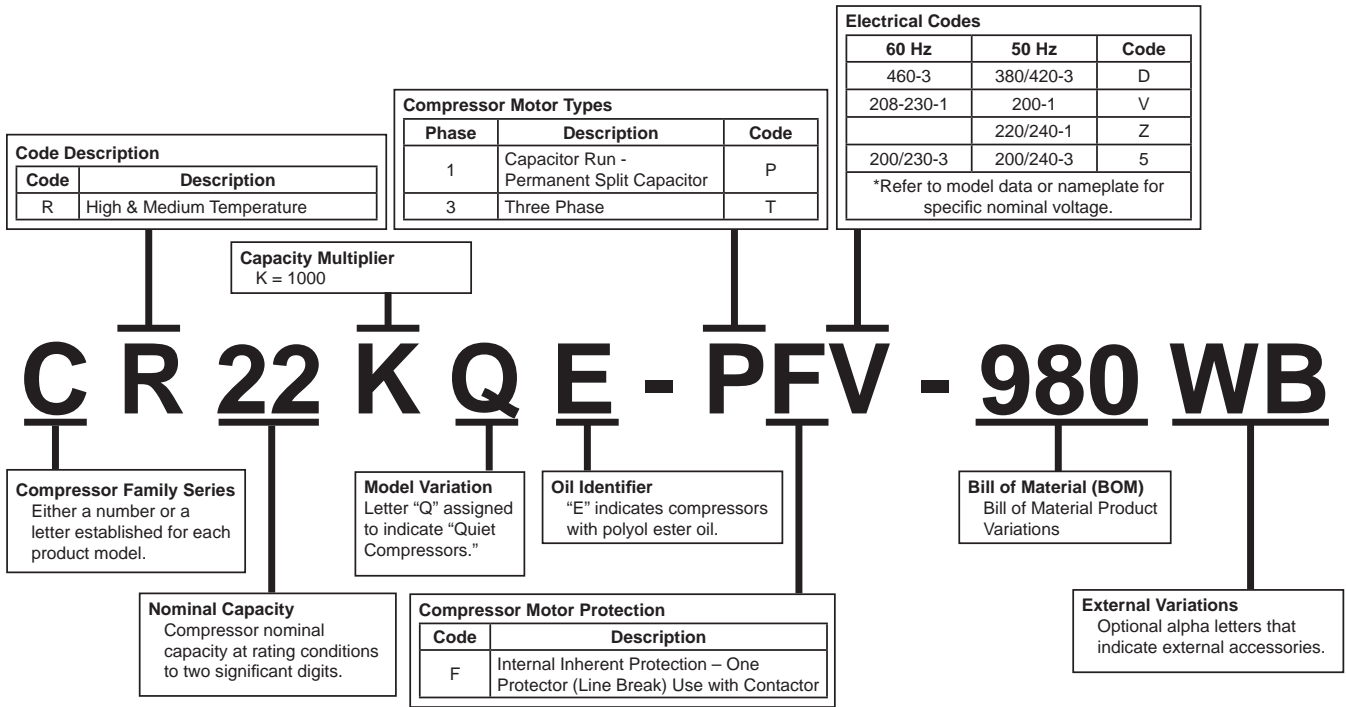

Crankcase Heaters

Application Code	Wrap Around Style		Voltage	Watts	Type
	OEM	Service			
	(018-)	(918-)			
1	018-0088-00	918-0088-00	240/265V	40/49	Wrap Around
1	018-0088-01	918-0088-01	480/575V	40/57	
2	018-0088-04	918-0088-04	240/265V	40/49	
2	018-0088-05	918-0088-05	480/575V	40/57	
3	018-0075-00	918-0037-02	240V	58	
3	018-0075-01	918-0037-03	480V	50	

* NOTE: 018-0031-05/918-0031-05 Crankcase Heaters used on previous models are no longer available.

Molded Plugs

Wire Gauge	Part Number
10	529-0060-04
14	529-0060-06

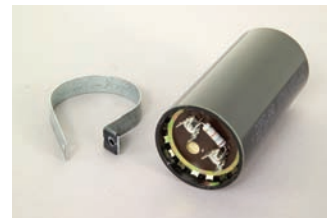

C – Hermetic Compressors

CF - Compressor Parts

Model	Start Capacitor		Run Capacitor		Relay		Crankcase Heater			MTG Parts (527-)
	OEM (014-)	Service (914-)	OEM (014-)	Service (914-)	OEM (040-)	Service (940-)	Insertion Style		Wrap Around	
							OEM (018-)	Service (918-)		
CF04K6E-PFV*	0061-04	0008-51	0064-06	0037-10	0166-15	0001-55	0088-00	0088-00	1	0044-08
CF04K6E-TF*							0088-00	0088-00	1	0044-08
CF06K6E-PFV*	0061-04	0008-51	0064-06	0037-10	0166-15	0001-55	0088-00	0088-00	1	0044-08
CF06K6E-TF*							0088-00	0088-00	1	0044-08
CF09K6E-PFV*	0061-28	0036-04	0064-08	0037-12	0166-15	0001-55	0088-00	0088-00	1	0044-08
CF09K6E-TF*							0088-00	0088-00	1	0044-08
CF12K6E-PFV*	0006-13	0006-03	0064-14	0037-18	0166-19	0001-60	0088-00	0088-00	1	0044-00
CF12K6E-TF*							0088-00	0088-00	1	0044-00

CR - Compressor Parts

Model	Start Capacitor		Run Capacitor		Relay		Crankcase Heater			MTG Parts (527-)
	OEM (014-)	Service (914-)	OEM (014-)	Service (914-)	OEM (040-)	Service (940-)	Insertion Style		Wrap Around	
							OEM (018-)	Service (918-)		
CR14K6(E)-PFV*	0061-28	0036-04	0064-07	0037-11	0166-15	0001-55	N/A	N/A	1	0044-08
CR16K6(E)-PFJ*	0061-27	0036-03	0064-05	0037-09	0166-15	0001-55	0088-00	0088-00	1	0044-08
CR16K6(E)-PFV*	0061-28	0036-04	0064-05	0037-09	0166-15	0001-55	0088-00	0088-00	1	0044-08
CR16KQ-PFV*	0006-16	0006-11	0064-11	0037-15	0166-15	0001-55	N/A	N/A	3	0044-08
CR18K6(E)-PFV*	0061-28	0036-04	0064-05	0037-09	0166-15	0001-55	0088-00	0088-00	1	0044-08
CR18KQ(E)-PFV*	0006-16	0006-11	0064-12	0037-16	0166-15	0001-55	N/A	N/A	3	0044-08
CR18KQ(E)-PFZ*	0006-16	0006-11	0064-11	0037-15	0166-15	0001-55	N/A	N/A	3	0044-08
CR18KQ(E)-TF*							N/A	N/A	3	0044-08
CR20K6(E)-PFV*	0061-04	0008-51	0064-06	0037-16	0166-19	0001-60	0088-00	0088-00	1	0044-08
CR20KQ(E)-PFV*	0061-28	0006-11	0064-06	0037-16	0166-15	0001-55	N/A	N/A	3	0044-08
CR22K6(E)-PFV*	0061-04	0008-51	0064-06	0037-10	0166-19	0001-60	N/A	N/A	1	0044-08
CR22K6(E)-TF*							0088-00	0088-00	1	0044-08
CR22KQ(E)-PFV*	0061-13	0006-11	0064-13	0037-17	0166-15	0001-87	N/A	N/A	3	0044-08
CR22KQ(E)-TF*							N/A	N/A	3	0044-08
CR24K6(E)-PFV*	0061-28	0006-11	0064-07	0037-11	0166-15	0001-55	0088-00	0088-00	1	0044-08
CR24K6(E)-TF*							N/A	N/A	1	0044-08
CR24KQ(E)-PFV*	0006-16	0006-11	0064-13	0037-17	0166-15	0001-55	N/A	N/A	3	0044-08
CR32KQ(E)-PFV*	0061-28	0036-04	0064-13	0037-17	0166-15	0001-55	N/A	N/A	3	0044-08
CR32KQ(E)-TF*							N/A	N/A	3	0044-08
CR33KQ(E)-PFV*	0006-13	0006-03	0064-14	0037-18	0166-14	0001-54	0088-00	0088-00	N/A	0044-08
CR33KQ(E)-TF*							0088-00	0088-00	N/A	0044-08
CR34K6(E)-PFV*	0006-13	0006-03	0064-29	0037-18	0166-15	0001-55	0088-00	0088-00		0044-08
CR34KQ(E)-PFV*	0006-13	0006-03	0064-29	0037-18	0166-14	0001-54	0088-00	0088-00	N/A	0044-08
CR34KQ(E)-TF*							0088-00	0088-00	N/A	0044-08
CR35K6(E)-PFV*	0006-13	0006-03	0064-08	0037-12	0166-15	0001-55	0088-00	0088-00	1	0044-08
CR35K6(E)-TF*							0088-00	0088-00	1	0044-08

CR - Compressor Parts

Model	Start Capacitor		Run Capacitor		Relay		Crankcase Heater			MTG Parts (527-)
	OEM (014-)	Service (914-)	OEM (014-)	Service (914-)	OEM (040-)	Service (940-)	Insertion Style		Wrap Around	
							OEM (018-)	Service (918-)		
CR36KQ(E)-PFV*	0006-13	0006-03	0064-14	0037-18	0166-14	0001-54	0088-00	0088-00	N/A	0044-08
CR36KQ(E)-TF*							0088-00	0088-00	N/A	0044-08
CR37KQ(E)-PFV*	0006-13	0006-03	0064-08	0037-12	0166-19	0001-60	0088-00	0088-00	N/A	0044-08
CR37KQ(E)-TF*							0088-00	0088-00	N/A	0044-08
CR38K6(E)-PFV*	0006-13	0006-03	0064-14	0037-18	0166-19	0001-60	0088-00	0088-00	1	0044-08
CR38K6(E)-TF*							0088-00	0088-00	1	0044-08
CR41KQ(E)-PFV*	0006-13	0006-03	0064-16	0037-20	0166-27	0001-68	0088-00	0088-00	N/A	0044-08
CR41KQ(E)-TF*							0088-00	0088-00	N/A	0044-08
CR24KQ(E)-PFZ*	0006-16	0006-11	0064-13	0037-17	0166-15	0001-55	N/A	N/A	3	0044-08
CR24KQ(E)-TF*							N/A	N/A	3	0044-08
CR28K6(E)-PFJ*	0061-26	0036-02	0064-07	0037-11	0166-15	0001-54	0088-00	0088-00	1	0044-08
CR28K6(E)-PFV*	0061-04	0008-51	0064-07	0037-11	0166-19	0001-60	0088-00	0088-00	1	0044-08
CR28K6(E)-PFJ*	0061-26	0036-02	0064-13	0037-17	0166-15	0001-55	0088-00	0088-00	1	0044-08
CR28K6(E)-TF*							0088-00	0088-00	1	0044-08
CR28KQ(E)-PFV*	0006-16	0006-11	0064-13	0037-11	0166-15	0001-55	N/A	N/A	3	0044-08
CR28KQ(E)-PFZ*	0006-16	0006-11	0064-14	0037-18	0166-15	0001-54	N/A	N/A	3	0044-08
CR28KQ(E)-TF*							N/A	N/A	3	0044-08
CR30K6(E)-PFJ*	0061-28	0036-04	0064-14	0037-18	0166-15	0001-55	0088-00	0088-00	1	0044-08
CR30K6(E)-PFV*	0061-28	0036-04	0064-07	0037-11	0166-15	0001-54	0088-00	0088-00	1	0044-08
CR30KQ(E)-PFV*	0006-16	0006-11	0064-13	0037-17	0166-15	0001-55	N/A	N/A	3	0044-08
CR30KQ(E)-TF*							N/A	N/A	3	0044-08
CR32K6(E)-PFJ*	0061-28	0036-04	0064-08	0037-12	0166-14	0001-54	0088-00	0088-00	1	0044-08
CR32K6(E)-PFV*	0061-28	0036-04	0064-13	0037-17	0166-14	0001-54	0088-00	0088-00	1	0044-08
CR32K6(E)-TF*							0088-00	0088-00	1	0044-08
CR42K6(E)-PFV*	0006-13	0006-03	0064-14	0037-18	0166-27	0001-68	0088-00	0088-00	1	0044-08
CR42K6(E)-TF*							0088-00	0088-00	1	0044-08
CR47KQ(E)-PFV*	0006-13	0006-03	0064-15	0037-19	0166-18	0001-59	0088-00	0088-00	N/A	0044-00
CR47KQ(E)-TF*							0088-00	0088-00	N/A	0044-00
CR53KQ(E)-PFV*	0006-13	0006-03	0064-18	0037-22	0166-18	0001-59	0088-00	0088-00	N/A	0044-00
CR53KQ(E)-TF*							0088-00	0088-00	N/A	0044-00
CR60KQ-PFV*	0006-13	0006-03	0064-15	0037-19	0166-27	0001-68	0088-00	0088-00	2	0044-00
CR60KQ-TF*							0088-00	0088-00	2	0044-00
CR60K5-PFV*	0006-13	0006-03	0064-15	0037-19	0166-27	0001-68	0088-00	0088-00	2	0044-00
CR60K5-TF*							0088-00	0088-00	2	0044-00
CRA1-0150-PFV*	0061-28	0036-04	0064-05	0037-09	0166-15	0001-55	0088-00	0088-00	N/A	0044-08
CRA1-0150-TF*							0088-00	0088-00	N/A	0044-08
CRB1-0175-PFV*	0061-28	0036-04	0064-05	0037-09	0166-15	0001-55	0088-00	0088-00	N/A	0044-08
CRC1-0175-PFV*	0061-28	0008-51	0064-06	0037-10	0166-15	0001-56	0088-00	0088-00	N/A	0044-08
CRC1-0175-TF*							0088-00	0088-00	N/A	0044-08
CRD1-0200-PFV*	0061-28	0036-04	0064-07	0037-11	0166-15	0001-55	0088-00	0088-00	N/A	0044-08
CRD1-0200-TF*							0088-00	0088-00	N/A	0044-08
CRE1-0225-TF*							0088-00	0088-00	N/A	0044-08

C – Hermetic Compressors

CR - Compressor Parts

Model	Start Capacitor		Run Capacitor		Relay		Crankcase Heater			MTG Parts (527-)
	OEM (014-)	Service (914-)	OEM (014-)	Service (914-)	OEM (040-)	Service (940-)	Insertion Style		Wrap Around	
							OEM (018-)	Service (918-)		
CRE2-0225-PFV*	0061-28	0036-04	0064-07	0037-11	0166-15	0001-55	0088-00	0088-00	N/A	0044-08
CRF2-0250-PFV*	0035-20	0036-04	0064-07	0037-11	0166-15	0001-55	0088-00	0088-00	N/A	0044-08
CRG3-0250-PFV*	0061-28	0036-04	0064-08	0037-12	0166-15	0001-55	0088-00	0088-00	N/A	0044-08
CRG3-0250-TF*							0088-00	0088-00	N/A	0044-08
CRH3-0275-PFV*	0006-13	0006-03	0064-08	0037-12	0166-15	0001-55	0088-00	0088-00	N/A	0044-08
CRH3-0275-TF*							0088-00	0088-00	N/A	0044-08
CRJ3-0300-PFV*	0006-13	0006-03	0064-13	0037-17	0166-14	0001-54	0088-00	0088-00	N/A	0044-08
CRJ3-0300-TF*							0088-00	0088-00	N/A	0044-08
CRK3-0325-PFV*	0006-13	0006-03	0064-14	0037-18	0166-23	0001-64	0088-00	0088-00	N/A	0044-08
CRK3-0325-TF*							0088-00	0088-00	N/A	0044-08
CRL3-0350-PFV*	0006-13	0006-03	0064-14	0037-18	0166-23	0001-64	0088-00	0088-00	N/A	0044-08
CRL3-0350-TF*							0088-00	0088-00	N/A	0044-08
CRM3-0400-PFV*	0006-13	0006-03	0064-16	0037-20	0166-22	0001-68	0088-00	0088-00	N/A	0044-08
CRM3-0400-TF*							0088-00	0088-00	N/A	0044-08
CRN5-0500-PFV*	0006-15	0006-10	0064-17	0037-21	0166-27	0001-68	0088-00	0088-00	2	0116-00
CRN5-0500-T*							0088-00	0088-00	2	0116-00
CRNQ-050(E)-PFV*	0006-15	0006-10	0064-17	0037-21	0166-27	0001-68	0088-00	0088-00	2	0116-00
CRNQ-050(E)-TF*							0088-00	0088-00	2	0116-00
CRP5-0450-PFV*	0006-13	0006-03	0064-15	0037-19	0166-27	0001-68	0088-00	0088-00	2	0116-00
CRP5-0450-TF*							0088-00	0088-00	2	0116-00
CRPQ-0450-PFV*	0006-13	0006-03	0064-15	0037-19	0166-27	0001-68	0088-00	0088-00	2	0116-00
CRPQ-0450-TF*							0088-00	0088-00	2	0116-00
CRT5-0450-PFV*	0006-13	0006-03	0064-15	0037-19	0166-27	0001-68	0088-00	0088-00	2	0116-00
CRT5-0450-TF*							0088-00	0088-00	2	0116-00
CRTQ-0450-PFV*	0006-13	0006-03	0064-15	0037-19	0166-27	0001-68	0088-00	0088-00	2	0116-00
CRTQ-0450-TF*							0088-00	0088-00	2	0116-00



CR



CS



CT

CS - Compressor Parts

Model	Start Capacitor		Run Capacitor		Relay		Crankcase Heater			MTG Parts (527-)
	OEM (014-)	Service (914-)	OEM (014-)	Service (914-)	OEM (040-)	Service (940-)	Insertion Style		Wrap Around	
							OEM (018-)	Service (918-)		
CS07KQE-PFV*	0061-28	0036-04	0064-06	0037-10	0166-15	0001-55	0088-00	0088-00	1	0044-08
CS07KQE-TF*							0088-00	0088-00	1	0044-08
CS08KQE-PFV*	0061-28	0036-04	0064-06	0037-10	0166-15	0001-55	0088-00	0088-00	1	0044-08
CS08KQE-TF*							0088-00	0088-00	1	0044-08
CS10K6E-PFV*	0061-04	0008-51	0064-06	0037-10	0166-19	0001-60	0088-00	0088-00	1	0044-08
CS10K6E-TF*							0088-00	0088-00	1	0044-08
CS12K6E-PFJ*	0061-26	0036-02	0064-12	0037-16	0166-15	0001-55	0088-00	0088-00	1	0044-08
CS12K6E-PFV*	0061-04	0008-51	0064-06	0037-10	0166-19	0001-60	0088-00	0088-00	1	0044-08
CS12K6E-TF*							0088-00	0088-00	1	0044-08
CS13K6E-PFV*	0006-13	0006-03	0064-13	0037-17	0166-15	0001-55	0088-00	0088-00	1	0044-08
CS13K6E-TF*							0088-00	0088-00	1	0044-08
CS14K6E-PFV*	0061-28	0036-04	0064-07	0037-11	0166-15	0001-55	0088-00	0088-00	1	0044-08
CS14K6E-TF*							0088-00	0088-00	1	0044-08
CS16K6E-PFV*	0006-13	0006-03	0064-13	0037-17	0166-15	0001-55	0088-00	0088-00	1	0044-08
CS16K6E-TF*							0088-00	0088-00	1	0044-08
CS17K6E-PFV*	0061-27	0036-03	0064-13	0037-17	0166-14	0001-54	0088-00	0088-00	1	0044-08
CS18K6E-PFV*	0061-28	0036-04	0064-07	0037-11	0166-15	0001-55	0088-00	0088-00	1	0044-08
CS18K6E-TF*							0088-00	0088-00	1	0044-08
CS20K6E-PFV*	0006-13	0006-03	0064-08	0037-12	0166-15	0001-55	0088-00	0088-00	1	0044-08
CS20K6E-TF*							0088-00	0088-00	1	0044-08
CS24K6E-PFV*	0006-13	0006-03	0064-14	0037-18	0166-23	0001-64	0088-00	0088-00	1	0044-08
CS24K6E-TF*							0088-00	0088-00	1	0044-08
CS27K3E-PFV*	0006-13	0006-03	0064-14	0037-18	0166-23	0001-55	0088-00	0088-00	1	0044-08
CS27K3E-TF*							0088-00	0088-00	1	0044-08
CS27K6E-PFV*	0006-13	0006-03	0064-14	0037-18	0166-23	0001-55	0088-00	0088-00	1	0044-08
CS27K6E-TF*							0088-00	0088-00	1	0044-08
CS33K3E-PFV*	0006-13	0006-03	0064-16	0037-20	0166-27	0001-68	0088-00	0088-00	1	0044-08
CS33K3E-TF*							0088-00	0088-00	1	0044-08
CS33K6E-PFV*	0006-13	0006-03	0064-16	0037-20	0166-27	0001-68	0088-00	0088-00	1	0044-08
CS33K6E-TF*							0088-00	0088-00	1	0044-08

CT - Compressor Parts

Model	Start Capacitor		Run Capacitor		Relay		Crankcase Heater			MTG Parts (527-)
	OEM (014-)	Service (914-)	OEM (014-)	Service (914-)	OEM (040-)	Service (940-)	Insertion Style		Wrap Around	
							OEM (018-)	Service (918-)		
CTH1-0275-CSV*	0006-16	0006-11	0064-13	0037-17	0166-41	0001-84	0088-00	0088-00	0044-08	
CTL1-0350-CSV*	0006-16	0006-11	0064-15	0037-19	0166-43	0001-86	0088-00	0088-00	0044-08	
CTL1-0350-TS*							0088-00	0088-00	0044-08	
CTN1-0500-TS*							0088-00	0088-00	0044-08	
CTN1-0501-CSV*	0006-17	0006-12	0064-17	0037-21	0166-42	0001-85	0088-00	0088-00	0044-08	

Note: 2 speed CT compressors are obsolete and replacement compressors are no longer available.

R – Hermetic Compressors

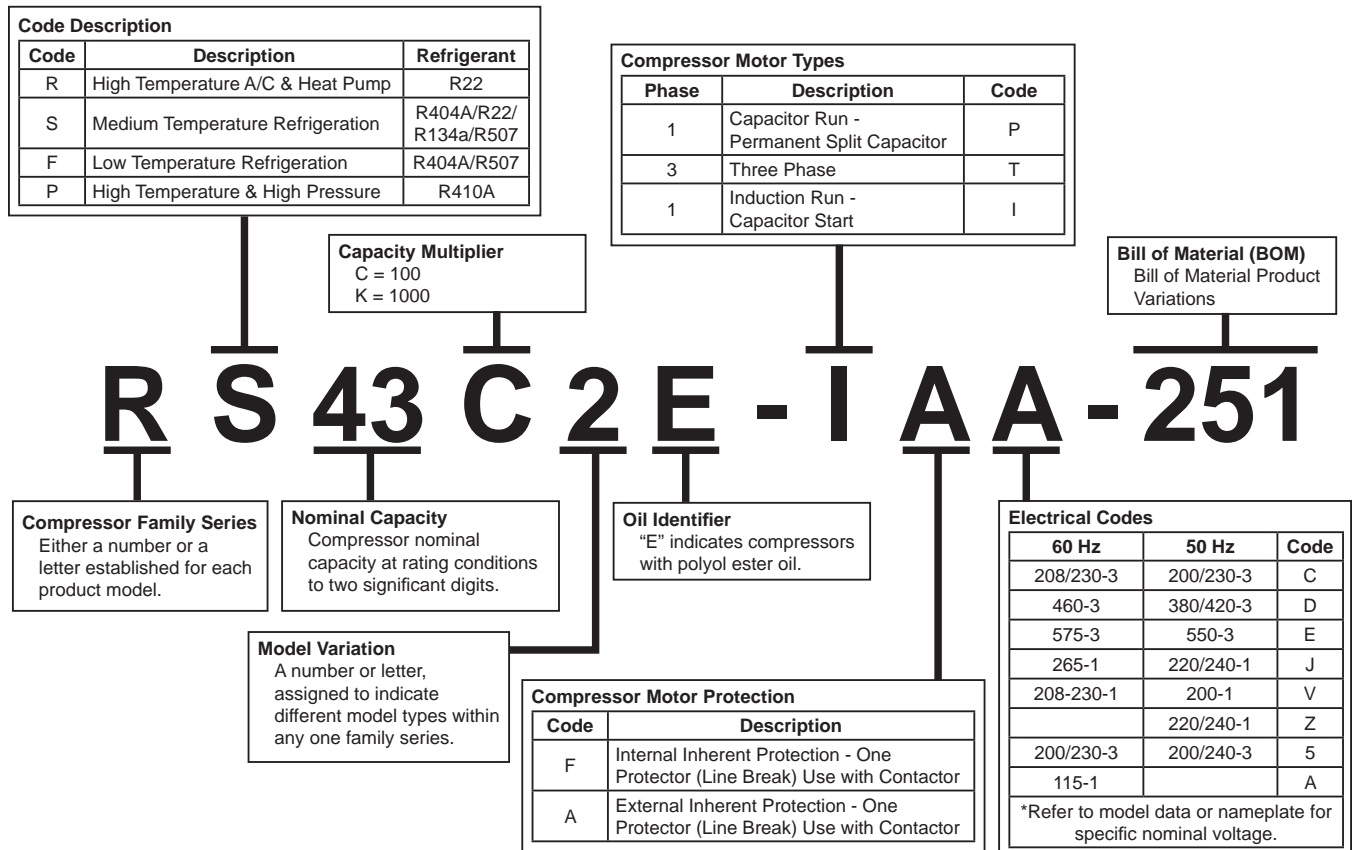
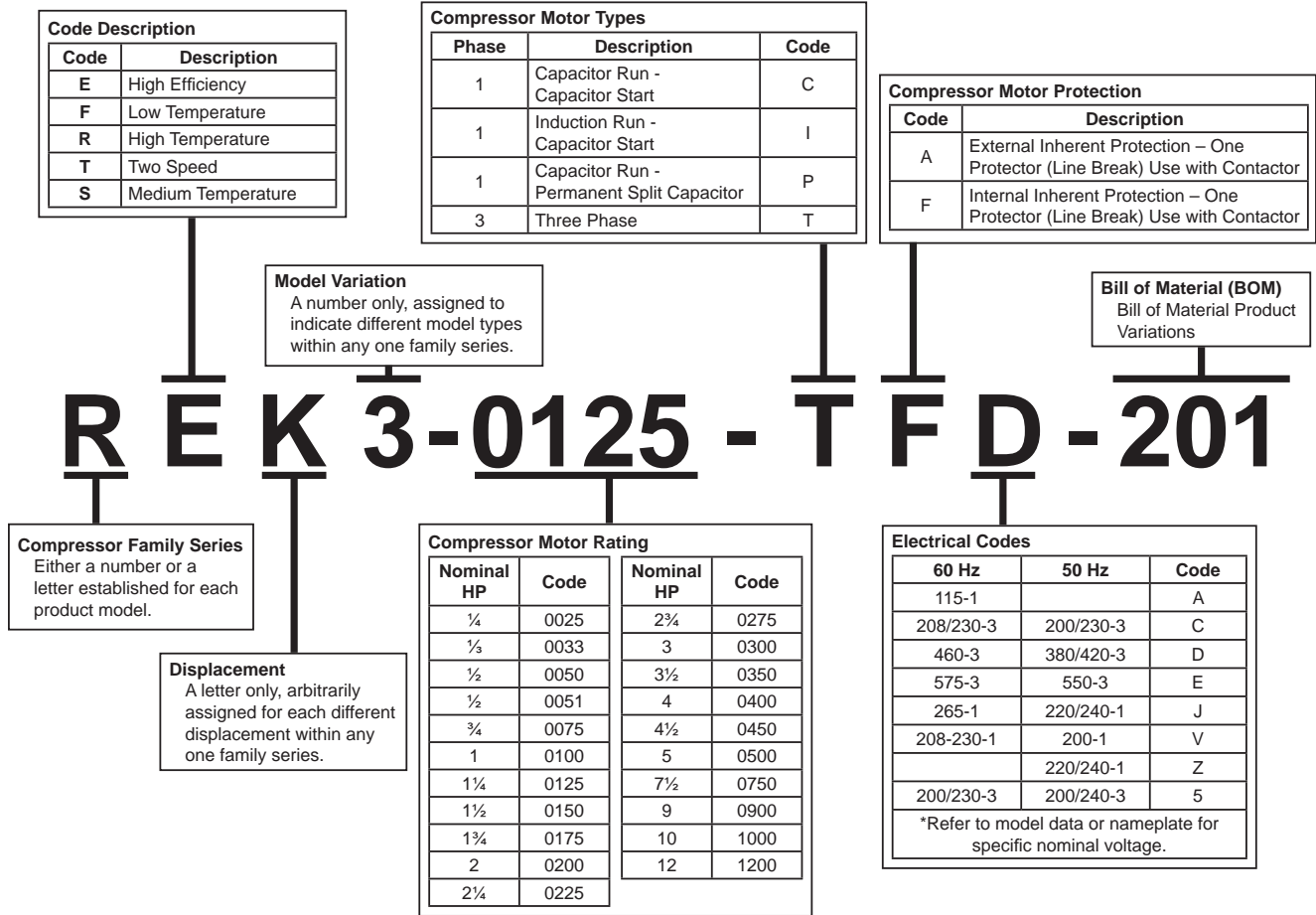

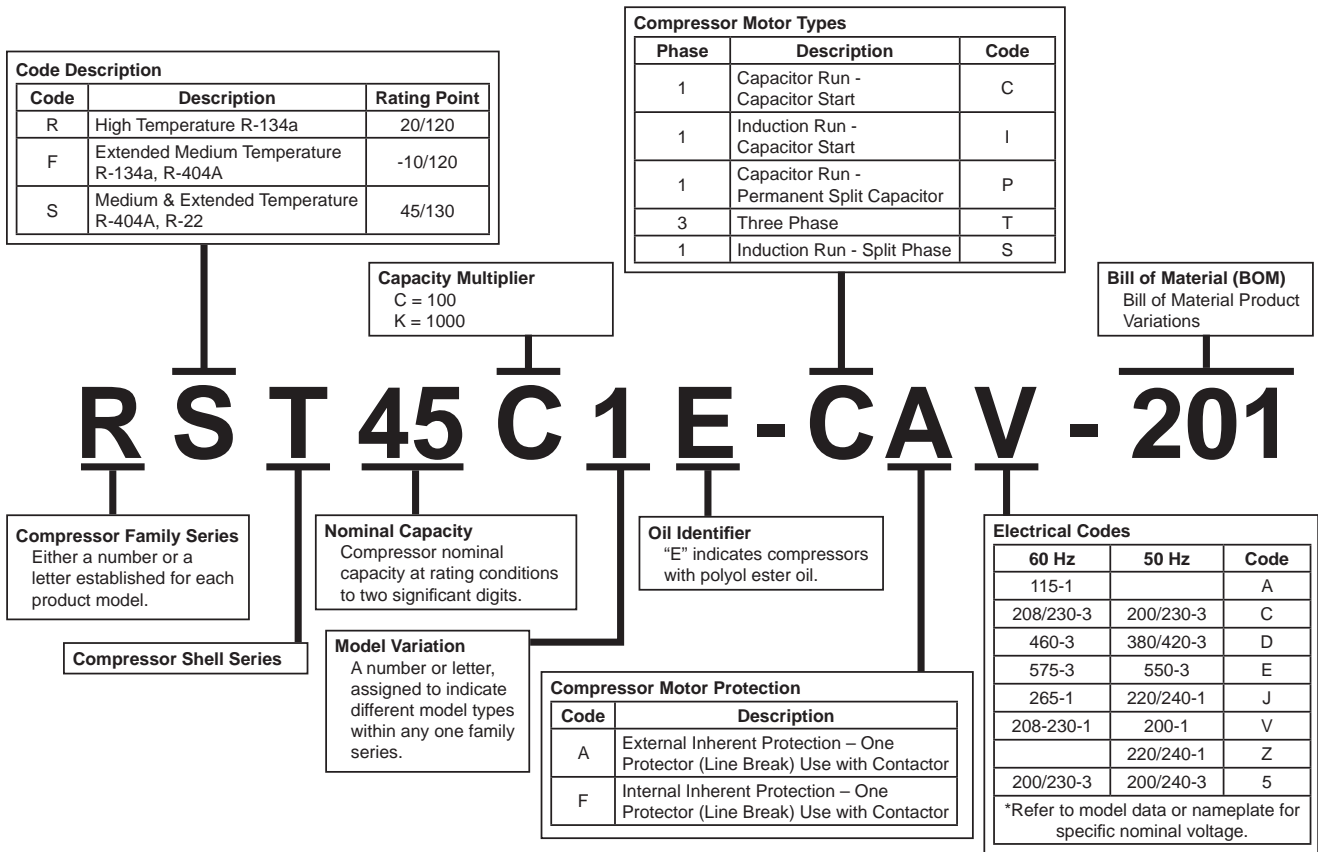

Crankcase Heaters

Application Code	OEM	Service	Voltage	Watts	Lead Length
	(018-)	(918-)			
#1	0089-00	0038-00	120V	48 WATT	49" Lead
#1	0089-02	0038-01	240V	48 WATT	49" Lead
#2	0097-00	0097-00	120V	20 WATT	49" Lead
#2	0097-01	0097-01	240V	20 WATT	49" Lead



RR



R – Hermetic Compressors

RE - Compressor Parts

Model	Start Capacitor		Run Capacitor		Relay		Protector	Crankcase Heater	MTG Parts
	OEM	Service	OEM	Service	OEM	Service			
	(014-)	(914-)	(014-)	(914-)	(040-)	(940-)			
REB3-0150-PFV*	0061-14	0008-66	0064-05	0037-09	0166-19	0001-60	IP	1	0039-04
REK3-0125-PFV*	0061-14	0008-66	0064-05	0037-09	0166-19	0001-60	IP	1	0039-04
REK3-0125-TFC*							IP	1	0039-04
REL3-0200-PFV*	0061-18	0008-72	0064-05	0037-09	0166-19	0001-60	IP	1	0039-04
RES3-0175-PFV*	0061-20	0008-74	0064-05	0037-09	0166-19	0001-60	IP	1	0039-04
REY3-0175-PFV*	0061-20	0008-74	0064-06	0037-10	0166-19	0001-60	IP	1	0039-04
REY3-0175-TFC*							IP	1	0039-04
REZ3-0125-PFV*	0061-14	0008-66	0064-04	0037-08	0166-19	0001-60	IP	1	0039-04

RF - Compressor Parts

Model	Start Capacitor		Run Capacitor		Relay		Protector		Crankcase Heater	MTG Parts
	OEM	Service	OEM	Service	OEM	Service	OEM	Service		
	(014-)	(914-)	(014-)	(914-)	(040-)	(940-)	(071-)	(971-)		
RF18C1(E)-IAA*	0061-22	0008-79			0166-21	0088-04	0127-06	0127-06	1	0039-04
RF18C1(E)-IAV*	0061-18	0008-72			0166-22	0088-07	0329-26	0329-26	1	0039-04
RF18C2(E)-IAA*	0061-22	0008-79			0166-21	0088-04	0127-06	0127-06	1	0039-04
RF18C2(E)-IAV*	0061-88	0008-72			0166-22	0088-07	0329-26	0329-26	1	0039-04
RF40C1E-CAA*	0061-27	0036-03	0064-08	0037-12	0166-14	0001-54	0518-03		1	0039-04
RF40C1E-CAV*	0061-12	0008-64	0064-00	0037-04	0166-14	0001-54	0527-07		1	0039-04
RF41C1-CAA*	0061-17	0008-71	0064-07	0037-11	0166-15	0001-55	0518-09		1	0039-04
RF41C1-CAV*	0061-14	0008-66	0064-10	0037-06	0166-14	0001-54	0518-10		1	0039-04
RF41C5E-CAA*	0061-27	0036-03	0064-08	0037-12	0166-14	0001-54	0518-03		1	0039-04
RF41C5E-CAV*	0061-14	0008-66	0064-02	0037-06	0166-14	0001-54	0518-10		1	0039-04
RF42C1E-CAA*	0061-27	0036-03	0064-05	0037-09	0166-19	0001-60	0127-46	0127-46	1	0039-04
RF42C1E-CAV*	0006-13	0006-03	0064-10	0037-14	0166-14	0001-54	0127-37	0127-37	1	0039-04
RFT18C1E-PFA*	0006-08	0036-16	0064-08	0037-12	0166-38	0001-80	IP		2	C001-00
RFT22C1E-CAA*	0061-32	0036-09	0064-13	0037-17	0166-21	0001-62	0604-13	0604-13	2	C001-00
RFT22C1E-CAV*	0061-20	0008-74	0064-36	0037-55	0166-39	0001-82	0561-01	0561-01	2	C001-00
RFT22C1E-IAA*	0061-32	0036-09			0172-03	C016-03	0645-00	N/A	2	C001-00
RFT22C1E-IAV*	0053-27	0053-11			0150-46	N/A	0561-28	0554-02	2	C001-00
RFT26C1E-CAA*	0061-32	0036-09	0064-13	0037-17	0166-21	0001-62	0604-18	0604-18	2	C001-00
RFT26C1E-CAV*	0061-20	0008-74	0064-09	0037-13	0166-13	0001-53	0561-71	0561-71	2	C001-00
RFT26C1E-IAA*	0061-32	0036-09			0172-03	C016-03	0605-10	0605-10	2	C001-00
RFT26C1E-IAV*	0053-27	0053-11			0150-43	N/A	0561-24	0554-17	2	C001-00
RFT29C1E-CAA*	0061-32	0036-09	0064-13	0037-17	0166-21	0001-62	0604-16	0604-16	2	C001-00
RFT29C1E-CAV*	0061-30	0036-07	0064-36	0037-55	0166-29	0001-70	0561-28	0554-42	2	C001-00
RFT29C1E-IAA*	0061-32	0036-09			0172-03	C016-03	0605-05	C100-71	2	C001-00
RFT29C1E-IAZ*	0053-26	0053-10			0163-15	0150-31	0561-24	0554-17	2	C001-00
RFT32C1E-CAA*	0061-32	0036-09	0064-13	0037-17	0166-37	0001-79	0605-09	0605-09	2	C001-00
RFT32C1E-CAV*	0061-27	0036-03	0064-09	0037-13	0166-30	0001-71	0561-28	0554-42	2	C001-00
RFT32C1E-IAA*	0061-32	0036-09			0166-37	0001-79	0605-08		2	C001-00
RFT32C1E-IAZ*	0061-26	0036-02	0064-09	0037-13	0166-26	0166-26	0561-62	0561-62	2	C001-00
RFT42C1E-PFA*	0006-18	0036-16	0064-38	0037-54	0046-26	0046-26	IP		2	C001-00
RFT42C1E-PFV*	0061-30	0036-07	0064-11	0037-15	0166-13	0166-13	IP		2	C001-00
RFT42C1E-PFZ*	0061-27	0036-03	0064-10	0037-14	0166-46	0001-89	IP		2	C001-00

RR - Compressor Parts

Model	Start Capacitor		Run Capacitor		Relay		Protector		Crankcase Heater	MTG Parts (527-)
	OEM	Service	OEM	Service	OEM	Service	OEM	Service		
	(014-)	(914-)	(014-)	(914-)	(040-)	(940-)	(071-)	(971-)		
RR10K1(E)-CAA*	0061-16	0008-78	0064-06	0037-10	0166-14	0001-54	0127-30	0127-30	1	0039-04
RR10K1(E)-CAV*	0061-14	0008-66	0064-02	0037-06	0166-14	0001-54	0127-05	0127-05	1	0039-04
RR10K2(E)-CAA*	0061-21	0008-78	0064-06	0037-10	0166-14	0001-54	0127-30	0127-30	1	0039-04
RR10K2(E)-CAV*	0061-14	0008-66	0064-02	0037-06	0166-14	0001-54	0127-05	0127-05	1	0039-04
RR12K1-PFV*	0061-14	0008-66	0064-04	0037-08	0166-19	0001-60	IP		1	0039-04
RR14K1-PFJ*	0061-27	0006-02	0064-05	0037-09	0166-14	0001-54	IP		1	0039-04
RR14K1-PFV*	0061-14	0008-66	0064-06	0037-10	0166-19	0001-60	IP		1	0039-04
RR16K1-PFJ*	0061-16	0008-78	0064-11	0037-15	0166-15	0001-55	IP		1	0039-04
RR16K1-PFV*	0061-20	0008-74	0064-11	0037-15	0166-19	0001-60	IP		1	0039-04
RR17K1-PFJ*	0061-20	0008-74	0064-12	0037-16	0166-14	0001-54	IP		1	0039-04
RR17K1-PFV*	0061-16	0008-78	0064-06	0037-10	0166-37	0001-79	IP		1	0039-04
RR17K1-TFC*							IP		1	0039-04
RR20K1-PFV*	0061-12	0008-72	0064-11	0037-15	0166-19	0001-60	IP		1	0039-04
RR81C1(E)-IAA*	0061-17	0008-71			0166-38	0088-04	0127-18	0127-18	1	0039-04
RR81C1(E)-IAV*	0061-18	0008-72			0166-19	0001-60	0329-07	0329-07	1	0039-04
RR81C2(E)-IAA*	0062-17	0008-71			0166-38	0088-04	0127-18	0127-18	1	0039-04
RR81C2(E)-IAV*	0061-18	0008-72			0166-19	0001-60	0329-07	0329-07	1	0039-04
RRG4-0100-PAA*	0061-01	0008-48	0064-11	0037-15	0166-19	0001-60	0127-40	0127-40	1	0039-04
RRG4-0100-PAV*	0061-18	0008-72	0064-02	0037-06	0166-14	0001-54	0329-00	0329-00	1	0039-04
RRK4-0126-PAA*	0061-13	0008-65	0064-06	0037-10	0166-19	0001-60	0127-18	0127-18	1	0039-04
RRL4-0100-CAA*	0061-25	0008-74	0064-02	0037-06	0166-15	0001-55	0127-38	N/A	1	0039-04
RRL4-0100-CAV*	0061-14	0008-66	0064-02	0037-06	0166-32	0001-54	0127-05	0127-05	1	0039-04
RRS4-0075-IAA*	0061-17	0008-71			0168-13	0088-04	0127-18	0127-18	1	0039-04
RRS4-0075-IAV*	0061-18	0008-72			0166-19	0001-60	0329-07	0329-07	1	0039-04
RRT10K1E-PFA*	0006-18	0036-16	0064-08	0037-12	0046-26	0046-26	IP		2	C001-00
RRT10K1E-PFV*	0061-29	0036-05	0064-11	0037-15	0166-27	0001-68	IP		2	C001-00
RRT10K1E-PFZ*	0061-27	0036-03	0064-10	0037-14	0166-45	0001-88	IP		2	C001-00
RRT62C1E-IAA	0053-18	0053-00			0163-05	C411-89	0561-61	N/A	2	C001-00
RRT62C1E-IAV	0053-29	0053-13			0163-11	C411-63	0561-62	0561-62	2	C001-00
RRT64C1E-CAA	0058-43		0064-13	0037-17	0166-03	0140-04	0561-60	0561-60	2	C001-00
RRT64C1E-CAV	0061-13	0008-65							2	C001-00
RRT64C1E-IAA	0058-43	N/A			0172-04	N/A	0561-59	N/A	2	C001-00
RRT64C1E-IAV	0053-29	0053-13			0163-15	0150-31	0561-74	0561-74	2	C001-00
RRT73C1E-CAA	0061-32	0036-09	0064-13	0037-17	0166-21	0001-62	0645-04	N/A	2	C001-00
RRT73C1E-CAV	0061-20	0008-74	0064-09	0037-13	0166-13	0001-53	0561-28	0554-42	2	C001-00
RRT73C1E-IAA	0061-32	0036-09			0172-03	C016-03	0644-03	N/A	2	C001-00
RRT73C1E-IAV	0053-30	0053-14			0163-01	0150-34	0561-68	0561-68	2	C001-00
RRT81C1E-PFA	0006-18	0036-16	0064-08	0037-12	0166-38	0001-80	IP		2	C001-00
RRT81C1E-PFV	0061-27	0036-03	0064-10	0037-14	0166-45	0001-88	IP		2	C001-00
RRT81C1E-PFZ	0061-27	0036-03	0064-11	0037-15	0166-36	0001-78	IP		2	C001-00

R – Hermetic Compressors

RS - Compressor Parts

Model	Start Capacitor		Run Capacitor		Current Relay		Potential Relay		Protector		Crankcase Heater	MTG Parts (527-)
	OEM	Service	OEM	Service	OEM	Service	OEM	Service	OEM	Service		
	(014-)	(914-)	(014-)	(914-)	(040-)	(940-)	(040-)	(940-)	(071-)	(971-)		
RS40C1(E)-IAA*	0061-17	0008-71			0168-10	0088-00	0166-21	0001-62	0127-21	0127-41	1	0039-04
RS40C1(E)-IAV*	0061-12	0008-64			0168-02	0088-03			0329-11	0329-11	1	0039-04
RS40C2(E)-IAA*	0061-17	0008-71			0168-10	0088-00	0166-21	0001-62	0127-41	0127-41	1	0039-04
RS40C2(E)-IAV*	0061-12	0008-64			0168-02	0088-03			0329-11	0329-11	1	0039-04
RS40C2-IAA*	0061-17	0008-71					0166-21	0001-62	0127-41	0127-41	1	0039-04
RS40C2-IAV*	0061-12	0008-64			0168-02	0088-03			0329-11	0329-11	1	0039-04
RS43C1(E)-CAA*	0061-06	0008-57	0064-02	0037-06			0166-21	0001-62	0329-15	0329-15	1	0039-04
RS43C1(E)-CAV*	0061-12	0008-64	0064-00	0037-04			0166-14	0001-54	0329-10	0329-10	1	0039-04
RS43C1(E)-IAA*	0061-06	0008-57					0166-21	0001-62	0329-15	0329-15	1	0039-04
RS43C2(E)-CAA*	0061-06	0008-57	0064-02	0037-06			0166-21	0001-62	0329-15	0329-15	1	0039-04
RS43C2(E)-CAV*	0061-12	0008-64	0064-00	0037-04			0166-14	0001-54	0329-10	0329-10	1	0039-04
RS43C2(E)-IAA*	0061-06	0008-57					0166-21	0001-62	0329-15	0329-15	1	0039-04
RS43C2(E)-IAV*	0061-12	0008-64			0168-02	0088-03			0329-11	0329-11	1	0039-04
RS43CC1(E)-IAV*	0061-12	0008-64			0168-02	0088-03			0329-11	0329-11	1	0039-04
RS47C2-IAA*	0061-22	0008-79			0168-13	0088-04			0127-30	0127-30	1	0039-04
RS47C2-IAV*	0061-14	0008-66			0168-01	0088-02	0166-14	0001-54	0370-29	0127-29	1	0039-04
RS54C1(E)-IAA*	0061-22	0008-79			0168-03	0088-04	0166-21	0001-62	0166-06	0127-06	1	0039-04
RS54C1(E)-IAV*	0061-13	0008-72			0168-01	0088-02	0166-19	0001-60	0329-04	0127-04	1	0039-04
RS54C2(E)-IAA*	0061-22	0008-79			0168-03	0088-04	0166-21	0001-62	0127-06	0127-06	1	0039-04
RS54C2(E)-IAV*	0061-13	0008-72			0168-01	0088-02	0166-19	0001-60	0329-04	0127-04	1	0039-04
RS55C1(E)-PAA*	0058-06	0008-48	0064-05	0037-09			0166-19	0001-60	0127-40	0127-40	1	0039-04
RS55C1(E)-PAV*	0061-18	0008-72	0064-02	0037-06			0166-14	0001-54	0329-30	0127-30	1	0039-04
RS55C2(E)-CAA*	0006-13	0008-72	0064-05	0037-09			0166-19	0001-60	0518-02	0127-02	1	0039-04
RS55C2(E)-CAV*	0006-17	0008-71	0064-05	0037-09			0166-14	0001-54	0527-08	0127-08	1	0039-04
RS64C1(E)-CAA*	0061-20	0008-74	0064-12	0037-16			0166-02	0140-03	0127-43	0127-43	1	0039-04
RS64C1(E)-CAV*	0061-09	0008-61	0064-02	0037-06			0166-14	0001-54	0329-16	0127-16	1	0039-04
RS64C1(E)-IAA*	0061-14	0008-66	0064-12	0037-16			0166-19	0001-60	0127-44	0127-44	1	0039-04
RS64C1(E)-IAV*	0061-14	0008-66			0168-00	0088-00	0166-22	N/A	0127-37	0127-37	1	0039-04
RS64C1(E)-PAA*	0061-20	0008-74	0064-12	0037-16			0166-02	0140-03	0127-43	0127-43	1	0039-04
RS64C2(E)-CAA*	0061-20	0008-74	0064-12	0037-16			0166-02	0140-03	0127-43	0127-43	1	0039-04
RS64C2(E)-CAV*	0061-09	0008-61	0064-02	0037-06			0166-14	0001-54	0527-01	0127-01	1	0039-04
RS64C2(E)-IAA*	0061-14	0008-66	0064-12	0037-16			0166-19	0001-60	0127-44	0127-44	1	0039-04
RS64C2(E)-IAV*	0061-14	0008-66	0064-12	0037-16	0168-00	0088-00	0166-02	0140-03	0127-37	0127-37	1	0039-04
RS64C2(E)-PAA*	0061-20	0008-74	0064-12	0037-16			0166-02	0140-03	0127-43	0127-43	1	0039-04
RS64C2-CAV*	0061-09	0008-61	0064-02	0037-06			0166-14	0001-54	0329-16	0329-16	1	0039-04
RS70C1(E)-PFV*	0061-14	0008-66	0064-05	0037-09			0166-19	0001-60	IP		1	0039-04
RS70C1(E)-TFC*									IP		1	0039-04
RS70C1-PAA*	0061-13	0008-72	0064-06	0037-10			0166-19	0001-60	0127-18	0127-18	1	0039-04
RS70C1-PFJ*	0061-13	0008-72	0064-05	0037-09			0166-19	0001-60	IP		1	0039-04
RS70C1-PFV*	0061-14	0008-66	0064-05	0037-09			0166-19	0001-60	IP		1	0039-04

RS - Compressor Parts

Model	Start Capacitor		Run Capacitor		Current Relay		Potential Relay		Protector		Crankcase Heater	MTG Parts (527-)
	OEM	Service	OEM	Service	OEM	Service	OEM	Service	OEM	Service		
	(014-)	(914-)	(014-)	(914-)	(040-)	(940-)	(040-)	(940-)	(071-)	(971-)		
RS70C1-TFC*									IP		1	0039-04
RS70C1-TFD*									IP		1	0039-04
RS80C1(E)-CAV*	0006-13	0008-72	0064-10	0037-14			0166-14	0001-54	0127-37	0127-37	1	0039-04
RS80C1(E)-TF5*									IP		1	0039-04
RS80C2(E)-CAA*	0061-27	0036-03	0064-05	0037-09			0166-19	0001-60	0127-37	0127-37	1	0039-04
RS80C2(E)-CAV*	0006-13	0008-72	0064-10	0037-14			0166-14	0001-54	0127-37	0127-37	1	0039-04
RS80C2(E)-TF5*									IP		1	0039-04
RS86C2(E)-PFV*	0061-20	0008-74	0064-06	0037-10			0166-19	0001-60	IP		1	0039-04
RS97C1(E)-CAA*	0061-04	0008-51	0064-07	0037-11			0166-18	0001-59	0127-45	0127-45	1	0039-04
RS97C1(E)-CAV*	0061-25	0008-74	0064-11	0037-15			0166-14	0001-54	0127-24	0127-24	1	0039-04
RS97C1(E)-TFC*									IP		1	0039-04
RS97C2(E)-CAA*	0061-04	0008-51	0064-07	0037-11			0166-18	0001-59	0127-45	0127-45	1	0039-04
RS97C2(E)-CAV*	0061-25	0008-74	0064-11	0037-15			0166-14	0001-54	0127-24	0127-24	1	0039-04
RS97C2(E)-TFC*									IP		1	0039-04
RSE4-0075-IAA*	0061-22	0008-79			0168-03	0088-04	0166-38	0001-80	0127-30	0127-30	1	0039-04
RSE4-0075-IAV*	0061-14	0008-66			0168-01	0088-02	0166-14	0001-54	0370-29	0127-29	1	0039-04
RSE4-0075-IAZ*	0061-18	0008-72			0168-02	0088-03			0370-33	0127-33	1	0039-04
RSE4-0076-IAA*	0061-22	0008-79			0168-03	0088-04	0166-38	0001-80	0127-30	0127-30	1	0039-04
RSE4-0076-IAV*	0061-14	0008-66			0168-01	0088-02	0166-14	0001-54	0370-29	0127-29	1	0039-04
RSE4-0076-IAZ*	0061-18	0008-72			0168-02	0088-03			0370-33	0127-33	1	0039-04
RSF2-0050-IAA*	0061-17	0008-71					0166-21	0001-62	0127-34	0127-34	1	0039-04
RSF2-0050-IAV*	0058-21	0008-70			0168-02	0088-03	N/A	N/A	0329-10	0329-10	1	0039-04
RSL2-0075-IAA*	0061-22	0008-79			0168-03	0088-04	0166-21	0001-62	0127-06	0329-06	1	0039-04
RSL2-0075-IAV*	0061-18	0008-72			0168-01	0088-02	0166-19	0001-60	0329-04	0329-04	1	0039-04
RSL2-0100-CAA*	0061-21	0008-70	0064-06	0037-10			0166-14	0001-54	0127-30	0127-30	1	0039-04
RSL2-0100-CAV*	0061-25	0008-74	0064-11	0037-15			0166-14	0001-54	0127-24	0127-24	1	0039-04
RSL2-0101-CAA*	0061-21	0008-70	0064-06	0037-10			0166-14	0001-54	0127-30	0127-30	1	0039-04
RSL2-0101-CAV*	0061-25	0008-74	0064-11	0037-15			0166-14	0001-54	0127-24	0127-24	1	0039-04
RSL5-0101-TFC*									IP		1	0039-04
RSN4-0050-IAA*	0061-17	0008-71					0166-21	0001-62	0127-34	0127-34	1	0039-04
RSN4-0050-IAV*	0061-12	0008-64			0168-02	0088-03			0329-11	0329-11	1	0039-04
RSN4-0075-IAA*	0061-22	0008-79			0168-03	0088-04	0166-38		0127-30	0127-30	1	0039-04
RSN4-0075-IAV*	0061-09	0008-61			0168-04	0088-05	0166-13		0127-05	0127-05	1	0039-04
RSN4-0075-PAA*	0061-01	0008-48	0064-05	0037-09			0166-19	0001-60	0127-19	0127-19	1	0039-04
RSN4-0100-CAV*	0061-09	0008-61	0064-02	0037-06			0166-14	0001-54	0329-16	0329-16	1	0039-04
RSN5-0075-IAA*	0061-22	0008-79					0166-38		0127-30	0127-30	1	0039-04
RSN5-0075-IAV*	0061-09	0008-61					0166-13		0127-05	0329-05	1	0039-04
RSN6-0075-IAA*	0061-22	0008-79			0168-03	0088-04	0166-38		0127-30	0127-30	1	0039-04
RSN6-0075-IAV*	0061-09	0008-61			0168-04	0088-05	0166-13		0127-05	0329-05	1	0039-04
RST10K1E-PFV*	0061-29	0036-05	0064-12	0037-16			0166-14	0001-54	IP		2	C001-00

R – Hermetic Compressors

RS - Compressor Parts

Model	Start Capacitor		Run Capacitor		Current Relay		Potential Relay		Protector		Crankcase Heater	MTG Parts (527-)
	OEM	Service	OEM	Service	OEM	Service	OEM	Service	OEM	Service		
	(014-)	(914-)	(014-)	(914-)	(040-)	(940-)	(040-)	(940-)	(071-)	(971-)		
RST10K1E-TA5*											2	C001-00
RST40C1(E)-IAA*	0059-20	N/A			0150-37	N/A			0561-56	0561-56	2	C001-00
RST40C1(E)-IAV*	0053-30	0053-14			0163-15	0150-31			0561-65	0561-65	2	C001-00
RST40C1E-CAA*	0061-32	0036-09	0064-13	0037-17			0166-03	0140-04	0561-48	0561-48	2	C001-00
RST40C1E-CAV*	0061-27	0036-03	0064-33	0037-50			0166-18	0001-59	0561-23	0554-19	2	C001-00
RST45C1(E)-CAA*	0061-32	0036-09	0064-13	0037-17			0166-21	0001-62	0604-10	0604-10	2	C001-00
RST45C1(E)-CAV*	0061-20	0008-74	0064-09	0037-13			0166-27	0001-68	0561-28	0554-42	2	C001-00
RST45C1(E)-IAA*	0061-32	0036-09			0172-03	C016-03			0605-09	0605-09	2	C001-00
RST45C1(E)-IAV*	0053-27	0053-11			0150-36	0150-36			0561-16	0554-22	2	C001-00
RST55C1(E)-CAA*	0061-32	0036-09	0064-13	0037-17			0166-21	0001-62	0605-05	C100-71	2	C001-00
RST55C1(E)-CAV*	0061-27	0036-03	0064-09	0037-13			0166-27	0001-68	0561-02	0554-15	2	C001-00
RST55C1(E)-IAA*	0061-23	0058-41			0172-03	C016-03			0605-08	0605-08	2	C001-00
RST55C1(E)-IAV*	0053-30	0053-14			0150-45	N/A			0561-72	0561-72	2	C001-00
RST61C1E-CAV*	0061-20	0008-74	0064-33	0037-50			0166-13	0001-53	0561-75	N/A	2	C001-00
RST61C1E-CFA*	0061-34	0058-43	0064-14	0037-18			0166-37	0001-79	IP		2	C001-00
RST64C1E-CAV*	0061-20	0008-74	0064-10	0037-14			0166-30	0001-71	0604-13	0604-13	2	C001-00
RST64C1E-CFA*	0058-43	N/A	0064-14	0037-18			0166-37	0001-79	IP		2	C001-00
RST64C1E-IAV*	0061-27	0036-03			0168-04	0172-05			0604-14	0604-14	2	C001-00
RST64C1E-IAZ*	0061-26	0036-02			0168-04	0172-05			0604-12		2	C001-00
RST70C1(E)-PFV*	0061-29	0036-05	0064-11	0037-15			0166-27	0001-68	IP		2	C001-00
RST70C1(E)-TA*									0604-19	0604-19	2	C001-00
RST80C1(E)-PFV*	0061-29	0036-05	0064-12	0037-16			0166-27	0001-68	IP		2	C001-00
RST80C1E-PFA*	0006-18	0036-16	0064-38	0037-54			0046-26	0046-26	IP		2	C001-00
RST80C1E-PFZ*	0061-27	0036-03	0064-12	0037-16			0166-36	0001-78	IP		2	C001-00
RST80C1E-TA5									0604-19	0604-19	2	C001-00
RST97C1(E)-PFV*	0061-29	0036-05	0064-12	0037-16			0166-27	0001-68	IP		2	C001-00
RST97C1E-PFZ*	0061-27	0036-03	0064-12	0037-16			0166-36	0001-78	IP		2	C001-00
RST97C1E-TA5									0604-19	0604-19	2	C001-00
RSU4-0050-IAA*	0061-15	0008-69			0168-03	0088-04	0166-11	N/A	0329-15	0329-15	1	0039-04
RSU5-0050-IAA*	0061-05	0008-69			0168-03	0088-04	0166-11	N/A	0329-15	0329-15	1	0039-04
RSU5-0050-IAV*	0061-12	0008-64			0168-02	0088-03			0329-11	0329-11	1	0039-04



RST

Semi-Hermetic Compressors – E

Code Description	
Code	Description
A	(Air-cooled) - Std. air cooled
R	(Refrigerant-cooled) - Std. refrig. cooled
W	(Water-cooled) - Std. water cooled

Compressor Motor Types		
Phase	Description	Code
1	Capacitor run - Capacitor start	C
1	Induction run - Capacitor start	I
3	Three phase	T
3	Wye (star) delta	E
3	6 lead part winding or across the line - except 575V	F

Product Variations
 Number will be assigned as follows:
 1. Number - 100 is standard compressor used in Copeland brand Condensing units.
 2. Number - 200 indicates a STANDARD Compressor Parts B/M and Model No.
 3. Number - 201 and larger will be assigned for all other variations of a given model.
 4. Number - 800 indicates a standard replacement Compressor and Component Parts B/M and Model No. - 240 volt control.
 5. Number - 801 Indicates a standard replacement Compressor and Component Parts B/M and Model No. - 120 volt control.

Model Variation
 A number or letter, assigned to indicate different model types within any one family series.

E A V B - 0210 - C A V - 201

Compressor Family Series
 Either a number or a letter established for each product model.

Displacement
 A letter only, arbitrarily assigned for each different displacement within any one family series.

Compressor Motor Rating					
Nominal (HP)	Code	Nominal (HP)	Code	Nominal (HP)	Code
1/8	0033	2	0200	5	0500
1/4	0050	2	0210	20	2000
1/2	0051	3	0300	25	2500
3/4	0075	3	0310	30	3000
1	0100	3	0311	35	3500
1 1/2	0150	4	0400	40	4000

Electrical Code		
60 Hz	50 Hz	Code
115-1	-	A
230-1	-	B
208/230-3	200/220-3	C
460-3	380/420-3	D
575-3	550-3	E
208/230/460-3	200/380/400-3	K
-	210/240/380/420-3	L
-	380/420-3	M
230/460-3	200/400-3	N
200-3	-	U
208/230-1	200/220-1	V
-	220/240-1	Z
200/220/380-3	200/380-3	8

Compressor Motor Protection	
Description	Code
External Inherent Protection - One Protector (Line Break) Use with Contactor	A
Internal Inherent Protection - One Protector (Line Break) Use with Contactor	F
Internal Thermal Protection - Electronic Sensors and Control Module External Use with Contactor	S

Common Replacement Parts

Common Parts	Part Number
Terminal Insulator Assembly	521-0067-01
Terminal Fusite for 3 Phase	521-0017-00
Terminal Fusite Seal	020-0844-02
Discharge Valve Kit	998-0510-22
Discharge Valve Gasket	020-0012-10
Suction Valve Kit	998-0510-12
Suction Valve Gasket	020-0012-11
Sight Glass Kit	998-0002-04
Suction Strainer Screen	013-0010-00
Spacer Mounting Assembly	527-0006-00
Gaskets	Part Number
Cylinder Head	020-0122-00
Housing Cover	020-1221-00
Bottom Plate	020-0124-00
Stator Cover	020-0054-00
Crankcase Heater	Part Number
Bolt On 120 Volt 65 Watt	918-0009-00
Bolt On 240 Volt 65 Watt	918-0009-01

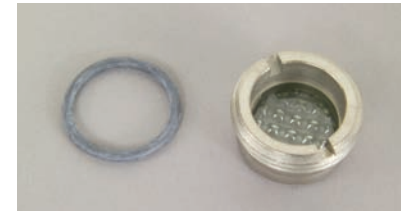
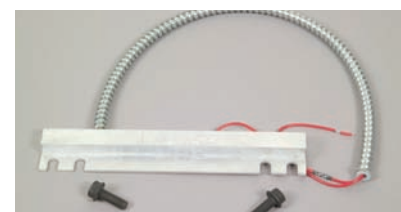

E – Semi-Hermetic Compressors

EA - Compressor Parts (air cooled)

Model	Valve Plate Kit	Complete Gasket Kit	Valve Plate Gasket	Start Capacitor		Run Capacitor		Relay		Protector	Terminal Board Assembly
	(998-)	(998-)	(020-)	OEM	Service	OEM	Service	OEM	Service		
	(998-)	(998-)	(020-)	(014-)	(914-)	(014-)	(914-)	(040-)	(940-)		
EAA1-0150-TAC	0661-14	0669-31	0123-03							0090-03	0052-02
EAA1-0150-TAD	0661-14	0669-31	0123-03							0090-12	0052-00
EAA2-0150-CAB	0661-14	0669-31	0123-03	0061-29	0036-05	0064-10	0037-14	0166-20	0001-61	0092-18	0051-00
EAA2-0150-CAH	0661-14	0669-31	0123-03	0061-29	0036-05	0064-10	0037-14	0166-30	0001-71	0092-18	0051-00
EAB1-0150-TAC	0661-06	0669-30	0123-02							0090-03	0052-02
EAB1-0150-TAD	0661-06	0669-30	0123-02							0090-12	0052-00
EAB1-0200-TAC	0661-06	0669-30	0123-02							0090-00	0052-02
EAB1-0200-TAD	0661-06	0669-30	0123-02							0090-08	0052-02
EAB2-0150-CAB	0661-06	0669-30	0123-02	0061-29	0036-05	0064-10	0037-14	0166-20	0001-61	0092-16	0051-00
EAB2-0150-CAH	0661-06	0669-30	0123-02	0061-29	0036-05	0064-10	0037-14	0166-30	0001-71	0092-16	0051-00
EAB2-0200-CAB	0661-06	0669-30	0123-02	0061-30	0006-01	0064-11	0037-15	0166-20	0001-61	0092-18	0052-02
EABA-0200-TAC	0661-06	0669-30	0123-02							0090-00	0052-02
EABA-0200-TAD	0661-06	0669-30	0123-02							0090-08	0052-02
EABB-0200-CAB	0661-06	0669-30	0123-02	0061-30	0006-01	0064-11	0037-15	0166-20	0001-61	0092-18	0051-00
EAC1-0150-TAC	0661-06	0669-31	0123-03							0090-03	0052-02
EAC1-0150-TAD	0661-06	0669-31	0123-03							0090-12	0052-00
EAC1-0200-TAC	0661-06	0669-31	0123-03							0090-00	0052-02
EAC1-0200-TAD	0661-06	0669-31	0123-03							0090-08	0052-02
EAC2-0150-CAB	0661-06	0669-31	0123-03	0061-29	0036-05	0064-10	0037-14	0166-20	0001-61	0092-16	0051-00
EAC2-0150-CAH	0661-06	0669-31	0123-03	0061-29	0036-05	0064-10	0037-14	0166-30	0001-71	0092-16	0051-00
EAC2-0200-CAB	0661-06	0669-31	0123-03	0061-30	0006-01	0064-11	0037-15	0166-20	0001-61	0092-18	0051-00
EAC2-0200-CAH	0661-06	0669-31	0123-03	0061-30	0006-01	0064-11	0037-15	0166-20	0001-61	0092-18	0051-00
EAC1-0200-TAC	0661-06	0669-31	0123-03							0090-00	0052-02
EACA-0200-TAD	0661-06	0669-31	0123-03							0090-08	0052-02
EACB-0200-CAB	0661-06	0669-31	0123-03	0061-30	0006-01	0064-11	0037-15	0166-20	0001-61	0092-18	0051-00
EACB-0200-CAH	0661-06	0669-31	0123-03	0061-30	0006-01	0064-11	0037-15	0166-20	0001-61	0092-18	0051-00
EAD1-0200-TAC	0661-14	0669-30	0123-02							0090-00	0052-02
EAD1-0200-TAD	0661-14	0669-30	0123-02							0090-08	0052-02
EAD1-0320-TAC	0661-14	0669-30	0123-02							0090-38	0052-02
EAD1-0320-TAD	0661-14	0669-30	0123-02							0090-03	0052-02
EAD2-0200-CAB	0661-14	0669-30	0123-02	0061-30	0006-01	0064-11	0037-15	0166-20	0001-61	0092-18	0051-00
EAD2-0200-CAH	0661-14	0669-30	0123-02	0061-30	0006-01	0064-11	0037-15	0166-20	0001-61	0092-18	0051-00
EAD2-0320-CAB	0661-14	0669-30	0123-02	0006-13	0006-03	0064-14	0037-18	0166-28	0001-69	0119-06	0050-00
EADA-0200-TAC	0661-14	0669-30	0123-02							0090-00	0052-02
EADA-0200-TAD	0661-14	0669-30	0123-02							0090-15	0052-00
EADA-020E-TAC	0661-14	0669-30	0123-02							0090-00	0052-02
EADB-0200-CAB	0661-14	0669-30	0123-20	0061-30	0006-01	0064-11	0037-15	0166-20	0001-61	0092-18	0051-00
EADB-021E-CAB	0661-14	0669-30	0123-02	0061-30	0006-01	0064-11	0037-15	0166-20	0001-61	0099-03	0051-00
EAJ2-0150-CAB	0661-14	0669-28	0123-06	0061-29	0036-05	0064-10	0037-14	0166-20	0001-61	0092-16	0051-00
EAJ2-0150-CAH	0661-14	0669-28	0123-06	0061-29	0036-05	0064-10	0037-14	0166-30	0001-71	0092-16	0051-00

Note: EW water cooled compressors are the same as the EA model having body fin casting except for a factory installed water jacket.

EA - Compressor Parts (air cooled)

Model	Valve Plate Kit	Complete Gasket Kit	Valve Plate Gasket	Start Capacitor		Run Capacitor		Relay		Protector	Terminal Board Assembly
	(998-)	(998-)	(020-)	OEM	Service	OEM	Service	OEM	Service		
	(014-)	(914-)	(014-)	(914-)	(040-)	(940-)	(071-)	(580-)			
EAJA-0150-TAC	0661-14	0669-28	0123-06							0090-03	0052-02
EAJA-0150-TAD	0661-14	0669-28	0123-06							0090-12	0052-00
EAL1-0200-TAC	0661-06	0669-28	0123-00							0090-00	0052-02
EAL1-0200-TAD	0661-06	0669-28	0123-00							0090-08	0052-02
EAL2-0200-CAB	0661-06	0669-28	0123-00	0061-30	0006-01	0064-11	0037-15	0166-20	0001-61	0092-18	0051-00
EAL2-0200-CAH	0661-06	0669-28	0123-00	0061-30	0006-01	0064-11	0037-15	0166-20	0001-61	0098-18	0051-00
EAV1-0150-TAC	0661-06	0669-28	0123-00							0090-03	0052-02
EAV1-0150-TAD	0661-06	0669-28	0123-00							0090-12	0052-00
EAV1-0200-TAC	0661-06	0669-28	0123-00							0090-00	0052-02
EAV1-0200-TAD	0661-06	0669-28	0123-00							0090-08	0052-02
EAV2-0150-CAB	0661-06	0669-28	0123-00	0061-29	0036-05	0064-10	0037-14	0166-20	0001-61	0092-16	0051-00
EAV2-0150-CAH	0661-06	0669-28	0123-00	0061-29	0036-05	0064-10	0037-14	0166-30	0001-71	0092-16	0051-00
EAV2-0200-CAB	0661-06	0669-28	0123-00	0061-30	0006-01	0064-11	0037-15	0166-20	0001-61	0099-01	0051-00
EAV2-0200-CAH	0661-06	0669-28	0123-00	0061-30	0006-01	0064-11	0037-15	0166-20	0001-61	0099-02	0051-00
EAVA-0210-TAC	0661-06	0669-28	0123-00							0090-35	0052-02
EAVA-0210-TAD	0661-06	0669-28	0123-00							0090-13	0052-02
EAVA-021E-TAC	0661-06	0669-28	0123-00							0090-35	0052-02
EAVA-021E-TAD	0661-06	0669-28	0123-00							0090-13	0052-02
EAVB-0210-CAV	0661-06	0669-28	0123-00	0006-13	0006-03	0064-14	0037-18	0166-28	0001-69	0119-05	0050-00
EAVB-021E-CAV	0661-06	0669-28	0123-00	0006-13	0006-03	0064-14	0037-18	0166-28	0001-69	0119-05	0050-00

Note: EW water cooled compressors are the same as the EA model having body fin casting except for a factory installed water jacket.

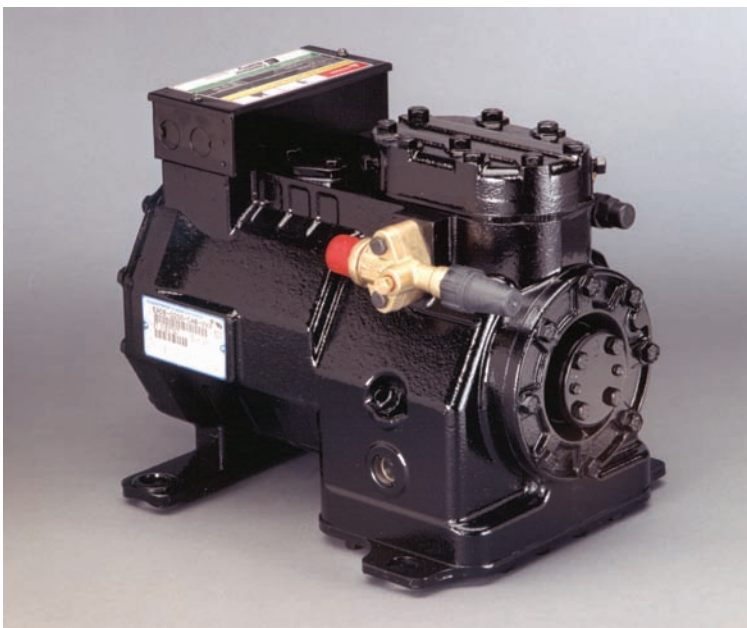

E – Semi-Hermetic Compressors

ER - Compressor Parts (air cooled)

Model	Valve Plate Kit	Complete Gasket Kit	Valve Plate Gasket	Start Capacitor		Run Capacitor		Relay		Protector	Terminal Board Assembly
	(998-)	(998-)	(020-)	OEM	Service	OEM	Service	OEM	Service		
	(998-)	(998-)	(020-)	(014-)	(914-)	(014-)	(914-)	(040-)	(940-)		
ERA1-0200-TAC	0661-06	0669-31	0123-03							0090-00	0052-02
ERA1-0200-TAD	0661-06	0669-31	0123-03							0090-08	0052-02
ERA2-0200-CAB	0661-06	0669-31	0123-03	0061-30	0036-07	0064-11	0037-15	0166-20	0001-61	0103-02	0051-00
ERC1-0200-TAC	0661-06	0669-31	0123-03							0090-00	0052-02
ERC1-0200-TAD	0661-06	0669-31	0123-03							0090-08	0052-02
ERC2-0200-CAB	0661-06	0669-31	0123-03	0061-30	0036-07	0064-11	0037-15	0166-20	0001-61	0099-01	0051-00
ERCA-020E-TAD	0661-06	0669-31	0123-03							0090-08	0052-02
ERCA-021E-TAC	0661-06	0669-31	0123-03							0090-49	0052-02
ERF1-0310-TAC	0661-06	0669-30	0123-02							0090-02	0052-01
ERF1-0310-TAD	0661-06	0669-30	0123-02							0090-10	0052-02
ERF1-0311-TAC	0661-06	0669-30	0123-02							0090-36	0052-01
ERF1-0311-TAD	0661-06	0669-30	0123-02							0090-10	0052-02
ERF2-0310-CAB	0661-06	0669-30	0123-02	0061-30	0036-07	0064-14	0037-18	0166-28	0001-69	0119-00	0050-00
ERFA-0311-TAD	0661-06	0669-30	0123-02							0090-10	0052-02
ERFA-031E-TAC	0661-06	0669-30	0123-02							0090-36	0052-01
ERFA-031E-TAD	0661-06	0669-30	0123-02							0090-10	0052-02
ERFB-031E-CAB	0661-06	0669-30	0123-02	0061-30	0036-07	0064-14	0037-18	0166-28	0001-69	0119-00	0050-00
ERJ1-0200-TAC	0661-18	0669-28	0123-04							0090-00	0052-02
ERJ1-0200-TAD	0661-18	0669-27	0123-04							0090-08	0052-02
ERJ2-0200-CAB	0661-18	0669-27	0123-04	0061-30	0036-07	0064-11	0037-15	0166-20	0001-61	0103-02	0051-00
ERJ2-0200-CAH	0661-18	0669-27	0123-04	0061-30	0036-07	0064-11	0037-15	0166-20	0001-61	0099-02	0051-00

Note: EW water cooled compressors are the same as the EA model having body fin casting except for a factory installed water jacket.



Semi-Hermetic Compressors – H

Code Description	
Code	Description
A	(Air-cooled) - Std. air cooled
R	(Refrigerant-cooled) - Std. refrig. cooled
W	(Water-cooled) - Std. water cooled

Compressor Motor Types		
Phase	Description	Code
1	Capacitor run - Capacitor start	C
1	Induction run - Capacitor start	I
3	Three phase	T
3	Wye (star) delta	E
3	6 lead part winding or across the line - except 575V	F

Product Variations
 Number will be assigned as follows:
 1. Number - 100 is standard compressor used in Copeland brand Condensing units.
 2. Number - 200 indicates a STANDARD Compressor Parts B/M and Model No.
 3. Number - 201 and larger will be assigned for all other variations of a given model.
 4. Number - 800 indicates a standard replacement Compressor and Component Parts B/M and Model No. - 240 volt control.
 5. Number - 801 Indicates a standard replacement Compressor and Component Parts B/M and Model No. - 120 volt control.

Model Variation
 A number or letter, assigned to indicate different model types within any one family series.

H A T B - 0051 - C A V - 201

Compressor Family Series
 Either a number or a letter established for each product model.

Displacement
 A letter only, arbitrarily assigned for each different displacement within any one family series.

Compressor Motor Rating					
Nominal (HP)	Code	Nominal (HP)	Code	Nominal (HP)	Code
1/3	0033	2	0200	5	0500
1/2	0050	2	0210	20	2000
1/2	0051	3	0300	25	2500
3/4	0075	3	0310	30	3000
1	0100	3	0311	35	3500
1 1/2	0150	4	0400	40	4000

Electrical Code		
60 Hz	50 Hz	Code
115-1	-	A
230-1	-	B
208/230-3	200/220-3	C
460-3	380/420-3	D
575-3	550-3	E
208/230/460-3	200/380/400-3	K
-	210/240/380/420-3	L
-	380/420-3	M
230/460-3	200/400-3	N
200-3	-	U
208/230-1	200/220-1	V
-	220/240-1	Z
200/220/380-3	200/380-3	8

Compressor Motor Protection		
Description	Code	
External Inherent Protection - One Protector (Line Break) Use with Contactor	A	
Internal Inherent Protection - One Protector (Line Break) Use with Contactor	F	
Internal Thermal Protection - Electronic Sensors and Control Module External Use with Contactor	S	

Common Replacement Parts

Common Parts	Part Number
Suction Screen	013-0146-00
Mounting Assembly	527-0005-01
Terminal Board	580-0070-00
Gaskets	Part Number
Cylinder Head	020-0071-00
Stator Cover	020-0096-02
Housing Cover	020-0107-02
Bottom Plate	020-0003-09
Crankcase Heater	Part Number
Bolt On 120 Volt 50 Watt	918-0118-05
Bolt On 240 Volt 50 Watt	918-0118-06



H – Semi-Hermetic Compressors

HA - Compressor Parts (refrigerant cooled)

Model	Valve Plate Kit	Complete Gasket Kit	Valve Plate Gasket	Start Capacitor		Run Capacitor		Relay		Protector	Terminal Board Assembly
				OEM	Service	OEM	Service	OEM	Service		
	(998-)	(998-)	(020-)	(014-)	(914-)	(014-)	(914-)	(040-)	(940-)		
HAF2-0025-IAA	0661-12	0669-05	0095-03	0061-06	0008-57			0115-00	0115-00	0092-37	0003-00
HAF2-0025-IAB	0661-12	0669-05	0095-03	0061-13	0008-65			0115-01	0115-01	0092-32	0003-00
HAF2-0025-SAA	0661-12	0669-05	0095-03					0115-00	0115-00	0092-37	0003-00
HAF2-0033-IAA	0661-12	0669-05	0095-03	0061-07	0008-58			0166-08	0001-48	0092-04	0003-00
HAF2-0033-IAB	0661-12	0669-05	0095-03	0061-12	0008-64			0166-19	0001-60	0092-31	0003-00
HAFB-0033-IAA	0661-12	0669-05	0095-03	0061-07	0008-58			0166-08	0001-48	0092-04	0003-00
HAFB-003E-IAA	0661-12	0669-05	0095-03	0061-07	0008-58			0166-08	0001-48	0092-04	0003-00
HAG1-0050-TAC	0661-12	0669-05	0095-03							0090-42	0003-00
HAG2-0050-CAA	0661-12	0669-05	0095-03	0061-02	0008-49	0064-00	0037-04	0166-33	0001-75	0099-03	0003-00
HAG2-0050-CAV	0661-12	0669-05	0095-03	0061-29	0036-05	0064-00	0037-04	0166-09	0001-49	0092-27	0003-00
HAJ1-0050-TAC	0661-12	0669-06	0095-02							0090-42	0003-00
HAJ2-0025-IAA	0661-12	0669-06	0095-02	0061-06	0008-57			0115-00	0115-00	0092-37	0003-00
HAJ2-0025-IAB	0661-12	0669-06	0095-02	0061-13	0008-65			0115-01	0115-01	0092-32	0003-00
HAJ2-0025-SAA	0661-12	0669-06	0095-02					0115-00	0115-00	0092-37	0003-00
HAJ2-0033-IAA	0661-12	0669-06	0095-02	0061-07	0008-58			0166-08	0001-48	0092-04	0003-00
HAJ2-0033-IAB	0661-12	0669-06	0095-02	0061-12	0008-64			0166-19	0001-60	0092-31	0003-00
HAJ2-0050-CAA	0661-12	0669-06	0095-02	0061-02	0008-49	0064-00	0037-04	0166-33	0001-75	0099-03	0003-00
HAJ2-0050-CAV	0661-12	0669-06	0095-02	0061-29	0036-05	0064-00	0037-04	0166-09	0001-49	0092-27	0003-00
HAJ2-0050-IAA	0661-12	0669-06	0095-02	0061-02	0008-49			0166-08	0001-48	0092-35	0003-00
HAJB-003E-IAA	0661-12	0669-06	0095-02	0061-07	0008-58			0166-08	0001-48	0092-04	0003-00
HAJB-005E-CAV	0661-12	0669-06	0095-02	0061-29	0036-05	0064-00	0037-04	0166-25	0001-49	0092-27	0003-00
HAK2-0033-IAA	0661-12	0669-07	0097-00	0061-07	0008-58			0166-08	0001-48	0092-04	0003-00
HAK2-0033-IAB	0661-12	0669-07	0097-00	0061-12	0008-64			0166-19	0001-60	0092-31	0003-00
HAK2-0050-IAA	0661-12	0669-07	0097-00	0061-02	0008-49			0166-08	0001-48	0092-35	0003-00
HAK2-0050-IAB	0661-12	0669-07	0097-00	0061-09	0008-61			0166-09	0001-49	0092-05	0003-00
HAT2-0033-IAA	0661-12	0669-07	0097-00	0061-07	0008-58			0166-08	0001-48	0092-04	0003-00
HAT2-0033-IAB	0661-12	0669-07	0097-00	0061-12	0008-64			0166-19	0001-60	0092-31	0003-00
HAT2-0050-IAA	0661-12	0669-07	0097-00	0061-02	0008-49			0166-08	0001-48	0092-35	0003-00
HAT2-0050-IAB	0661-12	0669-07	0097-00	0061-09	0008-61			0166-09	0001-49	0092-05	0003-00
HATB-0051-CAA	0661-12	0669-07	0097-00	0061-02	0008-49	0064-04	0037-08	0166-11	0001-51	0099-03	0003-00
HATB-005E-CAA	0661-12	0669-07	0097-00	0061-02	0008-49	0064-04	0037-08	0166-11	0001-51	0099-03	0003-00

Note: HW water cooled compressors are the same as the HA model having body fin casting except for a factory installed water jacket.

Code Description	
Code	Description
A	(Air-cooled) - Std. air cooled
R	(Refrigerant-cooled) - Std. refrig. cooled
W	(Water-cooled) - Std. water cooled

Compressor Motor Types		
Phase	Description	Code
1	Capacitor run - Capacitor start	C
1	Induction run - Capacitor start	I
3	Three phase	T
3	Wye (star) delta	E
3	6 lead part winding or across the line - except 575V	F

Product Variations
 Number will be assigned as follows:
 1. Number - 100 is standard compressor used in Copeland brand Condensing units.
 2. Number - 200 indicates a STANDARD Compressor Parts B/M and Model No.
 3. Number - 201 and larger will be assigned for all other variations of a given model.
 4. Number - 800 indicates a standard replacement Compressor and Component Parts B/M and Model No. - 240 volt control.
 5. Number - 801 Indicates a standard replacement Compressor and Component Parts B/M and Model No. - 120 volt control.

Model Variation
 A number or letter, assigned to indicate different model types within any one family series.

K A T A - 0100 - C A V - 201

Compressor Family Series
 Either a number or a letter established for each product model.

Displacement
 A letter only, arbitrarily assigned for each different displacement within any one family series.

Compressor Motor Rating					
Nominal (HP)	Code	Nominal (HP)	Code	Nominal (HP)	Code
1/8	0033	2	0200	5	0500
1/4	0050	2	0210	20	2000
1/2	0051	3	0300	25	2500
3/4	0075	3	0310	30	3000
1	0100	3	0311	35	3500
1 1/2	0150	4	0400	40	4000

Electrical Code		
60 Hz	50 Hz	Code
115-1	-	A
230-1	-	B
208/230-3	200/220-3	C
460-3	380/420-3	D
575-3	550-3	E
208/230/460-3	200/380/400-3	K
-	210/240/380/420-3	L
-	380/420-3	M
230/460-3	200/400-3	N
200-3	-	U
208/230-1	200/220-1	V
-	220/240-1	Z
200/220/380-3	200/380-3	8

Compressor Motor Protection		
Description	Code	
External Inherent Protection - One Protector (Line Break) Use with Contactor	A	
Internal Inherent Protection - One Protector (Line Break) Use with Contactor	F	
Internal Thermal Protection - Electronic Sensors and Control Module External Use with Contactor	S	

Common Replacement Parts

Common Parts	Part Number
Sight Glass Kit	998-0002-04
Suction Strainer Screen	013-0146-00
Terminal Board - All K models	580-0070-00
Three Phase Only	
Terminal Fused Cluster (Fusite)	521-0016-00
Terminal Fused Seal (Fusite)	020-0844-02
Without Oil Pump	
Spring Mounting Parts Kit - All 1/2 hp to 1 hp models	527-0005-02
Spring Mounting Parts Kit - All 1 1/2 hp to 2 hp models	527-0005-03
Gaskets	Part Number
Cylinder Head Gasket	020-0920-01
Stator Cover Gasket	020-0096-02
Housing Cover Gasket	020-0107-02
Bottom Plate Gasket - O-ring	020-0003-09
Crankcase Heater	Part Number
Bolt On 120 Volt 50 Watt	918-0118-05
Bolt On 240 Volt 50 Watt	918-0118-06
Bolt On 480 Volt 50 Watt	918-0118-03

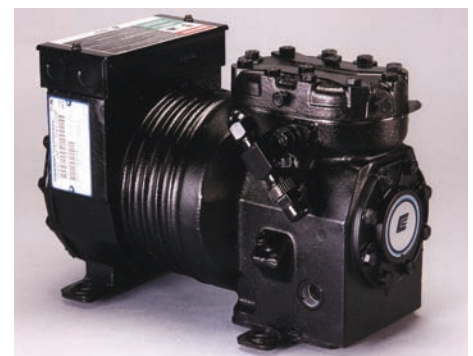

K – Semi-Hermetic Compressors

KA - Compressor Parts (air cooled)

Model	Valve Plate Kit	Complete Gasket Kit	Valve Plate Gasket	Start Capacitor		Run Capacitor		Relay		Protector	Terminal Insulator Assembly
	(998-)	(998-)	(020-)	OEM	Service	OEM	Service	OEM	Service		
	(014-)	(914-)	(014-)	(914-)	(040-)	(940-)	(071-)	(580-)			
KAA1-0075-TAC	0661-16	0669-14	0958-03							0090-05	0003-00
KAA2-0075-CAA	0661-16	0669-14	0958-03	0061-14	0008-66	0064-02	0037-06	0166-11	0001-51	0092-20	0003-00
KAA2-0075-CAV	0661-16	0669-14	0958-03	0061-04	0008-51	0064-00	0037-04	0166-09	0001-49	0092-29	0003-00
KAA2-0075-IAA	0661-16	0669-14	0958-03	0061-11	0008-63			0166-08	0001-48	0099-00	0003-00
KAA2-0075-IAB	0661-16	0669-14	0958-03	0061-04	0008-51			0166-09	0001-49	0092-27	0003-00
KAA2-0075-IAH	0661-16	0669-14	0958-03	0061-04	0008-51			0166-09	0001-49	0092-27	0003-00
KAA2-0076-CAA	0661-16	0669-14	0958-03	0061-11	0008-63	0064-06	0037-10	0166-33	0001-75	0092-38	0003-00
KAAB-0075-IAA	0661-16	0669-14	0958-03	0061-11	0008-63			0166-08	0001-48	0099-00	0003-00
KAAB-007E-CAA	0661-16	0669-14	0958-03	0061-11	0008-63	0064-11	0037-15	0166-08	0001-48	0099-00	0003-00
KAD1-0075-TAC	0661-16	0669-11	0958-01							0090-05	0003-00
KAD2-0075-CAA	0661-16	0669-11	0958-01	0061-11	0008-63	0064-06	0037-10	0166-33	0001-75	0099-07	0003-00
KAD2-0075-CAV	0661-16	0669-11	0958-01	0061-04	0008-51	0064-00	0037-04	0166-09	0001-49	0092-29	0003-00
KAE1-0050-TAC	0661-42	0669-12	0958-02							0090-06	0003-00
KAE1-0075-TAC	0661-42	0669-12	0958-02							0090-41	0003-00
KAE2-0050-CAV	0661-42	0669-12	0958-02	0061-29	0036-05	0064-00	0037-04	0166-09	0001-49	0092-37	0003-00
KAE2-0050-IAA	0661-42	0669-12	0958-02	0061-02	0008-49			0166-08	0001-48	0092-06	0003-00
KAE2-0050-IAB	0661-42	0669-12	0958-02	0061-09	0008-61			0166-09	0001-49	0092-05	0003-00
KAE2-0050-IAH	0661-42	0669-12	0958-02	0061-09	0008-61			0166-09	0001-49	0092-05	0003-00
KAE2-0075-CAA	0661-42	0669-12	0958-02	0061-11	0008-63	0064-06	0037-10	0166-33	0001-75	0099-06	0003-00
KAE2-0075-CAV	0661-42	0669-12	0958-02	0061-04	0008-51	0064-00	0037-04	0166-09	0001-49	0092-29	0003-00
KAEA-007E-TAC	0661-42	0669-12	0958-02							0090-41	0003-00
KAEB-007E-CAA	0661-42	0669-12	0958-02	0061-11	0008-63	0064-06	0037-10	0166-33	0001-75	0099-06	0003-00
KAEB-007E-CAV	0661-42	0669-12	0958-02	0061-04	0008-51	0064-00	0037-04	0166-09	0001-49	0092-29	0003-00
KAG1-0050-TAC	0661-16	0669-11	0958-01							0090-06	0003-00
KAG1-0075-TAC	0661-16	0669-11	0958-01							0090-05	0003-00
KAG1-0100-TAC	0661-16	0669-11	0958-01							0090-16	0003-00
KAG1-0100-TAD	0661-16	0669-11	0958-01							0090-07	0003-00
KAG2-0050-CAV	0661-16	0669-11	0958-01	0061-29	0036-05	0064-00	0037-04	0166-09	0001-49	0092-37	0003-00
KAG2-0050-IAA	0661-16	0669-11	0958-01	0061-02	0008-49			0166-08	0001-48	0092-06	0003-00
KAG2-0050-IAB	0661-16	0669-11	0958-01	0061-09	0008-61			0166-09	0001-49	0092-05	0003-00
KAG2-0050-IAH	0661-16	0669-11	0958-01	0061-09	0008-61			0166-09	0001-49	0092-05	0003-00
KAG2-0075-CAA	0661-16	0669-11	0958-01	0061-14	0008-66	0064-04	0037-06	0166-11	0001-51	0092-20	0003-00
KAG2-0075-CAV	0661-16	0669-11	0958-01	0061-04	0008-51	0064-00	0037-04	0166-09	0001-50	0092-29	0003-00
KAG2-0075-IAA	0661-16	0669-11	0958-01	0061-11	0008-63			0166-08	0001-48	0099-00	0003-00
KAG2-0075-IAB	0661-16	0669-11	0958-01	0061-04	0008-51			0166-09	0001-49	0092-27	0003-00
KAG2-0075-IAH	0661-16	0669-11	0958-01	0061-04	0008-51			0166-09	0001-49	0092-27	0003-00
KAG2-0100-CAA	0661-16	0669-11	0958-01	0061-05	0008-52	0064-08	0037-12	0166-11	0001-51	0092-40	0176-00
KAG2-0100-CAV	0661-16	0669-11	0958-01	0061-04	0008-51	0064-00	0037-04	0166-09	0001-49	0092-39	0176-00
KAGA-0150-TAC	0661-16	0669-11	0958-01							0090-39	0176-00
KAGA-0150-TAD	0661-16	0669-11	0958-01							0090-27	0176-00
KAGB-0050-IAA	0661-16	0669-11	0958-01	0061-02	0008-49			0166-08	0001-48	0092-06	0003-00
KAGB-005E-IAA	0661-16	0669-11	0958-01	0061-02	0008-49			0166-08	0001-48	0092-06	0003-00

Note: KW water cooled compressors are the same as the KA model having body fin casting except for a factory installed water jacket.

KA - Compressor Parts (air cooled)

Model	Valve Plate Kit	Complete Gasket Kit	Valve Plate Gasket	Start Capacitor		Run Capacitor		Relay		Protector	Terminal Insulator Assembly
	(998-)	(998-)	(020-)	OEM	Service	OEM	Service	OEM	Service		
	(014-)	(914-)	(014-)	(914-)	(040-)	(940-)	(071-)	(580-)			
KAGB-0150-CAV	0661-16	0669-11	0958-01	0061-30	0006-01	0064-19	0037-23	0166-20	0001-61	0099-04	0176-00
KAJ1-0075-TAC	0661-16	0669-13	0958-00							0090-05	0003-00
KAJ1-0100-TAC	0661-16	0669-13	0958-00							0090-04	0003-00
KAJ1-0100-TAD	0661-16	0669-13	0958-00							0090-07	0003-00
KAJ3-0075-CAV	0661-16	0669-13	0958-00	0061-04	0008-51	0064-00	0037-04	0166-09	0001-49	0092-29	0003-00
KAJ3-0075-IAA	0661-16	0669-13	0958-00	0061-11	0008-63			0166-08	0001-48	0099-00	0003-00
KAJ3-0075-IAB	0661-16	0669-13	0958-00	0061-04	0008-51			0166-09	0001-49	0092-27	0003-00
KAJ3-0075-IAH	0661-16	0669-13	0958-00	0061-04	0008-51			0166-09	0001-49	0092-27	0003-00
KAJ3-0100-CAA	0661-16	0669-13	0958-00	0061-05	0008-52	0064-08	0037-12	0166-11	0001-51	0092-23	0176-00
KAJ3-0100-CAB	0661-16	0669-13	0958-00	0061-04	0008-51	0064-00	0037-04	0166-10	0001-50	0092-25	0003-00
KAJ3-0100-CAH	0661-16	0669-13	0958-00	0061-04	0008-51	0064-00	0037-04	0166-25	0001-66	0092-14	0003-00
KAJ3-0100-CAV	0661-16	0669-13	0958-00	0061-04	0008-51	0064-10	0037-14	0166-10	0001-50	0092-39	0176-00
KAJA-0100-TAC	0661-16	0669-13	0958-00							0090-04	0003-00
KAJA-0101-TAC	0661-16	0669-13	0958-00							0090-16	0003-00
KAJA-010E-TAC	0661-16	0669-13	0958-00							0090-04	0003-00
KAJA-011E-TAC	0661-16	0669-13	0958-00							0090-50	0003-00
KAJA-011E-TAD	0661-16	0669-13	0958-00							0090-21	0003-00
KAJB-007E-IAA	0661-16	0669-13	0958-00	0061-11	0008-63			0166-08	0001-48	0099-00	0003-00
KAJB-0100-CAA	0661-16	0669-13	0958-00	0061-05	0008-52	0064-08	0037-12	0166-11	0001-51	0092-23	0176-00
KAJB-0100-CAV	0661-16	0669-13	0958-00	0061-04	0008-51	0064-10	0037-14	0166-10	0001-50	0092-39	0176-00
KAJB-010E-CAV	0661-16	0669-13	0958-00	0061-04	0008-51	0064-10	0037-14	0166-10	0001-50	0092-39	0176-00
KAJC-0100-TAC	0661-16	0669-13	0958-00							0090-04	0003-00
KAJC-0101-TAC	0661-16	0669-13	0958-00							0090-16	0003-00
KAK1-0100-TAC	0661-16	0669-14	0958-03							0090-04	0003-00
KAK1-0100-TAD	0661-16	0669-14	0958-03							0090-07	0003-00
KAK2-0100-CAA	0661-16	0669-14	0958-03	0061-05	0008-52	0064-08	0037-12	0166-11	0001-51	0092-23	0176-00
KAK2-0100-CAB	0661-16	0669-14	0958-03	0061-04	0008-51	0064-00	0037-04	0166-10	0001-50	0092-25	0003-00
KAK2-0100-CAH	0661-16	0669-14	0958-03	0061-04	0008-51	0064-00	0037-04	0166-25	0001-66	0092-14	0003-00
KAK2-0100-CAV	0661-16	0669-14	0958-03	0061-04	0008-51	0064-10	0037-14	0166-10	0001-50	0092-39	0176-00
KAKA-0100-TAC	0661-16	0669-14	0958-03							0090-04	0003-00
KAKA-0200-TAC	0661-16	0669-14	0958-03							0090-35	0176-00
KAKA-0200-TAD	0661-16	0669-14	0958-03							0090-16	0176-00
KAKB-011E-CAV	0661-16	0669-14	0958-03	0061-04	0008-51	0064-14	0037-18	0166-10	0001-50	0092-42	0176-00
KAKB-0150-CAB	0661-16	0669-14	0958-03	0061-29	0036-05	0064-11	0037-15	0166-20	0001-61	0092-29	0176-00
KAKB-0151-CAB	0661-16	0669-14	0958-03	0061-29	0036-05	0064-19	0037-23	0166-20	0001-61	0099-03	0176-00
KAKB-0200-CAV	0661-16	0669-14	0958-03	0061-30	0006-01	0064-19	0037-23	0166-20	0001-61	0099-04	0176-00
KAKC-0200-TAC	0661-16	0669-14	0958-03							0090-35	0176-00
KAL1-0100-TAC	0661-16	0669-15	0958-04							0090-04	0003-00
KAL1-0100-TAD	0661-16	0669-15	0958-04							0090-07	0003-00
KAL2-0100-CAA	0661-16	0669-15	0958-04	0061-05	0008-52	0064-08	0037-12	0166-11	0001-51	0092-23	0176-00
KAL2-0100-CAB	0661-16	0669-15	0958-04	0061-04	0008-51	0064-00	0037-04	0166-10	0001-50	0092-25	0003-00
KAL2-0100-CAH	0661-16	0669-15	0958-04	0061-04	0008-51	0064-00	0037-04	0166-25	0001-66	0092-14	0003-00

Note: KW water cooled compressors are the same as the KA model having body fin casting except for a factory installed water jacket.

K – Semi-Hermetic Compressors

KA - Compressor Parts (air cooled)

Model	Valve Plate Kit	Complete Gasket Kit	Valve Plate Gasket	Start Capacitor		Run Capacitor		Relay		Protector	Terminal Insulator Assembly
	(998-)	(998-)	(020-)	OEM	Service	OEM	Service	OEM	Service		
	(014-)	(914-)	(014-)	(914-)	(040-)	(940-)	(071-)	(580-)			
KAL2-0100-CAV	0661-16	0669-15	0958-04	0061-04	0008-51	0064-10	0037-14	0166-10	0001-50	0092-39	0176-00
KALA-0100-TAC	0661-16	0669-15	0958-04							0090-04	0003-00
KALA-0100-TAD	0661-16	0669-15	0958-04							0090-07	0003-00
KALA-0150-TAC	0661-16	0669-15	0958-04							0090-03	0176-00
KALA-0150-TAD	0661-16	0669-15	0958-04							0090-27	0176-00
KALA-016E-TAC	0661-16	0669-15	0958-04							0090-35	0176-00
KALA-016E-TAD	0661-16	0669-15	0958-04							0090-16	0176-00
KALB-0100-CAA	0661-16	0669-15	0958-06	0061-05	0008-52	0064-08	0037-12	0166-11	0001-51	0092-23	0176-00
KALB-0100-CAB	0661-16	0669-15	0958-06	0061-04	0008-51	0064-00	0037-04	0166-10	0001-50	0092-25	0003-00
KALB-0100-CAH	0661-16	0669-15	0958-06	0061-04	0008-51	0064-00	0037-04	0166-25	0001-66	0092-14	0003-00
KALB-0100-CAV	0661-16	0669-15	0958-06	0061-04	0008-51	0064-10	0037-14	0166-10	0001-50	0092-39	0176-00
KALB-010E-CAV	0661-16	0669-15	0958-06	0061-04	0008-51	0064-10	0037-14	0166-10	0001-50	0092-39	0176-00
KALB-0150-CAB	0661-16	0669-15	0958-06	0061-29	0036-05	0064-10	0037-14	0166-20	0001-61	0092-16	0176-00
KALB-0150-CAH	0661-16	0669-15	0958-06	0061-29	0036-05	0064-10	0037-14	0166-30	0001-71	0092-18	0176-00
KALB-0150-CAV	0661-16	0669-15	0958-06	0061-30	0006-01	0064-19	0037-23	0166-20	0001-61	0099-04	0176-00
KALB-0151-CAB	0661-16	0669-15	0958-06	0061-29	0036-05	0064-19	0037-23	0166-20	0001-61	0099-03	0176-00
KALB-015E-CAV	0661-16	0669-15	0958-06	0061-30	0006-01	0064-19	0037-23	0166-20	0001-61	0099-04	0176-00
KAM1-0050-TAC	0661-16	0669-50	0958-05							0090-06	0003-00
KAM1-0075-TAC	0661-16	0669-50	0958-05							0090-05	0003-00
KAM1-0100-TAC	0661-16	0669-50	0958-05							0090-40	0003-00
KAM1-0100-TAD	0661-16	0669-50	0958-05							0090-43	0003-00
KAM2-0050-CAV	0661-16	0669-50	0958-05	0061-29	0036-05	0064-00	0037-04	0166-09	0001-49	0092-37	0003-00
KAM2-0050-IAA	0661-16	0669-50	0958-05	0061-02	0008-49			0166-08	0001-48	0092-06	0003-00
KAM2-0050-IAB	0661-16	0669-50	0958-05	0061-09	0008-61			0166-09	0001-49	0092-05	0003-00
KAM2-0050-IAH	0661-16	0669-50	0958-05	0061-09	0008-61			0166-09	0001-49	0092-05	0003-00
KAM2-0075-CAV	0661-16	0669-50	0958-05	0061-04	0008-51	0064-00	0037-04	0166-09	0001-49	0092-29	0003-00
KAM2-0075-IAA	0661-16	0669-50	0958-05	0061-11	0008-63			0166-08	0001-48	0099-00	0003-00
KAM2-0075-IAB	0661-16	0669-50	0958-05	0061-04	0008-51			0166-09	0001-49	0092-27	0003-00
KAM2-0075-IAH	0661-16	0669-50	0958-05	0061-04	0008-51			0166-09	0001-49	0092-27	0003-00
KAM2-0100-CAA	0661-16	0669-50	0958-05	0061-05	0008-52	0064-08	0037-12	0166-11	0001-51	0099-05	0176-00
KAM2-0100-CAV	0661-16	0669-50	0958-05	0061-04	0008-51	0064-10	0037-14	0166-10	0001-50	0092-39	0176-00
KAMA-0050-TAC	0661-16	0669-50	0958-05							0090-06	0003-00
KAMA-0075-TAC	0661-16	0669-50	0958-05							0090-41	0003-00
KAMA-007E-TAC	0661-16	0669-50	0958-05							0090-41	0003-00
KAMB-0050-CAV	0661-16	0669-50	0958-05	0061-29	0036-05	0064-00	0037-04	0166-09	0001-49	0092-37	0003-00
KAMB-0050-IAA	0661-16	0669-50	0958-05	0061-02	0008-49			0166-08	0001-48	0092-06	0003-00
KAMB-0050-IAB	0661-16	0669-50	0958-05	0061-09	0008-61			0166-09	0001-49	0092-05	0003-00
KAMB-0050-IAH	0661-16	0669-50	0958-05	0061-09	0008-61			0166-09	0001-49	0092-05	0003-00
KAMB-0075-CAA	0661-16	0669-50	0958-05	0061-05	0008-52	0064-08	0037-12	0166-11	0001-51	0092-40	0003-00
KAMB-0075-CAV	0661-16	0669-50	0958-05	0061-04	0008-51	0064-00	0037-04	0166-09	0001-49	0092-29	0003-00
KAMB-0075-IAB	0661-16	0669-50	0958-05	0061-04	0008-51			0166-09	0001-49	0092-27	0003-00
KAMB-0075-IAH	0661-16	0669-50	0958-05	0061-04	0008-51			0166-09	0001-49	0092-27	0003-00

Note: KW water cooled compressors are the same as the KA model having body fin casting except for a factory installed water jacket.

KA - Compressor Parts (air cooled)

Model	Valve Plate Kit	Complete Gasket Kit	Valve Plate Gasket	Start Capacitor		Run Capacitor		Relay		Protector	Terminal Insulator Assembly
	(998-)	(998-)	(020-)	OEM	Service	OEM	Service	OEM	Service		
	(014-)	(914-)	(014-)	(914-)	(040-)	(940-)	(071-)	(580-)			
KAMB-007E-CAA	0661-16	0669-50	0958-05	0061-05	0008-52	0064-08	0037-12	0166-11	0001-51	0092-40	0003-00
KAMB-007E-CAV	0661-16	0669-50	0958-05	0061-04	0008-51	0064-00	0037-04	0166-09	0001-49	0092-29	0003-00
KAMC-0075-TAC	0661-16	0669-50	0958-05							0090-41	0003-00
KAN1-0050-TAC	0661-16	0669-50	0958-05							0090-06	0003-00
KAN1-0075-TAC	0661-16	0669-50	0958-05							0090-41	0003-00
KAN2-0050-CAV	0661-16	0669-50	0958-05	0061-29	0036-05	0064-00	0037-04	0166-09	0001-49	0092-37	0003-00
KAN2-0050-IAA	0661-16	0669-50	0958-05	0061-02	0008-49			0166-08	0001-48	0092-06	0003-00
KAN2-0050-IAB	0661-16	0669-50	0958-05	0061-09	0008-61			0166-09	0001-49	0092-05	0003-00
KAN2-0050-IAH	0661-16	0669-50	0958-05	0061-09	0008-61			0166-09	0001-49	0092-05	0003-00
KAN2-0075-CAA	0661-16	0669-50	0958-05	0061-11	0008-63	0064-06	0037-10	0166-33	0001-75	0099-06	0003-00
KAN2-0075-CAV	0661-16	0669-50	0958-05	0061-04	0008-51	0064-00	0037-04	0166-09	0001-49	0092-41	0003-00
KANA-006E-TAC	0661-16	0669-50	0958-05							0090-21	0003-00
KANA-007E-TAC	0661-16	0669-50	0958-05							0090-41	0003-00
KANB-0050-CAV	0661-16	0669-50	0958-05	0061-29	0036-05	0064-00	0037-04	0166-09	0001-49	0092-37	0003-00
KANB-0050-IAA	0661-16	0669-50	0958-05	0061-02	0008-49			0166-08	0001-48	0092-06	0003-00
KANB-005E-CAV	0661-16	0669-50	0958-05	0061-29	0036-05	0064-00	0037-04	0166-09	0001-49	0092-37	0003-00
KANB-005E-IAA	0661-16	0669-50	0958-05	0061-02	0008-49			0166-08	0001-48	0092-06	0003-00
KAR1-0100-TAC	0661-42	0669-50	0958-07							0090-40	0176-00
KAR1-0100-TAD	0661-42	0669-50	0958-07							0090-42	0176-00
KAR2-0100-CAA	0661-42	0669-50	0958-07	0061-05	0008-52	0064-08	0037-12	0166-11	0001-51	0099-05	0176-00
KAR2-0100-CAV	0661-42	0669-50	0958-07	0061-04	0008-51	0064-10	0037-14	0166-10	0001-50	0092-39	0176-00
KARA-010E-TAC	0661-42	0669-50	0958-07							0090-40	0176-00
KARA-011E-TAD	0661-42	0669-50	0958-07							0090-42	0176-00
KARB-010E-CAV	0661-42	0669-50	0958-07	0061-04	0008-51	0064-10	0037-14	0166-10	0001-50	0092-39	0176-00
KATA-0100-TAC	0661-16	0669-15	0958-04							0090-04	0003-00
KATA-0100-TAD	0661-16	0669-15	0958-04							0090-07	0003-00
KATA-0150-TAC	0661-16	0669-15	0958-06							0090-03	0176-00
KATA-0150-TAD	0661-16	0669-15	0958-06							0090-27	0176-00
KATA-0151-TAC	0661-16	0669-15	0958-06							0090-22	0176-00
KATA-015E-TAC	0661-16	0669-15	0958-06							0090-03	0176-00
KATA-015E-TAD	0661-16	0669-15	0958-06							0090-03	0176-00
KATB-0100-CAA	0661-16	0669-15	0958-04	0061-05	0008-52	0064-08	0037-12	0166-11	0001-51	0092-23	0176-00
KATB-0100-CAB	0661-16	0669-15	0958-04	0061-04	0008-51	0064-00	0037-04	0166-10	0001-50	0092-25	0003-00
KATB-0100-CAH	0661-16	0669-15	0958-04	0061-04	0008-51	0064-00	0037-04	0166-25	0001-66	0092-14	0003-00
KATB-0100-CAV	0661-16	0669-15	0958-04	0061-04	0008-51	0064-10	0037-14	0166-10	0001-50	0092-39	0176-00
KATB-0150-CAB	0661-16	0669-15	0958-06	0061-29	0036-05	0064-10	0037-14	0166-20	0001-61	0092-18	0176-00
KATB-0150-CAH	0661-16	0669-15	0958-06	0061-29	0036-05	0064-10	0037-14	0166-30	0001-71	0092-18	0176-00
KATB-0150-CAV	0661-16	0669-15	0958-06	0061-30	0006-01	0064-19	0037-23	0166-20	0001-61	0099-04	0176-00
KATB-0151-CAB	0661-16	0669-15	0958-06	0061-29	0036-05	0064-19	0037-23	0166-20	0001-61	0092-18	0176-00
KATB-015E-CAV	0661-16	0669-15	0958-06	0061-30	0006-01	0064-19	0037-23	0166-20	0001-61	0099-04	0176-00
KATC-0150-TAC	0661-16	0669-15	0958-06							0090-03	0176-00

Note: KW water cooled compressors are the same as the KA model having body fin casting except for a factory installed water jacket.

L – Semi-Hermetic Compressors

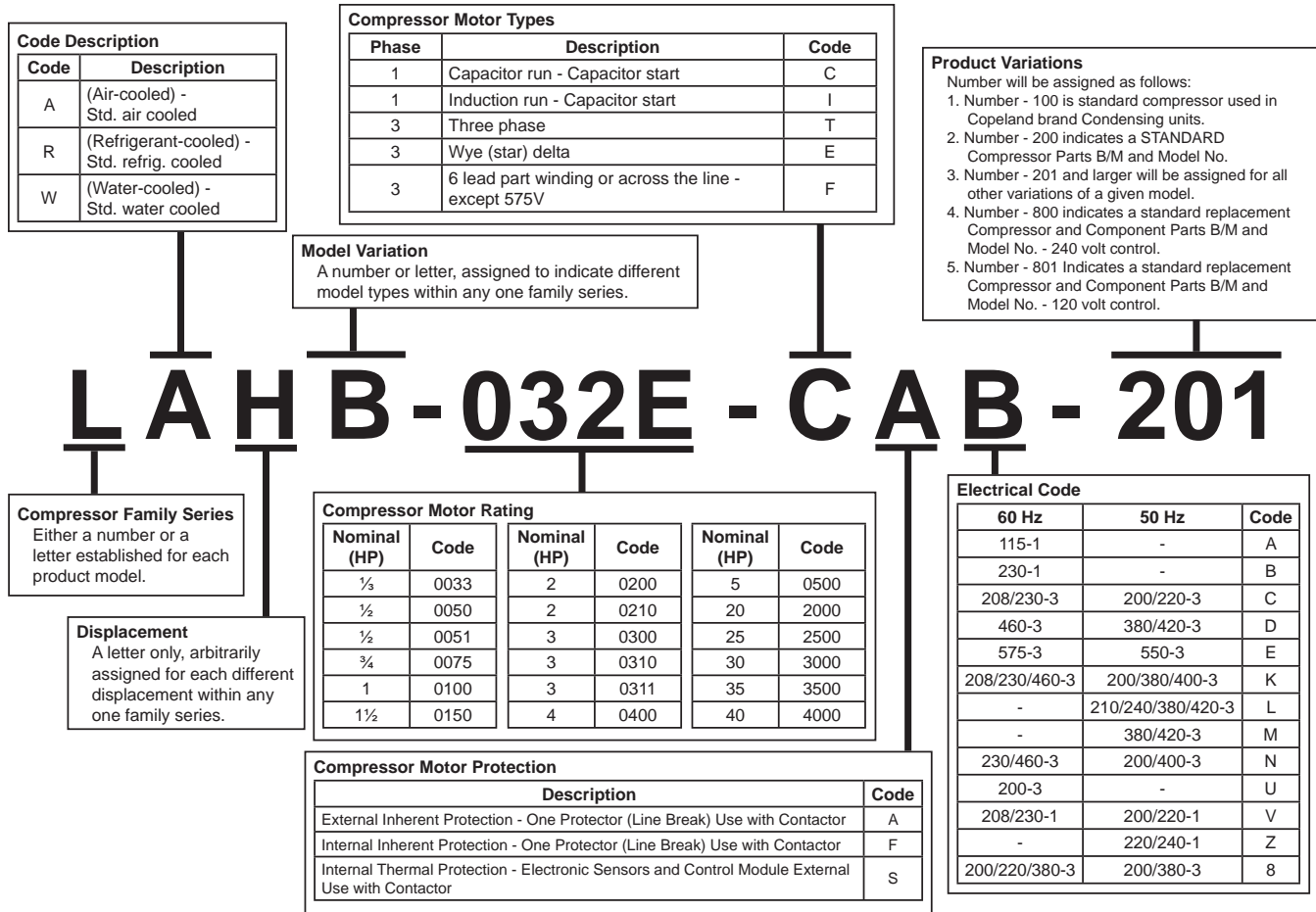

Common Replacement Parts

Common Parts	Part Number
Sight Glass	998-0002-04
Suction Screen	013-0038-00
Cylinder Head Gasket	020-0954-00
Stator Cover Gasket	020-0054-00
Bottom Plate Gasket	020-0159-00
Terminal Plate Gasket	020-0146-00
Housing Cover Gasket	020-0749-00
Suction Valve Adapter Gasket	020-0330-00
Suction Valve Gasket	020-0012-11
Discharge Valve Gasket	020-0012-10
Mounting Assembly	527-0007-00
Cooling Fan Kits	Part Number
120V w/Complete Fan Guard	998-0550-02
240V w/Complete Fan Guard	998-0550-00
460V w/Complete Fan Guard	998-0550-01
Mounting Kit w/Studs	998-0574-00
Crankcase Heater	Part Number
Bolt On 120 Volt 65 Watt	918-0009-00
Bolt On 240 Volt 65 Watt	918-0009-01

Three Phase Only

Common Parts	Part Number
Terminal Fusite	521-0017-00
Terminal Fusite	521-0018-00
Fusite Seal	020-0844-02
Connector T Block	021-0227-02

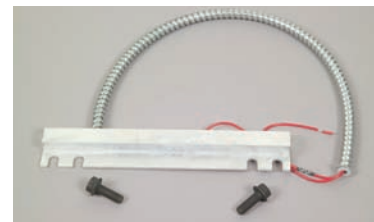

LA - Compressor Parts

Model	Valve Plate Kit	Complete Gasket Kit	Valve Plate Gasket	Start Capacitor		Run Capacitor		Relay		Protector	Terminal Board Assembly	Terminal Insulator Assembly
				OEM	Service	OEM	Service	OEM	Service			
	(998-)	(998-)	(020-)	(014-)	(914-)	(014-)	(914-)	(040-)	(940-)			
LAC1-0300-TAE	0661-37	0669-19	0918-02							0090-14		
LAC1-0310-CAB	0661-37	0669-19	0918-02	0006-13	0006-03	0064-14	0037-18	0166-28	0001-69	0119-01	0010-01	0149-00
LAC1-0310-TAC	0661-37	0669-19	0918-02							0090-01		
LAC1-0310-TAD	0661-37	0669-19	0918-02							0090-03		
LACA-032E-TAC	0661-37	0669-19	0918-02							0090-47		
LACA-032E-TAD	0661-37	0669-19	0918-02							0090-45		
LACB-032E-CAB	0661-37	0669-19	0918-02	0006-13	0006-03	0064-18	0037-22	0166-28	0001-69	0119-05	0010-01	0149-00
LAH1-0300-TAE	0661-37	0669-16	0918-01							0090-14		
LAH1-0310-CAB	0661-37	0669-16	0918-01	0006-13	0006-03	0064-12	0037-16	0166-28	0001-69	0119-01	0010-01	0149-00
LAH1-0310-TAC	0661-37	0669-16	0918-01							0090-19		
LAH1-0310-TAD	0661-37	0669-16	0918-01							0090-03		
LAHA-0310-TAC	0661-37	0669-16	0918-01							0090-19		
LAHA-0310-TAD	0661-37	0669-16	0918-01							0090-03		
LAHA-031E-TAC	0661-37	0669-16	0918-01							0090-19		
LAHA-032E-TAC	0661-37	0669-16	0918-01							0090-47		
LAHA-032E-TAD	0661-37	0669-16	0918-01							0090-45		
LAHA-032E-TAE	0661-37	0669-16	0918-01							0090-14		
LAHB-0311-CAB	0661-37	0669-16	0918-01	0006-13	0006-03	0064-14	0037-18	0166-28	0001-69	0119-05	0010-01	0149-00
LAHB-031E-CAB	0661-37	0669-16	0918-01	0006-13	0006-03	0064-14	0037-18	0166-28	0001-69	0119-05	0010-01	0149-00
LAHB-032E-CAB	0661-37	0669-16	0918-01	0006-13	0006-03	0064-18	0037-22	0166-28	0001-69	0119-05	0010-01	0149-00
LAL1-0300-TAE	0661-37	0669-18	0918-00							0090-14		
LAL1-0310-CAB	0661-37	0669-18	0918-00	0006-13	0006-03	0064-14	0037-18	0166-28	0001-69	0119-01	0010-01	0149-00
LAL1-0310-TAC	0661-37	0669-18	0918-00							0090-18		
LAL1-0310-TAD	0661-37	0669-18	0918-00							0090-03		
LALA-032E-TAC	0661-37	0669-18	0918-00							0090-47		
LALA-032E-TAD	0661-37	0669-18	0918-00							0090-46		
LALB-032E-CAB	0661-37	0669-18	0918-00	0006-13	0006-03	0064-18	0037-22	0166-28	0001-69	0119-05	0010-01	0149-00
LAM1-0300-TAE	0661-37	0669-19	0918-02							0090-13		
LAM1-0310-CAB	0661-37	0669-19	0918-02	0006-13	0006-03	0064-12	0037-16	0166-28	0001-69	0119-01	0010-01	0149-00
LAM1-0310-TAC	0661-37	0669-19	0918-02							0090-01		
LAM1-0310-TAD	0661-37	0669-19	0918-02							0090-03		



A yellow warning tag on an L-model compressor indicates that the oil level should be adjusted to 3/4 sight glass with compressor running, due to more bearing stress and larger journal holes.

M – Semi-Hermetic Compressors

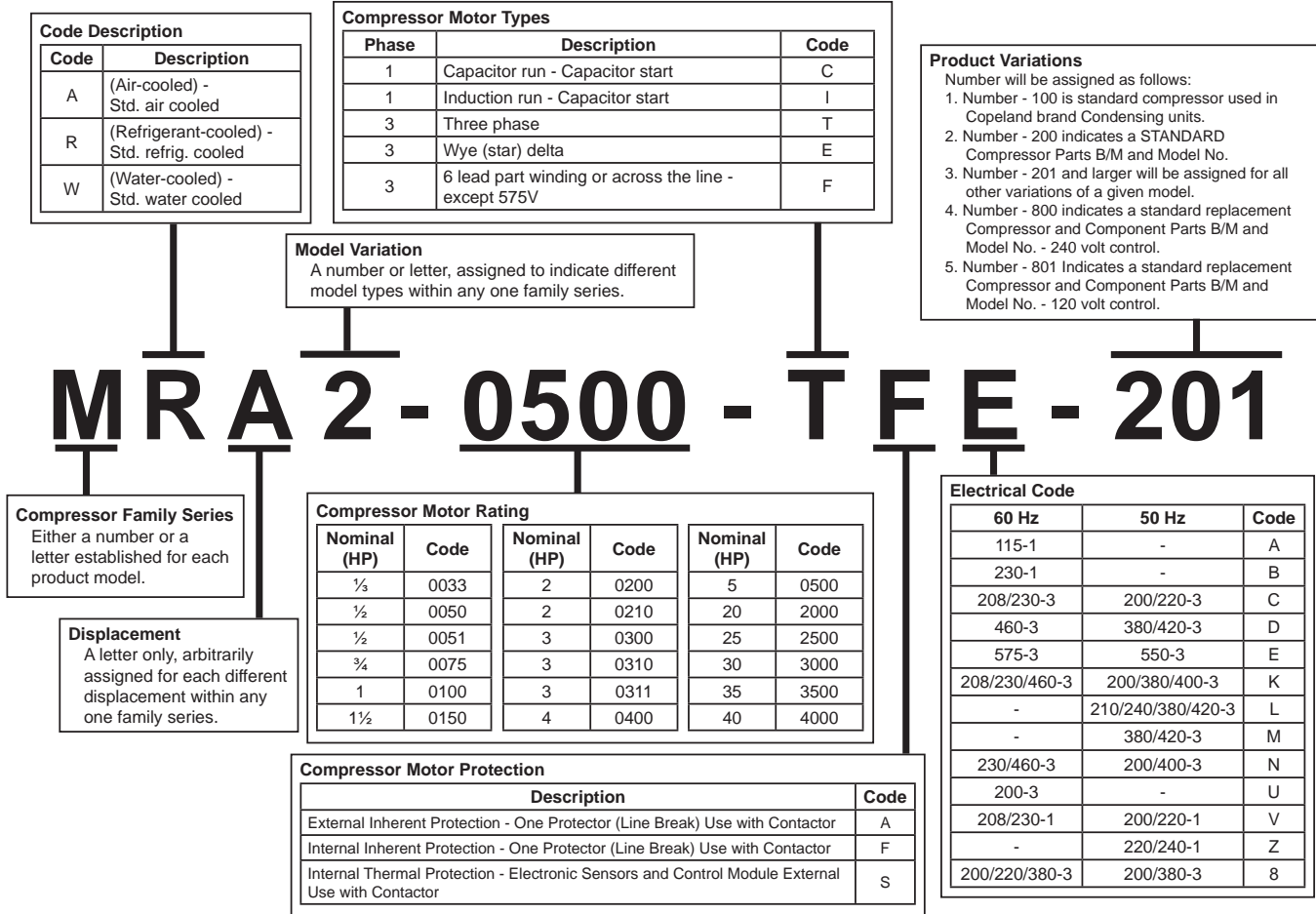

Common Replacement Parts

Common Parts	Part Number
Sight Glass	998-0002-02
Oil Pump Kit	998-0008-33
Suction Strainer Screen Kit	998-0513-04
Gaskets	Part Number
Cylinder Head	020-0604-00
Housing Cover	020-0104-00
Bottom Plate	020-0159-00
Stator Cover	020-0130-00
Terminal Plate	020-0146-00
Oil Pump	020-1204-00
Suction Service Valve to Compressor Body	020-0489-00
Discharge Service Valve to Compressor Body	020-1224-00

Cooling Fan Kits	Part Number
120V w/Complete Fan Guard	998-0550-02
240V w/Complete Fan Guard	998-0550-00
460V w/Complete Fan Guard	998-0550-01
Mounting Kit w/Studs	998-0574-01
Crankcase Heater	Part Number
Bolt On 120 Volt 65 Watt	518-0009-00
Bolt On 240 Volt 65 Watt	518-0009-01
Sentronic 3 Kits and Parts	Part Number
Complete Kit	585-1076-02
Sensor and Cable Kit	998-0162-00
Sensor Only	998-0162-01
Copper Gasket for Sensor	020-0297-13
O-Ring Gasket for Sensor	020-0003-28

MR - Compressor Parts

Model	Valve Plate Kit	Complete Gasket Kit	Valve Plate Gasket	Start Capacitor		Run Capacitor		Relay		Protector	Terminal Plate Group	Terminal Fused Cluster
	(998-)		(020-)	OEM	Service	OEM	Service	OEM	Service			
	(998-)		(020-)	(014-)	(914-)	(014-)	(914-)	(040-)	(940-)			
MRA2-0500-CFB	0661-23	0669-23	0103-00	0006-14	0006-09	0064-18	0037-22	0166-23	0001-64		0144-00	0018-00
MRA2-0500-TFC	0661-23	0669-23	0103-00							071-0086-38	0144-00	0018-00
MRA2-0500-TFD	0661-23	0669-23	0103-00							998-0086-17	0144-00	0018-00
MRA2-0500-TFE	0661-23	0669-23	0103-00							998-0086-29	0144-00	0018-00
MRA2-0506-CFB	0661-23	0669-23	0103-00	0006-14	0006-09	0064-18	0037-22	0166-23	0001-64	998-0476-01	0144-00	0018-00
MRA2-050A-CFB	0661-23	0669-23	0103-00	0006-14	0006-09	0064-18	0037-22	0166-23	0001-64	998-0476-01	0144-00	0018-00
MRA2-050A-TFC	0661-23	0669-23	0103-00							071-0086-38	0144-00	0018-00
MRA2-050A-TFD	0661-23	0669-23	0103-00							998-0086-17	0144-00	0018-00
MRB1-0500-TFC	0661-50	0669-23	0103-04							071-0086-38	0144-00	0018-00
MRB1-0500-TFD	0661-50	0669-23	0103-04							998-0086-35	0144-00	0018-00
MRB1-0500-TFE	0661-50	0669-23	0103-04							998-0086-36	0144-00	0018-00
MRB1-050A-TFC	0661-50	0669-23	0103-04							071-0086-38	0144-00	0018-00
MRB1-050A-TFD	0661-50	0669-23	0103-04							998-0086-35	0144-00	0018-00
MRC1-0500-TFC	0661-54	0669-23	0103-04							071-0086-38	0144-00	0018-00
MRC1-0500-TFD	0661-54	0669-23	0103-04							998-0086-35	0144-00	0018-00
MRF2-0500-CFB	0661-17	0669-23	0103-00	0006-14	0006-09	0064-18	0037-22	0166-23	0001-64		0144-00	0018-00
MRF2-0500-TFC	0661-17	0669-23	0103-00							071-0086-38	0144-00	0018-00
MRF2-0500-TFD	0661-17	0669-23	0103-00							998-0086-17	0144-00	0018-00
MRF2-0500-TFE	0661-17	0669-23	0103-00							998-0086-29	0144-00	0018-00
MRF2-0506-CFB	0661-17	0669-23	0103-00	0006-14	0006-09	0064-18	0037-22	0166-23	0001-64	998-0476-01	0144-00	0018-00
MRF2-050A-CFB	0661-17	0669-23	0103-00	0006-14	0006-09	0064-18	0037-22	0166-23	0001-64	998-0476-01	0144-00	0018-00
MRF2-050A-TFC	0661-17	0669-23	0103-00							071-0086-38	0144-00	0018-00
MRF2-050A-TFD	0661-17	0669-23	0103-00							998-0086-17	0144-00	0018-00
MRH4-0760-TFC	0661-17	0669-52	0103-02							998-0086-21	0144-00	0018-00
MRH4-0760-TFD	0661-17	0669-52	0103-02							998-0086-20	0144-00	0018-00
MRH4-0760-TFE	0661-17	0669-52	0103-02							998-0086-40	0144-00	0018-00
MRH4-076A-TFC	0661-17	0669-52	0103-02							998-0086-21	0144-00	0018-00
MRH4-076A-TFD	0661-17	0669-52	0103-02							998-0086-20	0144-00	0018-00

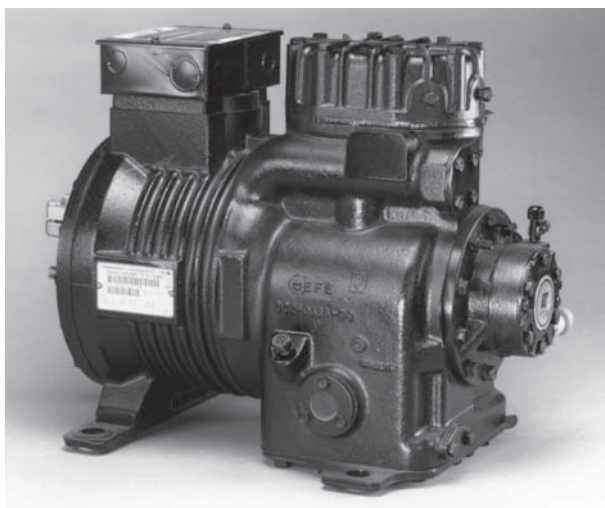

N – Semi-Hermetic Compressors

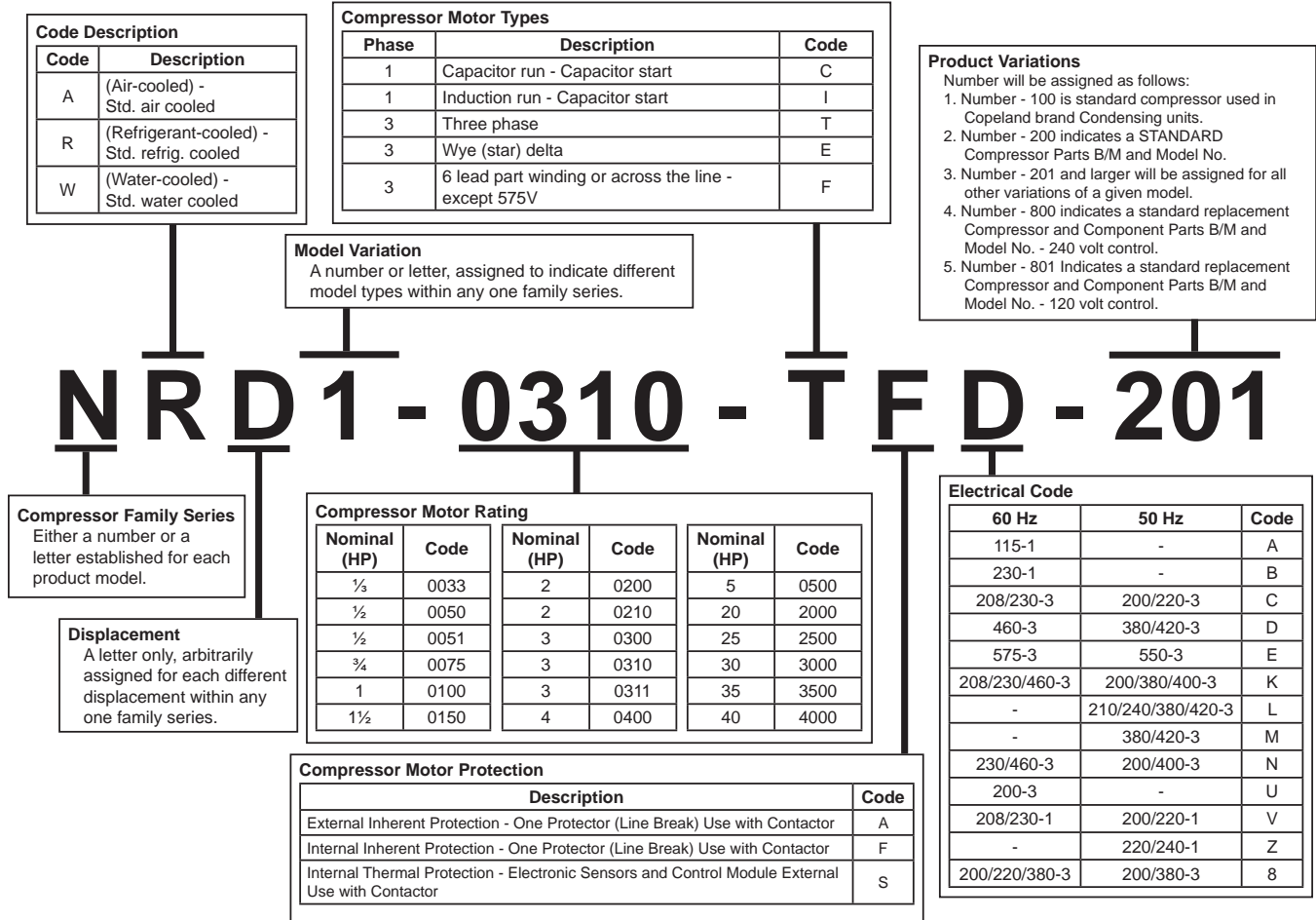

Common Replacement Parts

Common Parts	Part Number
Sight Glass Kit	998-0002-02
Oil Pump Kit	998-0008-33
Suction Screen	013-0010-00
Terminal Fused Cluster (Fusite)	521-0018-00
Terminal Fused Seal (Fusite)	020-0844-02
Gaskets	Part Number
Cylinder Head	020-0954-00
Housing Cover	020-0749-00
Bottom Plate	020-0159-00
Stator Cover	020-0054-00
Terminal Plate Gasket	020-0146-00
Oil Pump Gasket	020-1204-00
Suction or Discharge Valve to Compressor Body	020-1224-00

Cooling Fan Kits	Part Number
120V w/Complete Fan Guard	998-0550-02
240V w/Complete Fan Guard	998-0550-00
460V w/Complete Fan Guard	998-0550-01
Mounting Kit w/Studs	998-0574-02
Crankcase Heater	Part Number
120 Volt 65 Watt	918-0009-00
240 Volt 65 Watt	918-0009-01
Sentronic 3 Kits and Parts	Part Number
Complete Kit	585-1076-02
Sensor and Cable Kit	998-0162-00
Sensor Only	998-0162-01
Copper Gasket for Sensor	020-0297-13
O-Ring Gasket for Sensor	020-0003-28

NR - Compressor Parts

Model	Valve Plate Kit	Complete Gasket Kit	Valve Plate Gasket	Start Capacitor		Run Capacitor		Relay		Protector	Terminal Insulator Assembly
	(998-)	(998-)	(020-)	OEM	Service	OEM	Service	OEM	Service		
	(014-)	(914-)	(014-)	(914-)	(040-)	(940-)	(580-)				
NRA2-0500-CFB	0661-58	0669-49	0918-04	0006-14	0006-09	0064-22	0037-26	0166-20	0001-61		0018-00
NRA2-0500-TFC	0661-58	0669-49	0918-04							998-0086-39	0018-00
NRA2-0500-TFD	0661-58	0669-49	0918-04							998-0086-14	0018-00
NRA2-0500-TFE	0661-58	0669-49	0918-04							998-0086-17	0018-00
NRB2-0310-CFB	0661-58	0669-49	0918-03	0006-13	0006-03	0064-12	0037-16	0166-28	0001-69	071-0128-00	0018-00
NRB2-0310-TFC	0661-58	0669-49	0918-03							998-0086-11	0018-00
NRB2-0310-TFD	0661-58	0669-49	0918-03							998-0086-37	0018-00
NRB2-0400-CFB	0661-58	0669-49	0918-03	0006-13	0006-03	0064-11	0037-15	0166-30	0001-71		0018-00
NRB2-0400-TFC	0661-58	0669-49	0918-03							998-0086-39	0018-00
NRB2-0400-TFD	0661-58	0669-49	0918-03							998-0086-14	0018-00
NRB2-0400-TFE	0661-58	0669-49	0918-03							998-0086-17	0018-00
NRD1-0310-TFC	0661-59	0669-49	0918-02							998-0086-11	0018-00
NRD1-0310-TFD	0661-59	0669-49	0918-02							998-0086-37	0018-00
NRD1-0310-TFE	0661-59	0669-49	0918-02							998-0429-09	0018-00
NRD1-032E-TFC	0661-59	0669-49	0918-02							071-0429-30	0018-00
NRD1-0400-CFB	0661-59	0669-49	0918-02	0006-14	0006-09	0064-14	0037-18	0166-28	0001-69	998-0476-01	0018-00
NRD1-0406-CFB	0661-59	0669-49	0918-02	0006-14	0006-09	0064-14	0037-18	0166-28	0001-69	998-0476-01	0018-00
NRD1-040E-CFB	0661-59	0669-49	0918-02	0006-14	0006-09	0064-14	0037-18	0166-28	0001-69	998-0476-01	0018-00
NRM1-0500-CFB	0661-58	0669-49	0918-01	0006-14	0006-09	0064-22	0037-26	0166-20	0001-61		0018-00
NRM1-0500-TFC	0661-58	0669-49	0918-01							998-0086-39	0018-00
NRM1-0500-TFD	0661-58	0669-49	0918-01							998-0086-14	0018-00
NRM1-0500-TFE	0661-58	0669-49	0918-01							998-0086-17	0018-00
NRN2-0310-CFB	0661-37	0669-49	0918-01	0006-14	0006-09	0064-12	0037-16	0166-28	0001-69	071-0128-00	0018-00
NRN2-0310-TFC	0661-37	0669-49	0918-01							998-0086-11	0018-00
NRN2-0310-TFD	0661-37	0669-49	0918-01							998-0086-37	0018-00

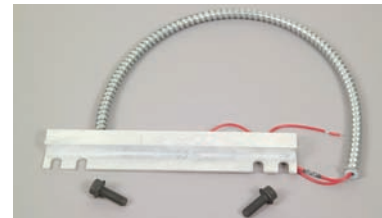
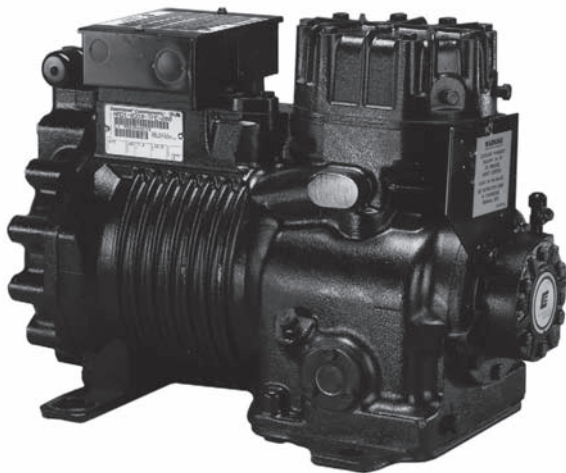

2D – Semi-Hermetic Compressors

Compressor Cooling	
Code	Description
A	Air cooled
D	Discus
R	Refrigerant cooled
T	Std. two stage
W	Water cooled

Comp. Motor Rating Nominal					
HP	Code	HP	Code	HP	Code
1/4	0025	2-3/4	0275	15	1500
1/3	0033	3 (0310)	0300	20	2000
1/2	0050	3-1/2	0350	25	2500
3/4	0075	4 (0406)	0400	30	3000
1	0100	5 (0506)	0500	35	3500
1-1/4	0125	6	0600	40	4000
1-1/2	0150	7-1/2 (0766)	0750	50	5000
1-3/4	0175	9	0900	60	6000
2	0200	10 (1015)	1000		
2-1/2	0250	12	1200		

Compressor Motor Type	
Single Phase Motors	Code
Capacitor run - Capacitor start	C
Induction run - Capacitor start	I
Induction run - Split phase	S
Induction run - Capacitor start, low torque	X
Three Phase Motors	
General	Code
3 Lead single voltage	T
6 Lead part winding (575 volt)	
9 Lead dual voltage	
Star (wye) delta	E
6 Lead motors	F
Part winding or across the line	

Product Variations
Numbers will be assigned as follows:

- Numbers -001 through -199 are reserved for sub+b/m numbers.
- Numbers -200 indicates a standard compressor and component parts b/m and model no.
- Numbers -201 and larger will be assigned for all other variations of a given model.

Tandem Style Models
Indicated by the digit representing the comp. model series connected in tandem with a comp. of the model series indicated by the first digit.

May be = (-) or A

Note: Nominal horsepower rating of tandem compressors is sum of individual compressor ratings

2DA3 - 0750 - TFE 800

Compressor Family Series
Either a number or a letter established for each product family.

Displacement and Valve Plate
A letter only, arbitrarily assigned for each different displacement within any one family series.

Model Variation
A number or letter, assigned to indicate different model types within any family series.

May also be
"A" = (Alkylbenzene)
"E" = (POE Oil)
"L" = (Less Oil)

Compressor Motor Protection	
Description	Code
External inherent protection - one protector (line break) use with contactor	A
Internal inherent protection - one protector use with contactor	F
Internal thermostat(s); and ext, supplementary protector(s) use with contactor.	H
Internal thermostat(s); and three ext, supplementary protector(s) use with contactor.	L
Internal thermal protectors - electronic sensors; and control module external. Use with contactor.	S
Internal thermal protectors - electronic sensors; and control module external. use with contactor (For European use only).	W

Electrical Codes					
60 Hz	50 Hz	Code	60 Hz	50 Hz	Code
115-1	100-1	A	-	220-1	S
230-1	200-1	B	-	200-1	T
5206-230-3	200/220-3	C	200-3	-	U
460-3	380/400-3	D	208-230-1	200-1	V
575-3	500-3	E	-	200/220-3	W
-	115-1	F	Misc. A.C. Ratings	X	
-	230-1	G	-	500-3	Y
208-1	200-1	H	-	220/240-1	Z
-	208/230-1	I	200-1	200-1	3
208/230/460-3	200/400-3	K	100-1	100-1	4
-	210/240/380-3	L	200-230-3	-	5
-	380-/420-3	M	230-3	-	6
230/460-3	200/400-3	N	380	346	7
-	200/380-3	P	200/220/380	200/345	8
-	200/240-3	R			

* When applicable, specific 50 HZ ratings (Not necessarily identical to typical shown above) will be shown as alternate on 60 HZ rated models.

Semi-Hermetic Compressors – 2D

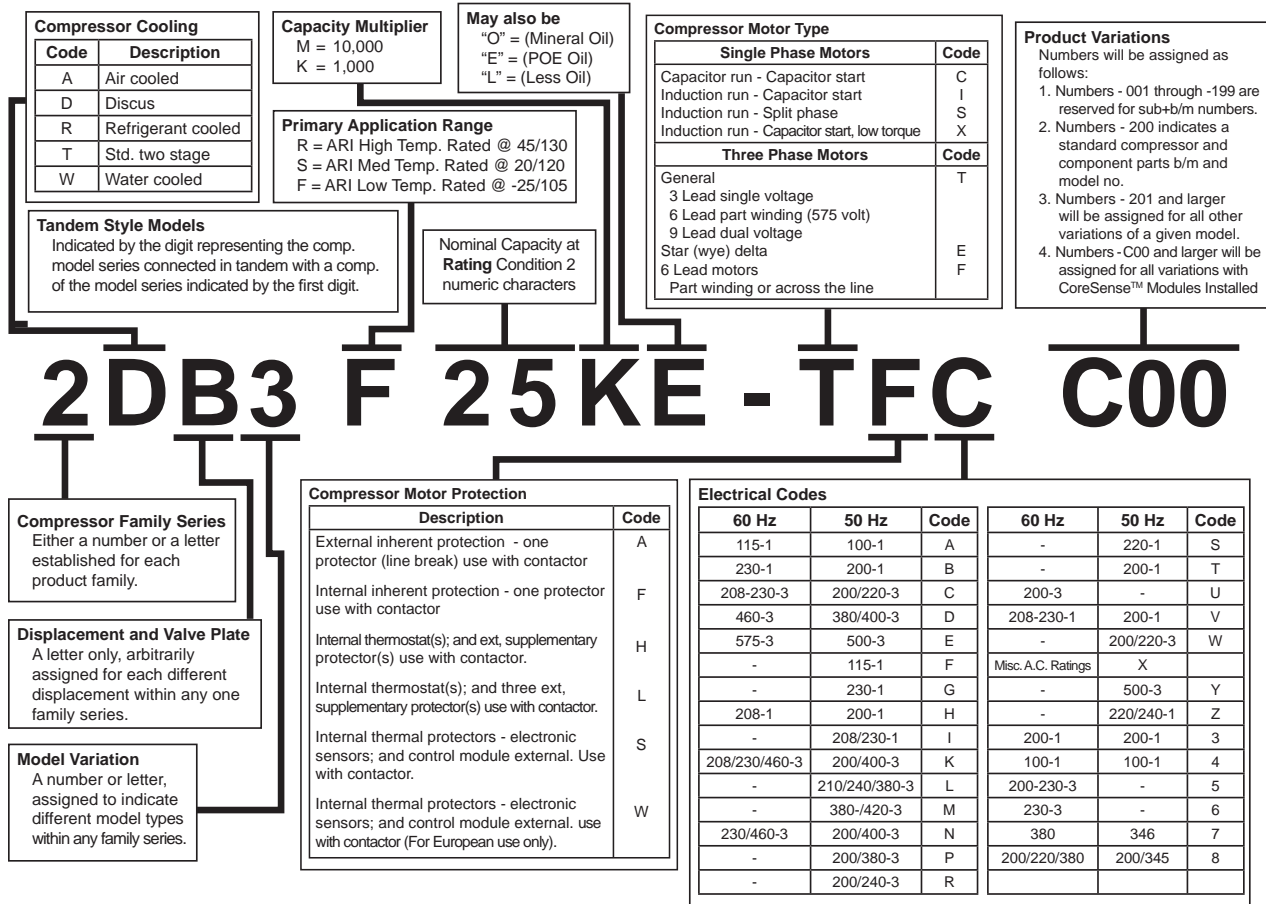

2D – Semi-Hermetic Compressors

Common Replacement Parts

Common Parts	Part Number
Sight Glass Kit	998-0002-02
Sight Glass O-Ring	020-0844-05
Oil Check Valve Assembly	510-0142-00
Oil Screen Kit	998-0513-03
Oil Pump Kit	998-0008-33
Terminal Fused Cluster	521-0018-00
Terminal Fused Cluster Seal	020-0844-02
Gaskets	Part Number
Cylinder Head	020-0756-00
Housing Cover	020-0104-00
Stator Cover	020-0709-00
Bottom Plate	020-1201-00
Oil Pump	020-1204-00
Gasket Kit (Complete)	998-1669-06
Crankcase Heater	Part Number
120 Volt 100 Watt	518-0028-06
240 Volt 100 Watt	518-0028-07
Crankcase Heater Well	030-0187-01
CoreSense™ Parts	Part Number
CoreSense Module	943-0109-00
2D CoreSense Wiring Harness	929-0097-00
CoreSense DLT Thermistor	085-0109-00
Current Sensor Kit	943-0064-00
Sensor Only	998-0162-01
Copper Gasket for Sensor	020-0297-13
O-Ring Gasket for Sensor	020-0003-28



Rotalock Adaptor Pad	Part Number
Adaptor Pad to Rotalock Kit	998-0036-02
Adaptor Pad	036-0505-00
Suction Valve Seal	020-0028-02
Service Valve Gasket	020-0012-11
Bolts	100-0172-00
Demand Cooling	Part Number
Demand Cooling Kit- 120 Volt	998-1000-12
Demand Cooling Kit- 240 Volt	998-1000-22
120 Volt Control Only	085-0110-00
240 Volt Control Only	085-0110-01
Sensor Only	085-0109-00
Cooling Fan Kits	Part Number
120V w/Bottom Fan Guard	998-0550-05
120V w/Complete Fan Guard	998-0550-02
240V w/Bottom Fan Guard	998-0550-03
240V w/Complete Fan Guard	998-0550-00
460V w/Bottom Fan Guard	998-0550-04
460V w/Complete Fan Guard	998-0550-01
Mounting Kit w/Studs	998-0574-11
Fan Blade	083-0118-00
Top Guard	024-0200-00
Sentronic 3 Kits and Parts	Part Number
Complete Kit	585-1076-02
Sensor and Cable Kit	998-0162-00
Sensor Only	998-0162-01
Copper Gasket for Sensor	020-0297-13
O-Ring Gasket for Sensor	020-0003-28



2D - Compressor Parts

Model HP Nomenclature	Model BTU Nomenclature	Valve Plate Kit (998-)	Valve Plate Gasket (020-)	Start Capacitor		Run Capacitor		Relay		Motor Protector Kit (998-)	Terminal Plate Assembly (521-)
				OEM	Service	OEM	Service	OEM	Service		
				(014-)	(914-)	(014-)	(914-)	(040-)	(940-)		
2DA3-0500-TFC	2DA3R58K0-TFC	1661-29	0757-05							0429-02	0144-00
2DA3-0500-TFD	2DA3R58K0-TFD	1661-29	0757-05							0429-10	0144-00
2DA3-0500-TFE	2DA3R58K0-TFE	1661-29	0757-05							0429-23	0144-00
2DA3-0600-TFC	2DA3F23K0-TFC	1661-29	0757-05							0429-08	0144-00
2DA3-0600-TFD	2DA3F23K0-TFD	1661-29	0757-05							0429-10	0144-00
2DA3-0600-TFE	2DA3F23K0-TFE	1661-29	0757-05							0429-18	0144-00
2DA3-060E-TFC	2DA3F23KE-TFC	1661-29	0757-05							0429-08	0144-00
2DA3-060E-TFD	2DA3F23KE-TFD	1661-29	0757-05							0429-10	0144-00
2DA3-060E-TFE	2DA3F23KE-TFE	1661-29	0757-05							0429-18	0144-00
2DA3-0750-TFC	2DA3R89K0-TFC	1661-23	0757-05							0429-08	0144-00
2DA3-0750-TFD	2DA3R89K0-TFD	1661-23	0757-05							0429-05	0144-00
2DA3-0750-TFE	2DA3R89K0-TFE	1661-23	0757-05							0429-25	0144-00
2DA3-075E-TFC	2DA3R89KE-TFC	1661-23	0757-05							0429-08	0144-00
2DA3-075E-TFD	2DA3R89KE-TFD	1661-23	0757-05							0429-05	0144-00
2DA3-075E-TFE	2DA3R89KE-TFE	1661-23	0757-05							0429-25	0144-00
2DB3-0490-TFC	N/A	1661-29	0757-01							0429-08	0144-00
2DB3-0500-TFC	2DB3F25K0-TFC	1661-29	0757-01							0429-02	0144-00
2DB3-0500-TFD	2DB3F25K0-TFD	1661-29	0757-01							0429-10	0144-00
2DB3-0500-TFE	2DB3F25K0-TFE	1661-29	0757-01							0429-23	0144-00
2DB3-0600-TFC	2DB3F25K0-TFC	1661-29	0757-01							0429-08	0144-00
2DB3-0600-TFD	2DB3F25K0-TFD	1661-29	0757-01							0429-05	0144-00
2DB3-0600-TFE	2DB3F25K0-TFE	1661-29	0757-01							0429-26	0144-00
2DB3-060E-TFC	2DB3F25KE-TFC	1661-29	0757-01							0429-08	0144-00
2DB3-060E-TFD	2DB3F25KE-TFD	1661-29	0757-01							0429-05	0144-00
2DB3-060E-TFE	2DB3F25KE-TFE	1661-29	0757-01							0429-26	0144-00
2DC3-0500-CFB	2DC3R53K0-CFB	1661-23	0757-03	0006-09	0006-09	0064-18	0037-22	0166-23	0001-64	0476-01	0144-00
2DC3-0500-TFC	2DC3R53K0-TFC	1661-23	0757-03							0429-13	0144-00
2DC3-0500-TFD	2DC3R53K0-TFD	1661-23	0757-03							0429-10	0144-00
2DC3-0500-TFE	2DC3R53K0-TFE	1661-23	0757-03							0429-23	0144-00
2DC3-050E-TFC	2DC3R53KE-TFC	1661-23	0757-03							0429-13	0144-00
2DC3-050E-TFD	2DC3R53KE-TFD	1661-23	0757-03							0429-10	0144-00
2DC3-050E-TFE	2DC3R53KE-TFE	1661-23	0757-03							0429-23	0144-00
2DD3-0500-TFC	2DD3R63K0-TFC	1661-23	0757-03							0429-24	0144-00
2DD3-0500-TFD	2DD3R63K0-TFD	1661-23	0757-03							0429-10	0144-00
2DD3-0500-TFE	2DD3R63K0-TFE	1661-23	0757-03							0429-23	0144-00
2DD3-050E-TFC	2DD3R63KE-TFC	1661-23	0757-03							0429-24	0144-00
2DD3-050E-TFD	2DD3R63KE-TFD	1661-23	0757-03							0429-10	0144-00
2DD3-050E-TFE	2DD3R63KE-TFE	1661-23	0757-03							0429-23	0144-00

2D – Semi-Hermetic Compressors

2D - Compressor Parts

Model HP Nomenclature	Model BTU Nomenclature	Valve Plate Kit (998-)	Valve Plate Gasket (020-)	Start Capacitor		Run Capacitor		Relay		Motor Protector Kit (998-)	Terminal Plate Assembly (521-)
				OEM	Service	OEM	Service	OEM	Service		
				(014-)	(914-)	(014-)	(914-)	(040-)	(940-)		
2DF3-0300-CFB	2DF3F16K0-CFB	1661-29	0757-01	0006-09	0006-09	0064-18	0037-22	0166-23	0001-64	0476-01	0144-00
2DF3-0300-TFC	2DF3F16K0-TFC	1661-29	0757-01							0429-22	0144-00
2DF3-0300-TFD	2DF3F16K0-TFD	1661-29	0757-01							0429-23	0144-00
2DF3-0300-TFE	2DF3F16K0-TFE	1661-29	0757-01							0429-27	0144-00
2DF3-030E-CFB	2DF3F16KE-CFB	1661-29	0757-01	0006-09	0006-09	0064-18	0037-22	0166-23	0001-64	0476-01	0144-00
2DF3-030E-TFC	2DF3F16KE-TFC	1661-29	0757-01							0429-22	0144-00
2DF3-030E-TFD	2DF3F16KE-TFD	1661-29	0757-01							0429-23	0144-00
2DF3-030E-TFE	2DF3F16KE-TFE	1661-29	0757-01							0429-27	0144-00
2DL3-0400-TFC	2DL3F20K0-TFC	1661-29	0757-03							0429-08	0144-00
2DL3-0400-TFD	2DL3F20K0-TFD	1661-29	0757-03							0429-10	0144-00
2DL3-0400-TFE	2DL3F20KE-TFE	1661-29	0757-03							0429-23	0144-00
2DL3-040E-TFC	2DL3F20KE-TFC	1661-29	0757-03							0429-08	0144-00
2DL3-040E-TFD	2DL3F20KE-TFD	1661-29	0757-03							0429-10	0144-00
2DL3-040E-TFE	2DL3F20KE-TFE	1661-29	0757-03							0429-23	0144-00
2DL3-0750-TFC	2DL3R78K0-TFC	1661-23	0757-03							0429-08	0144-00
2DL3-0750-TFD	2DL3R78K0-TFD	1661-23	0757-03							0429-05	0144-00
2DL3-0750-TFE	2DL3R78K0-TFE	1661-23	0757-03							0429-25	0144-00
2DL3-075E-TFC	2DL3R78KE-TFC	1661-23	0757-03							0429-08	0144-00
2DL3-075E-TFD	2DL3R78KE-TFD	1661-23	0757-03							0429-05	0144-00
2DL3-075E-TFE	2DL3R78KE-TFE	1661-23	0757-03							0429-25	0144-00



Semi-Hermetic Compressors – 3A and 3R

Compressor Cooling	
Code	Description
A	Air cooled
D	Discus
R	Refrigerant cooled
T	Std. two stage
W	Water cooled

Comp. Motor Rating Nominal					
HP	Code	HP	Code	HP	Code
1/4	0025	2-3/4	0275	15	1500
1/3	0033	3 (0310)	0300	20	2000
1/2	0050	3-1/2	0350	25	2500
3/4	0075	4 (0406)	0400	30	3000
1	0100	5 (0506)	0500	35	3500
1-1/4	0125	6	0600	40	4000
1-1/2	0150	7-1/2 (0766)	0750	50	5000
1-3/4	0175	9	0900	60	6000
2	0200	10 (1015)	1000		
2-1/2	0250	12	1200		

Compressor Motor Type	
Single Phase Motors	Code
Capacitor run - Capacitor start	C
Induction run - Capacitor start	I
Induction run - Split phase	S
Induction run - Capacitor start, low torque	X
Three Phase Motors	Code
General	T
3 Lead single voltage	
6 Lead part winding (575 volt)	
9 Lead dual voltage	
Star (wye) delta	E
6 Lead motors	F
Part winding or across the line	

Product Variations	
Numbers will be assigned as follows:	
1. Numbers -001 through -199 are reserved for sub+b/m numbers.	
2. Numbers -200 indicates a standard compressor and component parts b/m and model no.	
3. Numbers -201 and larger will be assigned for all other variations of a given model.	

May be = (-) or A

Note: Nominal horsepower rating of tandem compressors is sum of individual compressor ratings

3ABB - 032E - CAB 800

Compressor Motor Protection	
Description	Code
External inherent protection - one protector (line break) use with contactor	A
Internal inherent protection - one protector use with contactor	F
Internal thermostat(s); and ext, supplementary protector(s) use with contactor.	H
Internal thermostat(s); and three ext, supplementary protector(s) use with contactor.	L
Internal thermal protectors - electronic sensors; and control module external. Use with contactor.	S
Internal thermal protectors - electronic sensors; and control module external. use with contactor (For European use only).	W

Electrical Codes					
60 Hz	50 Hz	Code	60 Hz	50 Hz	Code
115-1	100-1	A	-	220-1	S
230-1	200-1	B	-	200-1	T
5206-230-3	200/220-3	C	200-3	-	U
460-3	380/400-3	D	208-230-1	200-1	V
575-3	500-3	E	-	200/220-3	W
-	115-1	F	Misc. A.C. Ratings	X	
-	230-1	G	-	500-3	Y
208-1	200-1	H	-	220/240-1	Z
-	208/230-1	I	200-1	200-1	3
208/230/460-3	200/400-3	K	100-1	100-1	4
-	210/240/380-3	L	200-230-3	-	5
-	380/420-3	M	230-3	-	6
230/460-3	200/400-3	N	380	346	7
-	200/380-3	P	200/220/380	200/345	8
-	200/240-3	R			

Compressor Family Series	
Either a number or a letter established for each product family.	

Displacement and Valve Plate	
A letter only, arbitrarily assigned for each different displacement within any one family series.	

Model Variation	
A number or letter, assigned to indicate different model types within any family series.	

May also be	
"A" = (Alkylbenzene)	
"E" = (POE Oil)	
"L" = (Less Oil)	

* When applicable, specific 50 HZ ratings (Not necessarily identical to typical shown above) will be shown as alternate on 60 HZ rated models.

Common Replacement Parts

Common Parts	Part Number
Sight Glass Kit	998-0002-04
Suction Strainer Screen	013-0010-00
Terminal Fused Cluster	521-0017-00
Terminal Fused Cluster Seal	020-0844-02
Gaskets	Part Number
Complete Gasket Set for 3A Compressors	998-0669-24
Complete Gasket Set for 3R Compressors	998-0669-25
Crankcase Heater	Part Number
Bolt on 120 Volt 65 Watt	918-0009-00
Bolt On 240 Volt 65 Watt	918-0009-01

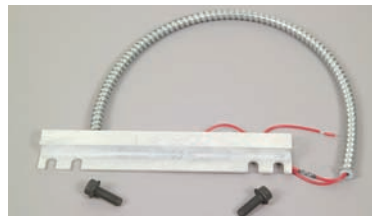
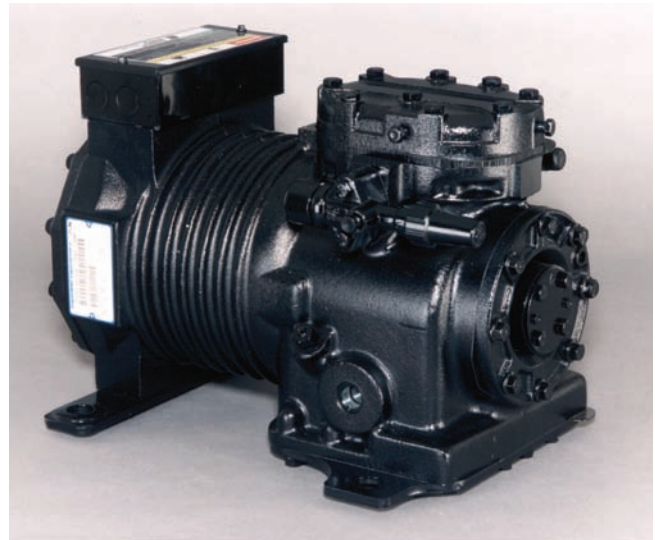

3A and 3R – Semi-Hermetic Compressors

3A - Compressor Parts

Model	Valve Plate Kit	Valve Plate Gasket	Start Capacitor		Run Capacitor		Relay		Protector	Terminal Board Assembly	Terminal Insulator Assembly
			OEM	Service	OEM	Service	OEM	Service			
	(998-)	(020-)	(014-)	(914-)	(014-)	(914-)	(040-)	(940-)			
3AB1-0300-TAE	0661-44	0112-02							0090-16	0052-02	0067-01
3AB1-0310-TAC	0661-44	0112-02							0090-01	0052-01	0067-01
3AB1-0310-TAD	0661-44	0112-02							0090-03	0052-02	0067-01
3AB1-0311-TAC	0661-44	0112-02							0090-37	0052-01	0067-01
3AB1-0311-TAD	0661-44	0112-02							0090-03	0052-02	0067-01
3AB2-0310-CAB	0661-44	0112-02	0006-13	0006-03	0064-12	0037-16	0166-28	0001-69	0119-01	0050-00	0067-01
3ABA-031E-TAC	0661-44	0112-02							0090-37	0052-01	0067-01
3ABA-031E-TAD	0661-44	0112-02							0090-03	0052-02	0067-01
3ABB-032E-CAB	0661-44	0112-02	0006-13	0006-03	0064-14	0037-18	0166-28	0001-69	0119-02	0050-00	0067-01
3AH1-0200-TAC	0661-21	0112-00							0090-00	0052-02	0067-01
3AH1-0200-TAD	0661-21	0112-00							0090-08	0052-02	0067-01
3AH1-0200-TAE	0661-21	0112-00							0090-15	0052-00	0067-01
3AH2-0200-CAB	0661-21	0112-00	0061-30	0006-01	0064-11	0037-15	0166-20	0001-61	0092-18	0051-00	0067-01
3AH2-0200-CAH	0661-21	0112-00	0061-30	0006-01	0064-11	0037-15	0166-20	0001-61	0089-00	0051-00	0067-01
3AJ1-0200-TAC	0661-21	0112-01							0090-00	0052-02	0067-01
3AJ1-0200-TAD	0661-21	0112-01							0090-08	0052-02	0067-01
3AJ1-0200-TAE	0661-21	0112-01							0090-15	0052-00	0067-01
3AJ2-0200-CAB	0661-21	0112-01	0061-30	0006-01	0064-11	0037-15	0166-20	0001-61	0092-18	0051-00	0067-01
3AJ2-0200-CAH	0661-21	0112-01	0061-30	0006-01	0064-11	0037-15	0166-20	0001-61	0092-18	0051-00	0067-01
3AJ2-0310-CAB	0661-21	0112-01	0006-13	0006-03	0064-12	0037-16	0166-28	0001-69	0119-01	0050-00	0067-01
3AJA-0210-TAC	0661-21	0112-01							0090-44	0052-01	0067-01
3AJB-0210-CAB	0661-21	0112-01	0006-13	0006-03	0064-12	0037-16	0166-28	0001-69	0119-05	0051-00	0067-01

Note: 3W water cooled compressors are the same as the 3A model having body fin casting except for a factory installed water jacket.

3R - Compressor Parts

Model	Valve Plate Kit	Valve Plate Gasket	Start Capacitor		Run Capacitor		Relay		Protector	Terminal Board Assembly	Terminal Insulator Assembly
			OEM	Service	OEM	Service	OEM	Service			
	(998-)	(020-)	(014-)	(914-)	(014-)	(914-)	(040-)	(940-)			
3RA1-0310-TAC	0661-20	0112-00							0090-17	0052-01	0067-01
3RA1-0310-TAD	0661-20	0112-00							0090-22	0052-02	0067-01
3RA1-0311-TAC	0661-20	0112-00							0090-32	0052-01	0067-01
3RA1-0311-TAD	0661-20	0112-00							0090-22	0052-02	0067-01
3RA2-0310-CAB	0661-20	0112-00	0061-30	0006-01	0064-14	0037-18	0166-28	0001-69	0119-02	0050-00	0067-01
3RAA-031E-TAC	0661-20	0112-00							0090-32	0052-01	0067-01
3RAA-031E-TAD	0661-20	0112-00							0090-22	0052-02	0067-01
3RK1-0300-TAE	0661-20	0113-00							0090-16	0052-02	0067-01
3RK1-0310-TAC	0661-20	0113-00							0090-02	0052-01	0067-01
3RK1-0310-TAD	0661-20	0113-00							0090-03	0052-02	0067-01
3RK2-0310-CAB	0661-20	0113-00	0061-30	0006-01	0064-14	0037-18	0166-28	0001-69	0119-00	0050-00	0067-01

Semi-Hermetic Compressors – 3D

Compressor Cooling	
Code	Description
A	Air cooled
D	Discus
R	Refrigerant cooled
T	Std. two stage
W	Water cooled

Comp. Motor Rating Nominal					
HP	Code	HP	Code	HP	Code
1/4	0025	2-3/4	0275	15	1500
1/3	0033	3 (0310)	0300	20	2000
1/2	0050	3-1/2	0350	25	2500
3/4	0075	4 (0406)	0400	30	3000
1	0100	5 (0506)	0500	35	3500
1-1/4	0125	6	0600	40	4000
1-1/2	0150	7-1/2 (0766)	0750	50	5000
1-3/4	0175	9	0900	60	6000
2	0200	10 (1015)	1000		
2-1/2	0250	12	1200		

Compressor Motor Type	
Single Phase Motors	Code
Capacitor run - Capacitor start	C
Induction run - Capacitor start	I
Induction run - Split phase	S
Induction run - Capacitor start, low torque	X
Three Phase Motors	Code
General	T
3 Lead single voltage	
6 Lead part winding (575 volt)	
9 Lead dual voltage	
Star (wye) delta	E
6 Lead motors	F
Part winding or across the line	

Product Variations
Numbers will be assigned as follows:
1. Numbers -001 through -199 are reserved for sub+b/m numbers.
2. Numbers -200 indicates a standard compressor and component parts b/m and model no.
3. Numbers -201 and larger will be assigned for all other variations of a given model.

Tandem Style Models
Indicated by the digit representing the comp. model series connected in tandem with a comp. of the model series indicated by the first digit.

May be = (-) or A

Note: Nominal horsepower rating of tandem compressors is sum of individual compressor ratings

3DA3 - 060E - TFE 800

Compressor Family Series
Either a number or a letter established for each product family.

Displacement and Valve Plate
A letter only, arbitrarily assigned for each different displacement within any one family series.

Model Variation
A number or letter, assigned to indicate different model types within any family series.

May also be
"A" = (Alkylbenzene)
"E" = (POE Oil)
"L" = (Less Oil)

Compressor Motor Protection	
Description	Code
External inherent protection - one protector (line break) use with contactor	A
Internal inherent protection - one protector use with contactor	F
Internal thermostat(s); and ext, supplementary protector(s) use with contactor.	H
Internal thermostat(s); and three ext, supplementary protector(s) use with contactor.	L
Internal thermal protectors - electronic sensors; and control module external. Use with contactor.	S
Internal thermal protectors - electronic sensors; and control module external. use with contactor (For European use only).	W

* When applicable, specific 50 HZ ratings (Not necessarily identical to typical shown above) will be shown as alternate on 60 HZ rated models.

Electrical Codes					
60 Hz	50 Hz	Code	60 Hz	50 Hz	Code
115-1	100-1	A	-	220-1	S
230-1	200-1	B	-	200-1	T
5206-230-3	200/220-3	C	200-3	-	U
460-3	380/400-3	D	208-230-1	200-1	V
575-3	500-3	E	-	200/220-3	W
-	115-1	F	Misc. A.C. Ratings	X	
-	230-1	G	-	500-3	Y
208-1	200-1	H	-	220/240-1	Z
-	208/230-1	I	200-1	200-1	3
208/230/460-3	200/400-3	K	100-1	100-1	4
-	210/240/380-3	L	200-230-3	-	5
-	380-/420-3	M	230-3	-	6
230/460-3	200/400-3	N	380	346	7
-	200/380-3	P	200/220/380	200/345	8
-	200/240-3	R			

New Model Nomenclature (5th Digit = Application Rating)

R = Rating at +45°F to +130°F at 90°F Ambient Air

S = Rating at +20°F to +120°F at 90°F Ambient Air

F = Rating at -25°F to +105°F at 90° Ambient Air

3D – Semi-Hermetic Compressors

Compressor Cooling	
Code	Description
A	Air cooled
D	Discus
R	Refrigerant cooled
T	Std. two stage
W	Water cooled

Capacity Multiplier
M = 10,000
K = 1,000

May also be
 "O" = (Mineral Oil)
 "E" = (POE Oil)
 "L" = (Less Oil)

Compressor Motor Type	
Single Phase Motors	Code
Capacitor run - Capacitor start	C
Induction run - Capacitor start	I
Induction run - Split phase	S
Induction run - Capacitor start, low torque	X
Three Phase Motors	Code
General	T
3 Lead single voltage	
6 Lead part winding (575 volt)	
9 Lead dual voltage	
Star (wye) delta	E
6 Lead motors	F
Part winding or across the line	

Product Variations	
Numbers will be assigned as follows:	
1. Numbers - 001 through -199 are reserved for sub-b/m numbers.	
2. Numbers - 200 indicates a standard compressor and component parts b/m and model no.	
3. Numbers - 201 and larger will be assigned for all other variations of a given model.	
4. Numbers -C00 and larger will be assigned for all variations with CoreSense™ Modules Installed	

Primary Application Range
 R = ARI High Temp. Rated @ 45/130
 S = ARI Med Temp. Rated @ 20/120
 F = ARI Low Temp. Rated @ -25/105

Tandem Style Models
 Indicated by the digit representing the comp. model series connected in tandem with a comp. of the model series indicated by the first digit.

Nominal Capacity at Rating Condition 2
 numeric characters

3 DK3 R 15 ME - TFC 800

Compressor Motor Protection	
Description	Code
External inherent protection - one protector (line break) use with contactor	A
Internal inherent protection - one protector use with contactor	F
Internal thermostat(s); and ext, supplementary protector(s) use with contactor.	H
Internal thermostat(s); and three ext, supplementary protector(s) use with contactor.	L
Internal thermal protectors - electronic sensors; and control module external. Use with contactor.	S

* When applicable, specific 50 HZ ratings (Not necessarily identical to typical shown above) will be shown as alternate on 60 HZ rated models.

Electrical Codes			60 Hz			50 Hz		
60 Hz	50 Hz	Code	60 Hz	50 Hz	Code	60 Hz	50 Hz	Code
115-1	100-1	A	-	220-1	S	-	220-1	S
230-1	200-1	B	-	200-1	T	-	200-1	T
5206-230-3	200/220-3	C	200-3	-	U	208-230-1	200-1	V
460-3	380/400-3	D	-	200/220-3	W	-	200/220-3	W
575-3	500-3	E	-	115-1	F	Misc. A.C. Ratings	X	
-	230-1	G	-	230-1	Y	-	500-3	Y
208-1	200-1	H	-	220/240-1	Z	-	220/240-1	Z
-	208/230-1	I	200-1	200-1	3	200-1	200-1	3
208/230/460-3	200/400-3	K	100-1	100-1	4	100-1	100-1	4
-	210/240/380-3	L	200-230-3	-	5	200-230-3	-	5
-	380-/420-3	M	230-3	-	6	230-3	-	6
230/460-3	200/400-3	N	380	346	7	380	346	7
-	200/380-3	P	200/220/380	200/345	8	200/220/380	200/345	8
-	200/240-3	R						

Compressor Family Series
 Either a number or a letter established for each product family.

Displacement and Valve Plate
 A letter only, arbitrarily assigned for each different displacement within any one family series.

Model Variation
 A number or letter, assigned to indicate different model types within any family series.

New Model Nomenclature (5th Digit = Application Rating)
 R = Rating at +45°F to +130°F at 90°F Ambient Air
 S = Rating at +20°F to +120°F at 90°F Ambient Air
 F = Rating at -25°F to +105°F at 90° Ambient Air

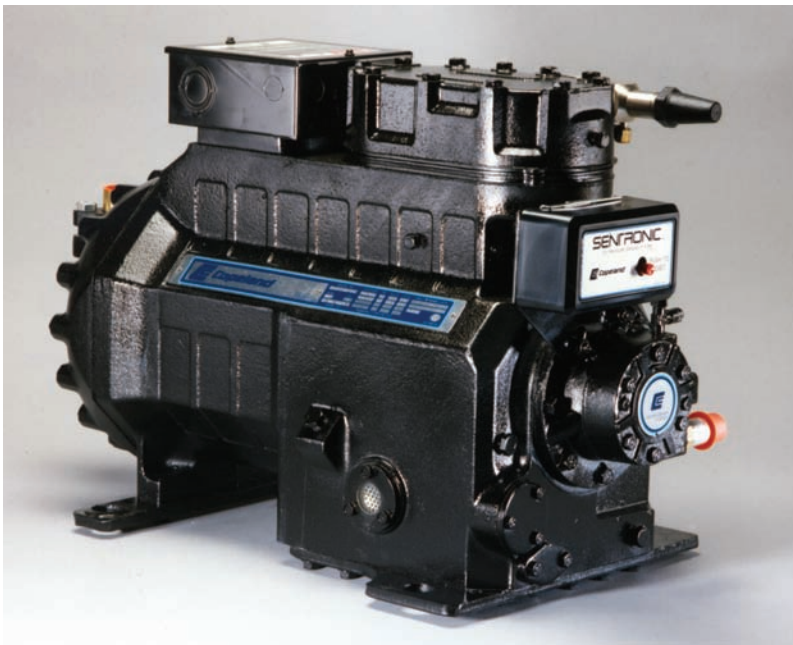

Common Replacement Parts

Common Parts	Part Number
Sight Glass Kit	998-0002-02
Sight Glass O-Ring	020-0844-05
Oil Check Valve Assembly	510-0142-00
Oil Screen Kit	998-0513-03
Oil Pump Kit	998-0008-33
Rotalock Adaptor Kit	998-0036-00
Gaskets	Part Number
Complete Gasket Set	998-1669-04
Housing Cover	020-0749-00
Stator Cover	020-0709-00
Bottom Plate	020-0479-00
Oil Pump	020-1204-00
Terminal Plate	020-0146-00
Rotalock Adaptor	020-0012-09
Cylinder Head - Standard/Moduload Models	020-0730-00
Cylinder Head - Digital Models	020-1368-00
CoreSense™ Parts	Part Number
CoreSense Module	943-0128-00
2D/3D CoreSense Wiring Harness	929-0097-00
CoreSense DLT Thermistor	985-0109-50
Current Sensor Kit	943-0064-00
CoreSense Terminal Box Kit	962-0437-00
Sensor Only	998-0162-01
Copper Gasket for Sensor	020-0297-13
O-Ring Gasket for Sensor	020-0003-28

Terminal Plate	Part Number
Terminal Fused Cluster (Fusite)	521-0018-00
Terminal Fused Seal (Fusite)	020-0844-02
T Block - used with Fusite electrical connector	021-0227-02
Terminal Board Assembly	580-0053-00
Demand Cooling (R22/R407A/C/F)	Part Number
120 Volt Demand Cooling Kit	998-1000-13
120 Volt Control Only	085-0110-00
240 Volt Demand Cooling Kit	998-1000-23
240 Volt Control Only	085-0110-01
Sentronic 3 Kits and Parts	Part Number
Complete Kit	585-1076-02
Sensor and Cable Kit	998-0162-00
Sensor Only	998-0162-01
Copper Gasket for Sensor	020-0297-13
O-Ring Gasket for Sensor	020-0003-28
Crankcase Heater	Part Number
120 Volt 100 Watt	518-0028-06
240 Volt 100 Watt	518-0028-07
Crankcase Heater Well	030-0187-01



3D – Semi-Hermetic Compressors

Parts for 3D Moduload Compressors

Moduload Unloaders	Part Number	Obsolete (Alco) Valve
Valve Less Coil	998-0326-00	
24 Volt Valve and Coil Kit	998-0326-01	
24 Volt Coil Only	023-0091-00	023-0039-09
120 Volt Valve and Coil Kit	998-0326-02	
120 Volt Coil Only	023-0091-01	023-0039-10
240 Volt Valve and Coil Kit	998-0326-03	
240 Volt Coil Only	023-0091-02	023-0039-11
Unloader Gasket	020-0783-00	
Spacer Plate	003-0616-01	
Spacer Plate Gasket	020-0727-00	
Top Plate	003-0754-00	
Top Plate Gasket	020-0726-00	

Cooling Fan Kits

Cooling Fan Kits	Part Number	Used On
120V w/Bottom Fan Guard	998-0550-05	All 3D
120V w/Complete Fan Guard	998-0550-02	
240V w/Bottom Fan Guard	998-0550-03	
240V w/Complete Fan Guard	998-0550-00	
460V w/Bottom Fan Guard	998-0550-04	
460V w/Complete Fan Guard	998-0550-01	
Fan Mounting Kit	998-0574-08	All Standard 3D
Fan Mounting Kit	998-0574-10	All Moduload/Digital
Fan Blade	083-0118-00	All 3D
Top Fan Guard	024-0200-00	

Service Valves

Part Number	Size	Discharge	Suction	Style	MTG Center	Thread
998-0510-02	1 1/8	X		Rotalock	Rotalock Valve Adaptor	1 3/4-12
998-0510-37		X		Rotalock		1 3/4-12
998-0510-11	1 3/8		X	Bolt on (2)	2 1/4 x 2 1/4	
998-0510-07	1 5/8		X	Bolt on (4)	2 1/2 x 2 1/2	
998-0510-08	1 3/8		X	Bolt on (4)	2 1/2 x 2 1/2	
998-0036-00		X		Rotalock Valve Adaptor	1 3/4-12	

Parts for 3D Digital Compressors

3D Digital	Part #
24V Coil	923-0084-00
120V Coil	923-0084-01
240V Coil	923-0084-02
Valve Only	910-0111-00
Unloader Gasket	020-1369-01
IDCM Control Module	943-0086-00
Discharge Thermistor	985-0109-07

3D Floating Reed Models - Compressor Parts

Model	Valve Plate Kit	Valve Plate Gasket	Motor Protector Kit	Terminal Plate Group
	(998-)	(920-)	(998-)	
3DA3-0500-TFC	1661-43	0729-05	0429-02	521-0144-00
3DA3-0500-TFD	1661-43	0729-05	0429-03	521-0144-00
3DA3-0500-TFE	1661-43	0729-05	0429-19	521-0144-00
3DA3-0600-TFC	1661-43	0729-05	0429-08	521-0144-00
3DA3-0600-TFD	1661-43	0729-05	0429-05	521-0144-00
3DA3-0600-TFE	1661-43	0729-05	0429-03	521-0144-00
3DA3-060E-TFC	1661-43	0729-05	0429-08	521-0144-00
3DA3-060E-TFD	1661-43	0729-05	0429-05	521-0144-00
3DA3-060E-TFE	1661-43	0729-05	0429-03	521-0144-00
3DA3-0750-TFC	1661-51	0729-05	0429-06	503-0390-00
3DA3-0750-TFD	1661-51	0729-05	0429-17	503-0390-00
3DA3-0750-TFE	1661-51	0729-05	0429-11	503-0390-00
3DA3-075E-TFC	1661-51	0729-05	0429-11	503-0390-00
3DA3-075E-TFD	1661-51	0729-05	0429-17	503-0390-00
3DA3-075E-TFE	1661-51	0729-05	0429-11	503-0390-00
3DB2-1000-TFC	1661-51	0729-01	0429-06	503-0390-00
3DB2-1000-TFD	1661-51	0729-01	0429-17	503-0390-00
3DB2-1000-TFE	1661-51	0729-01	0429-11	503-0390-00
3DB3-0500-TFC	1661-43	0729-01	0429-02	521-0144-00
3DB3-0500-TFD	1661-43	0729-01	0429-03	521-0144-00
3DB3-0500-TFE	1661-43	0729-01	0429-19	521-0144-00
3DB3-0750-FSM	1661-43	0729-01	0524-12	521-0169-00
3DB3-0750-TFC	1661-43	0729-01	0429-04	503-0390-00
3DB3-0750-TFD	1661-43	0729-01	0429-09	503-0390-00
3DB3-0750-TFE	1661-43	0729-01	0429-03	503-0390-00
3DB3-075E-TFC	1661-43	0729-01	0429-04	503-0390-00
3DB3-075E-TFD	1661-43	0729-01	0429-09	503-0390-00
3DB3-075E-TFE	1661-43	0729-01	0429-03	503-0390-00
3DB3-1000-TFC	1661-51	0729-01	0429-06	503-0390-00
3DB3-1000-TFD	1661-51	0729-01	0429-17	503-0390-00
3DB3-1000-TFE	1661-51	0729-01	0429-11	503-0390-00
3DB3-100E-TFC	1661-51	0729-01	0429-06	503-0390-00
3DB3-100E-TFD	1661-51	0729-01	0429-17	503-0390-00
3DB3-100E-TFE	1661-51	0729-01	0429-11	503-0390-00
• 3DE3-0500-TFC	1661-64	0729-05	0429-02	521-0144-00
• 3DE3-0500-TFD	1661-64	0729-05	0429-03	521-0144-00
• 3DE3-0500-TFE	1661-64	0729-05	0429-19	521-0144-00
• 3DE3-0750-TFC	1661-53	0729-05	0429-06	503-0390-00
• 3DE3-0750-TFD	1661-53	0729-05	0429-17	503-0390-00
• 3DE3-0750-TFE	1661-53	0729-05	0429-11	503-0390-00
• 3DE3-075E-TFC	1661-53	0729-05	0429-06	503-0390-00
• 3DE3-075E-TFD	1661-53	0729-05	0429-17	503-0390-00

• = Moduload

3D – Semi-Hermetic Compressors

3D Floating Reed Models - Compressor Parts

Model	Valve Plate Kit	Valve Plate Gasket	Motor Protector Kit	Terminal Plate Group
	(998-)	(920-)	(998-)	
• 3DE3-075E-TFE	1661-53	0729-05	0429-11	503-0390-00
3DEH-075E-TFC	1661-48	0729-05	0429-06	503-0390-00
3DEH-075E-TFD	1661-48	0729-05	0429-17	503-0390-00
3DEH-075E-TFE	1661-48	0729-05	0429-11	503-0390-00
3DF3-0750-TFC	1661-43	0729-03	0429-04	521-0144-00
3DF3-0750-TFD	1661-43	0729-03	0429-09	521-0144-00
3DF3-0900-TFC	1661-43	0729-03	0429-00	503-0390-00
3DF3-0900-TFD	1661-43	0729-03	0429-09	503-0390-00
3DF3-0900-TFE	1661-43	0729-03	0429-11	503-0390-00
3DF3-090E-TFC	1661-43	0729-03	0429-00	503-0390-00
3DF3-090E-TFD	1661-43	0729-03	0429-09	503-0390-00
3DF3-090E-TFE	1661-43	0729-03	0429-11	503-0390-00
3DF3-1200-TFC	1661-43	0729-03	0451-02	503-0390-00
3DF3-1200-TFD	1661-43	0729-03	0455-03	503-0390-00
3DF3-1200-TFE	1661-43	0729-03	0455-04	503-0390-00
3DF3-120E-TFC	1661-43	0729-03	0451-02	503-0390-00
3DF3-120E-TFD	1661-43	0729-03	0455-03	503-0390-00
3DF4-120E-TFC	1661-43	0729-03	0451-02	503-0390-00
3DF4-120E-TFD	1661-43	0729-03	0455-03	503-0390-00
• 3DG3-0900-TFC	1661-57	0729-03	0429-00	503-0390-00
• 3DG3-0900-TFD	1661-57	0729-03	0429-09	503-0390-00
• 3DG3-0900-TFE	1661-57	0729-03	0429-11	503-0390-00
• 3DG3-090E-TFC	1661-57	0729-03	0429-00	503-0390-00
• 3DG3-090E-TFD	1661-57	0729-03	0429-09	503-0390-00
• 3DG3-090E-TFE	1661-57	0729-03	0429-11	503-0390-00
• 3DGH-090E-TFC	1661-45	0729-03	0429-00	503-0390-00
• 3DGH-090E-TFD	1661-45	0729-03	0429-09	503-0390-00
• 3DGH-090E-TFE	1661-45	0729-03	0429-11	503-0390-00
• 3DH3-0600-TFC	1661-54	0729-05	0429-08	521-0144-00
• 3DH3-0600-TFD	1661-54	0729-05	0429-05	521-0144-00
• 3DH3-0600-TFE	1661-54	0729-05	0429-03	521-0144-00
• 3DH3-060E-TFC	1661-54	0729-05	0429-08	521-0144-00
• 3DH3-060E-TFD	1661-54	0729-05	0429-05	521-0144-00
• 3DH3-060E-TFE	1661-54	0729-05	0429-03	521-0144-00
• 3DHH-060E-TFC	1661-46	0729-05	0429-08	521-0144-00
• 3DHH-060E-TFD	1661-46	0729-05	0429-05	521-0144-00
• 3DHH-060E-TFE	1661-46	0729-05	0429-03	521-0144-00
• 3DJ3-0750-TFC	1661-54	0729-01	0429-04	521-0144-00
• 3DJ3-0750-TFD	1661-54	0729-01	0429-09	521-0144-00

• = Moduload

3D Floating Reed Models - Compressor Parts

Model	Valve Plate Kit	Valve Plate Gasket	Motor Protector Kit	Terminal Plate Group
	(998-)	(920-)	(998-)	
• 3DJ3-0750-TFE	1661-54	0729-01	0429-03	521-0144-00
• 3DJ3-075E-TFC	1661-54	0729-01	0429-04	521-0144-00
• 3DJ3-075E-TFD	1661-54	0729-01	0429-09	521-0144-00
• 3DJ3-075E-TFE	1661-54	0729-01	0429-03	521-0144-00
• 3DJH-075E-TFC	1661-46	0729-01	0429-04	521-0144-00
• 3DJH-075E-TFD	1661-46	0729-01	0429-09	521-0144-00
• 3DJH-075E-TFE	1661-46	0729-01	0429-03	521-0144-00
• 3DK3-0750-TFC	1661-56	0729-03	0429-04	521-0144-00
• 3DK3-0750-TFD	1661-56	0729-03	0429-09	521-0144-00
• 3DK3-0900-TFC	1661-56	0729-03	0429-00	503-0390-00
• 3DK3-0900-TFD	1661-56	0729-03	0429-09	503-0390-00
• 3DK3-0900-TFE	1661-56	0729-03	0429-11	503-0390-00
• 3DK3-1200-TFC	1661-56	0729-03	0451-02	503-0390-00
• 3DK3-1200-TFD	1661-56	0729-03	0455-03	503-0390-00
• 3DK3-120E-TFC	1661-56	0729-03	0451-02	503-0390-00
• 3DK3-120E-TFD	1661-56	0729-03	0455-03	503-0390-00
• 3DK4-1200-TFD	1661-56	0729-03	0455-03	503-0390-00
• 3DK8-0750-TFC	1661-56	0729-03	0429-04	521-0144-00
• 3DK8-0750-TFD	1661-56	0729-03	0429-09	521-0144-00
• 3DK8-075E-TFD	1661-56	0729-03	0429-09	521-0144-00
• 3DKB-0750-TFC	1661-56	0729-03	0429-04	521-0144-00
• 3DKB-0750-TFD	1661-56	0729-03	0429-09	521-0144-00
• 3DKH-120E-TFC	1661-44	0729-03	0451-02	503-0390-00
• 3DKH-120E-TFD	1661-44	0729-03	0455-03	503-0390-00
• 3DP3-0500-FSM	1661-55	0729-01	0524-12	521-0169-00
• 3DP3-0500-TFC	1661-55	0729-01	0429-02	521-0144-00
• 3DP3-0500-TFD	1661-55	0729-01	0429-03	521-0144-00
• 3DP3-0500-TFE	1661-55	0729-01	0429-19	521-0144-00
• 3DP3-0750-TFC	1661-55	0729-01	0429-04	521-0144-00
• 3DP3-0750-TFD	1661-55	0729-01	0429-09	521-0144-00
• 3DP3-0750-TFE	1661-55	0729-01	0429-03	521-0144-00
• 3DP3-075E-TFD	1661-55	0729-01	0429-09	521-0144-00
• 3DP3-1000-TFC	1661-55	0729-01	0429-06	503-0390-00
• 3DP3-1000-TFD	1661-55	0729-01	0429-17	503-0390-00
• 3DP3-1000-TFE	1661-55	0729-01	0429-11	503-0390-00
• 3DP3-100E-TFC	1661-55	0729-01	0429-06	503-0390-00
• 3DP3-100E-TFD	1661-55	0729-01	0429-17	503-0390-00
• 3DP3-100E-TFE	1661-55	0729-01	0429-11	503-0390-00
• 3DPH-100E-TFC	1661-47	0729-01	0429-06	503-0390-00

• = Moduload

3D – Semi-Hermetic Compressors

3D Floating Reed Models - Compressor Parts

Model	Valve Plate Kit	Valve Plate Gasket	Motor Protector Kit	Terminal Plate Group
	(998-)	(920-)	(998-)	
• 3DPH-100E-TFD	1661-47	0729-01	0429-17	503-0390-00
• 3DPH-100E-TFE	1661-47	0729-01	0429-11	503-0390-00
• 3DR3-1000-TFC	1661-57	0729-07	0429-00	503-0390-00
• 3DR3-1000-TFD	1661-57	0729-07	0429-09	503-0390-00
• 3DR3-1000-TFE	1661-57	0729-07	0429-11	503-0390-00
• 3DR3-100E-TFC	1661-57	0729-07	0429-00	503-0390-00
• 3DR3-100E-TFD	1661-57	0729-07	0429-09	503-0390-00
• 3DR3-100E-TFE	1661-57	0729-07	0429-11	503-0390-00
• 3DRH-100E-TFC	1661-45	0729-07	0429-00	503-0390-00
• 3DRH-100E-TFD	1661-45	0729-07	0429-09	503-0390-00
• 3DRH-100E-TFE	1661-45	0729-07	0429-11	503-0390-00
3DS3-0750-TFC	1661-43	0729-07	0429-04	521-0144-00
3DS3-0750-TFD	1661-43	0729-07	0429-09	521-0144-00
3DS3-0750-TFE	1661-43	0729-07	0429-03	521-0144-00
3DS3-1000-TFC	1661-43	0729-07	0429-00	503-0390-00
3DS3-1000-TFD	1661-43	0729-07	0429-09	503-0390-00
3DS3-1000-TFE	1661-43	0729-07	0429-11	503-0390-00
3DS3-100E-TFC	1661-43	0729-07	0429-00	503-0390-00
3DS3-100E-TFD	1661-43	0729-07	0429-09	503-0390-00
3DS3-100E-TFE	1661-43	0729-07	0429-11	503-0390-00

• = Moduload

3D Delta Reed Models - Compressor Parts

Model (Horse Power Nomenclature)	Model (BTU Nomenclature)	Valve Plate Kit	Valve Plate Gasket	Motor Protector Kit	Terminal Plate Group
		(998-)	(920-)	(998-)	
3DA3A0500-TFC	3DA3F18K0-TFC	2661-43	0981-02	0429-02	521-0144-00
3DA3A0500-TFD	3DA3F18K0-TFD	2661-43	0981-02	0429-03	521-0144-00
3DA3A0500-TFE	3DA3F18K0-TFE	2661-43	0981-02	0429-19	521-0144-00
3DA3A0600-TFC	3DA3F28K0-TFC	2661-43	0981-02	0429-08	521-0144-00
3DA3A0600-TFD	3DA3F28K0-TFD	2661-43	0981-02	0429-05	521-0144-00
3DA3A0600-TFE	3DA3F28K0-TFE	2661-43	0981-02	0429-03	521-0144-00
3DA3A060E-TFC	3DA3F28KE-TFC	2661-43	0981-02	0429-08	521-0144-00
3DA3A060E-TFD	3DA3F28KE-TFD	2661-43	0981-02	0429-05	521-0144-00
3DA3A060E-TFE	3DA3F28KE-TFE	2661-43	0981-02	0429-03	521-0144-00
3DA3A0750-TFC	3DA3R10M0-TFC	2661-51	0981-02	0429-06	503-0390-00
3DA3A0750-TFD	3DA3R10M0-TFD	2661-51	0981-02	0429-17	503-0390-00
3DA3A0750-TFE	3DA3R10M0-TFE	2661-51	0981-02	0429-11	503-0390-00
3DA3A075E-TFC	3DA3R10ME-TFC	2661-51	0981-02	0429-06	503-0390-00
3DA3A075E-TFD	3DA3R10ME-TFD	2661-51	0981-02	0429-17	503-0390-00
3DA3A075E-TFE	3DA3R10ME-TFE	2661-51	0981-02	0429-11	503-0390-00
3DB3A0500-TFC	3DB3F22K0-TFC	2661-43	0981-00	0429-02	521-0144-00
3DB3A0500-TFD	3DB3F22K0-TFD	2661-43	0981-00	0429-03	521-0144-00
3DB3A0500-TFE	3DB3F22K0-TFE	2661-43	0981-00	0429-19	521-0144-00
3DB3A0750-TFC	3DB3F33K0-TFC	2661-43	0981-00	0429-04	521-0144-00
3DB3A0750-TFD	3DB3F33K0-TFD	2661-43	0981-00	0429-09	521-0144-00
3DB3A0750-TFE	3DB3F33K0-TFE	2661-43	0981-00	0429-03	521-0144-00
3DB3A075E-TFC	3DB3F33KE-TFC	2661-43	0981-00	0429-04	521-0144-00
3DB3A075E-TFD	3DB3F33KE-TFD	2661-43	0981-00	0429-09	521-0144-00
3DB3A075E-TFE	3DB3F33KE-TFE	2661-43	0981-00	0429-03	521-0144-00
3DB3A1000-TFC	3DB3R12M0-TFC	2661-51	0981-00	0429-06	503-0390-00
3DB3A1000-TFD	3DB3R12M0-TFD	2661-51	0981-00	0429-17	503-0390-00
3DB3A1000-TFE	3DB3R12M0-TFE	2661-51	0981-00	0429-11	503-0390-00
3DB3A100E-TFC	3DB3R12ME-TFC	2661-51	0981-00	0429-06	503-0390-00
3DB3A100E-TFD	3DB3R12ME-TFD	2661-51	0981-00	0429-17	503-0390-00
3DB3A100E-TFE	3DB3R12ME-TFE	2661-51	0981-00	0429-11	503-0390-00
• 3DE3A0500-TFC	3DE3R70K0-TFC	2661-64	0981-02	0429-02	521-0144-00
• 3DE3A0500-TFD	3DE3R70K0-TFD	2661-64	0981-02	0429-03	521-0144-00
• 3DE3A0500-TFE	3DE3R70K0-TFE	2661-64	0981-02	0429-19	521-0144-00
• 3DE3A0750-TFC	3DE3R10M0-TFC	2661-53	0981-02	0429-06	503-0390-00
• 3DE3A0750-TFD	3DE3R10M0-TFD	2661-53	0981-02	0429-17	503-0390-00
• 3DE3A0750-TFE	3DE3R10M0-TFE	2661-53	0981-02	0429-11	503-0390-00
• 3DE3A075E-TFC	3DE3R10ME-TFC	2661-53	0981-02	0429-06	503-0390-00
• 3DE3A075E-TFD	3DE3R10ME-TFD	2661-53	0981-02	0429-17	503-0390-00
• 3DE3A075E-TFE	3DE3R10ME-TFE	2661-53	0981-02	0429-11	503-0390-00
• 3DEHA075E-TFC	3DEHR10ME-TFC	2661-48	0981-02	0429-06	503-0390-00

• = Moduload

3D – Semi-Hermetic Compressors

3D Delta Reed Models - Compressor Parts

Model (Horse Power Nomenclature)	Model (BTU Nomenclature)	Valve Plate Kit	Valve Plate Gasket	Motor Protector Kit	Terminal Plate Group
		(998-)	(920-)	(998-)	
• 3DEHA075E-TFD	3DEHR10ME-TFD	2661-48	0981-02	0429-17	503-0390-00
• 3DEHA075E-TFE	3DEHR10ME-TFE	2661-48	0981-02	0429-11	503-0390-00
3DF3A0750-TFC	3DF3F26K0-TFC	2661-43	0981-01	0429-04	521-0144-00
3DF3A0750-TFD	3DF3F26K0-TFD	2661-43	0981-01	0429-09	521-0144-00
3DF3A0900-TFC	3DF3F40K0-TFC	2661-43	0981-01	0429-00	503-0390-00
3DF3A0900-TFD	3DF3F40K0-TFD	2661-43	0981-01	0429-09	503-0390-00
3DF3A0900-TFE	3DF3F40K0-TFE	2661-43	0981-01	0429-11	503-0390-00
3DF3A090E-TFC	3DF3F40KE-TFC	2661-43	0981-01	0429-00	503-0390-00
3DF3A090E-TFD	3DF3F40KE-TFD	2661-43	0981-01	0429-09	503-0390-00
3DF3A090E-TFE	3DF3F40KE-TFE	2661-43	0981-01	0429-11	503-0390-00
3DF3A1200-TFC	3DF3R15M0-TFC	2661-43	0981-01	0451-02	503-0390-00
3DF3A1200-TFD	3DF3R15M0-TFD	2661-43	0981-01	0455-03	503-0390-00
3DF3A120E-TFC	3DF3R15ME-TFC	2661-43	0981-01	0451-02	503-0390-00
3DF3A120E-TFD	3DF3R15ME-TFD	2661-43	0981-01	0455-03	503-0390-00
• 3DG3A0900-TFC	3DG3F40K0-TFC	2661-57	0981-01	0429-00	503-0390-00
• 3DG3A0900-TFE	3DG3F40K0-TFE	2661-57	0981-01	0429-11	503-0390-00
• 3DG3A090E-TFC	3DG3F40KE-TFC	2661-57	0981-01	0429-00	503-0390-00
• 3DG3A090E-TFD	3DG3F40KE-TFD	2661-57	0981-01	0429-09	503-0390-00
• 3DG3A090E-TFE	3DG3F40KE-TFE	2661-57	0981-01	0429-11	503-0390-00
• 3DGHA090E-TFC	3DGHF40KE-TFC	2661-45	0981-01	0429-00	503-0390-00
• 3DGHA090E-TFD	3DGHF40KE-TFD	2661-45	0981-01	0429-09	503-0390-00
• 3DGHA090E-TFE	3DGHF40KE-TFC	2661-45	0981-01	0429-11	503-0390-00
• 3DH3A0600-TFC	3DH3F28K0-TFC	2661-54	0981-02	0429-08	521-0144-00
• 3DH3A0600-TFD	3DH3F28K0-TFD	2661-54	0981-02	0429-05	521-0144-00
• 3DH3A0600-TFE	3DH3F28K0-TFE	2661-54	0981-02	0429-03	521-0144-00
• 3DH3A060E-TFC	3DH3F28KE-TFC	2661-54	0981-02	0429-08	521-0144-00
• 3DH3A060E-TFD	3DH3F28KE-TFD	2661-54	0981-02	0429-05	521-0144-00
• 3DH3A060E-TFE	3DH3F28KE-TFE	2661-54	0981-02	0429-03	521-0144-00
• 3DHHA060E-TFC	3DHHF28KE-TFC	2661-46	0981-02	0429-08	521-0144-00
• 3DHHA060E-TFD	3DHHF28KE-TFD	2661-46	0981-02	0429-05	521-0144-00
• 3DHHA060E-TFE	3DHHF28KE-TFE	2661-46	0981-02	0429-03	521-0144-00
• 3DJ3A0750-TFC	3DJ3F33K0-TFC	2661-54	0981-00	0429-04	521-0144-00
• 3DJ3A0750-TFD	3DJ3F33K0-TFD	2661-54	0981-00	0429-09	521-0144-00
• 3DJ3A0750-TFE	3DJ3F33K0-TFE	2661-54	0981-00	0429-03	521-0144-00
• 3DJ3A075E-TFC	3DJ3F33KE-TFC	2661-54	0981-00	0429-04	521-0144-00
• 3DJ3A075E-TFD	3DJ3F33KE-TFD	2661-54	0981-00	0429-09	521-0144-00
• 3DJ3A075E-TFE	3DJ3F33KE-TFE	2661-54	0981-00	0429-03	521-0144-00
• 3DJHA075E-TFC	3DJHF33KE-TFC	2661-46	0981-00	0429-04	521-0144-00
• 3DJHA075E-TFD	3DJHF33KE-TFD	2661-46	0981-00	0429-09	521-0144-00
• 3DJHA075E-TFE	3DJHF33KE-TFE	2661-46	0981-00	0429-03	521-0144-00

• = Moduload

3D Delta Reed Models - Compressor Parts

Model (Horse Power Nomenclature)	Model (BTU Nomenclature)	Valve Plate Kit	Valve Plate Gasket	Motor Protector Kit	Terminal Plate Group
		(998-)	(920-)	(998-)	
• 3DK3A0750-TFC	N/A	2661-56	0981-01	0429-04	521-0144-00
• 3DK3A0750-TFD	N/A	2661-56	0981-01	0429-09	521-0144-00
• 3DK3A0900-TFC	N/A	2661-56	0981-01	0429-00	503-0390-00
• 3DK3A0900-TFD	N/A	2661-56	0981-01	0429-09	503-0390-00
• 3DK3A0900-TFE	N/A	2661-56	0981-01	0429-11	503-0390-00
• 3DK3A1200-TFC	3DK3R15M0-TFC	2661-56	0981-01	0451-02	503-0390-00
• 3DK3A1200-TFD	3DK3R15M0-TFD	2661-56	0981-01	0455-03	503-0390-00
• 3DK3A120E-TFC	3DK3R15ME-TFC	2661-56	0981-01	0451-02	503-0390-00
• 3DK3A120E-TFD	3DK3R15ME-TFD	2661-56	0981-01	0455-03	503-0390-00
• 3DKHA120E-TFC	3DKHR15ME-TFC	2661-44	0981-01	0451-02	503-0390-00
• 3DKHA120E-TFD	3DKHR15ME-TFD	2661-44	0981-01	0455-03	503-0390-00
• 3DP3A0500-TFC	N/A	2661-55	0981-00	0429-02	521-0144-00
• 3DP3A0500-TFD	N/A	2661-55	0981-00	0429-03	521-0144-00
• 3DP3A0500-TFE	N/A	2661-55	0981-00	0429-19	521-0144-00
• 3DP3A0750-TFC	N/A	2661-55	0981-00	0429-04	521-0144-00
• 3DP3A0750-TFD	N/A	2661-55	0981-00	0429-09	521-0144-00
• 3DP3A0750-TFE	N/A	2661-55	0981-00	0429-03	521-0144-00
• 3DP3A075E-TFD	N/A	2661-55	0981-00	0429-09	521-0144-00
• 3DP3A1000-TFC	3DP3R12M0-TFC	2661-55	0981-00	0429-06	503-0390-00
• 3DP3A1000-TFD	3DP3R12M0-TFD	2661-55	0981-00	0429-17	503-0390-00
• 3DP3A1000-TFE	3DP3R12M0-TFE	2661-55	0981-00	0429-11	503-0390-00
• 3DP3A100E-TFC	3DP3R12ME-TFC	2661-55	0981-00	0429-06	503-0390-00
• 3DP3A100E-TFD	3DP3R12ME-TFD	2661-55	0981-00	0429-17	503-0390-00
• 3DP3A100E-TFE	3DP3R12ME-TFE	2661-55	0981-00	0429-11	503-0390-00
• 3DPHA100E-TFC	3DPHR12ME-TFC	2661-47	0981-00	0429-06	503-0390-00
• 3DPHA100E-TFD	3DPHR12M3-TFD	2661-47	0981-00	0429-17	503-0390-00
• 3DPHA100E-TFE	3DPHR12ME-TFE	2661-47	0981-00	0429-11	503-0390-00
• 3DR3A1000-TFC	3DR3F46K0-TFC	2661-57	0981-03	0429-00	503-0390-00
• 3DR3A1000-TFD	3DR3F46K0-TFD	2661-57	0981-03	0429-09	503-0390-00
• 3DR3A1000-TFE	3DR3F46K0-TFE	2661-57	0981-03	0429-11	503-0390-00
• 3DRHA100E-TFC	3DRHF46KE-TFC	2661-45	0981-03	0429-00	503-0390-00
• 3DRHA100E-TFD	3DRHF46KE-TFD	2661-45	0981-03	0429-09	503-0390-00
• 3DRHA100E-TFE	3DRHF46KE-TFE	2661-45	0981-03	0429-11	503-0390-00
3DS3A0750-TFC	3DS3F30K0-TFC	2661-43	0981-03	0429-04	521-0144-00
3DS3A0750-TFD	3DS3F30K0-TFD	2661-43	0981-03	0429-09	521-0144-00
3DS3A0750-TFE	3DS3F30K0-TFE	2661-43	0981-03	0429-03	521-0144-00
3DS3A1000-TFC	3DS3F46K0-TFC	2661-43	0981-03	0429-00	503-0390-00
3DS3A1000-TFD	3DS3F46K0-TFD	2661-43	0981-03	0429-09	503-0390-00
3DS3A1000-TFE	3DS3F46K0-TFE	2661-43	0981-03	0429-11	503-0390-00
3DS3A100E-TFC	3DS3F46KE-TFC	2661-43	0981-03	0429-00	503-0390-00

• = Moduload

3D – Semi-Hermetic Compressors

3D Delta Reed Models - Compressor Parts

Model (Horse Power Nomenclature)	Model (BTU Nomenclature)	Valve Plate Kit	Valve Plate Gasket	Motor Protector Kit	Terminal Plate Group
		(998-)	(920-)	(998-)	
3DS3A100E-TFD	3DS3F46KE-TFD	2661-43	0981-03	0429-09	503-0390-00
3DS3A100E-TFE	3DS3F46KE-TFE	2661-43	0981-03	0429-11	503-0390-00
3DS3A1500-TFC	3DS3R17M0-TFC	2661-51	0981-03	0504-04	503-0390-00
3DS3A1500-TFD	3DS3R17M0-TFD	2661-51	0981-03	0504-00	503-0390-00
3DS3A1500-TFE	3DS3R17M0-TFE	2661-51	0981-03	0504-01	503-0390-00
3DS3A150E-TFC	3DS3R17ME-TFC	2661-51	0981-03	0504-04	503-0390-00
3DS3A150E-TFD	3DS3R17ME-TFD	2661-51	0981-03	0504-00	503-0390-00
3DS3A150E-TFE	3DS3R17ME-TFE	2661-51	0981-03	0504-01	503-0390-00
• 3DT3A0750-TFC	3DT3R11M0-TFC	2661-56	0981-03	0429-04	521-0144-00
• 3DT3A0750-TFD	3DT3R11M0-TFD	2661-56	0981-03	0429-09	521-0144-00
• 3DT3A0750-TFE	3DT3R11M0-TFE	2661-56	0981-03	0429-03	521-0144-00
• 3DT3A1000-TFC	3DT3R11M0-TFC	2661-56	0981-03	0429-00	503-0390-00
• 3DT3A1000-TFD	3DT3R11M0-TFD	2661-56	0981-03	0429-09	503-0390-00
• 3DT3A1000-TFE	3DT3R11M0-TFE	2661-56	0981-03	0429-11	503-0390-00
• 3DT3A1500-TFC	3DT3R17M0-TFC	2661-56	0981-03	0504-04	503-0390-00
• 3DT3A1500-TFD	3DT3R17M0-TFD	2661-56	0981-03	0504-00	503-0390-00
• 3DT3A1500-TFE	3DT3R17M0-TFE	2661-56	0981-03	0504-01	503-0390-00
• 3DT3A150E-TFC	3DT3R17ME-TFC	2661-56	0981-03	0504-04	503-0390-00
• 3DT3A150E-TFD	3DT3R17ME-TFD	2661-56	0981-03	0504-00	503-0390-00
• 3DT3A150E-TFE	3DT3R17ME-TFE	2661-56	0981-03	0504-01	503-0390-00
• 3DTHA150E-TFC	3DTHR17ME-TFC	2661-44	0981-03	0504-04	503-0390-00
• 3DTHA150E-TFD	3DTHR17ME-TFD	2661-44	0981-03	0504-00	503-0390-00
• 3DTHA150E-TFE	3DTHR17ME-TFE	2661-44	0981-03	0504-01	503-0390-00

• = Moduload

3D Digital Models - Compressor Parts

Digital Model	Standard Model	Valve Plate Kit	Valve Plate Gasket	Terminal Plate Group	Motor Protector Kit
		(998-)	(920-)		(998-)
3DADF28KE-TFC	3DA3F28KE-TFC	6661-31	0981-02	503-0346-01	0429-05
3DADF28KE-TFD	3DA3F28KE-TFD	6661-31	0981-02	503-0346-01	0429-05
3DADF28KE-TFE	3DA3F28KE-TFE	6661-31	0981-02	503-0346-01	0429-05
3DADR10ME-TFE	3DA3R10ME-TFE	6661-30	0981-02	503-0804-00	0429-11
3DBDF33KE-TFC	3DB3F33KE-TFC	6661-31	0981-02	503-0346-01	0429-04
3DBDF33KE-TFD	3DB3F33KE-TFD	6661-31	0981-02	503-0346-01	0429-09
3DBDF33KE-TFE	3DB3F33KE-TFE	6661-31	0981-02	503-0346-01	0429-03
3DBDR12ME-TFC	3DB3R12ME-TFC	6661-30	0981-02	503-0804-00	0429-06
3DBDR12ME-TFD	3DB3R12ME-TFD	6661-30	0981-02	503-0804-00	0429-17
3DBDR12ME-TFE	3DB3R12ME-TFE	6661-30	0981-02	503-0804-00	0429-11
3DFDF40KE-TFC	3DF3F40KE-TFC	6661-31	0981-02	503-0804-00	0429-00
3DFDF40KE-TFD	3DF3F40KE-TFD	6661-31	0981-02	503-0804-00	0429-09
3DFDF40KE-TFE	3DF3F40KE-TFE	6661-31	0981-02	503-0804-00	0429-11
3DFDR15ME-TFC	3DF3R15ME-TFC	6661-30	0981-02	503-0804-00	0451-02
3DFDR15ME-TFD	3DF3R15ME-TFD	6661-30	0981-02	503-0804-00	0455-03
3DSDF46KE-TFC	3DS3F46KE-TFC	6661-31	0981-02	503-0804-00	0429-00
3DSDF46KE-TFD	3DS3F46KE-TFD	6661-31	0981-03	503-0804-00	0429-09
3DSDF46KE-TFE	3DS3F46KE-TFE	6661-31	0981-03	503-0804-00	0429-11
3SDSR17ME-TFC	3DS3R17ME-TFC	6661-30	0981-03	503-0804-00	0451-01
3SDSR17ME-TFD	3DS3R17ME-TFD	6661-30	0981-03	503-0804-00	0455-00
3SDSR17ME-TFE	3DS3R17ME-TFE	6661-30	0981-03	503-0804-00	0455-02



3D – Semi-Hermetic Compressors

3D Compressor Capacity Control Kits

Standard Model	Moduload Capacity Control Model for HFC Refrigerant	Moduload Conversion Kit for HFC Refrigerant	Moduload Capacity Control Model for CFC Refrigerant	Moduload Conversion Kit for CFC Refrigerant
3DA3F28KE	3DHHF28KE	998-2017-42	3DH3F28K0	998-2017-47
3DA3R10ME	3DEHR10ME	998-2017-44	3DE3R10M0	998-2017-49
3DB3F33KE	3DJHF33KE	998-2017-42	3DJ3F33K0	998-2017-47
3DB3R12ME	3DPHR12ME	998-2017-43	3DP3R12M0	998-2017-48
3DF3F40KE	3DGHF40KE	998-2017-41	3DG3F40K0	998-2017-46
3DF3R15ME	3DKHR15ME	998-2017-40	3DK3R15M0	998-2017-45
3DS3F46KE	3DRHF46KE	998-2017-41	3DR3F46K0	998-2017-46
3DS3R17ME	3DTHR17ME	998-2017-40	3DT3R17M0	998-2017-45

NOTE: Capacity Control Kits listed above do not include Unloader Solenoid Valves

Moduload Unloader Solenoid Valve Kits

Valve Less Coil	With 24V Coil	With 120V Coil	With 240V Coil
998-0326-00	998-0326-01	998-0326-02	998-0326-03

Digital Conversion Kits

Standard Model	Digital Model	Digital Conversion Kit
3DA3F28KE	3DADF28KE	980-3000-01
3DA3R10ME	3DADR10ME	980-3000-00
3DB3F33KE	3DBDF33KE	980-3000-01
3DB3R12ME	3DBDR12ME	980-3000-00
3DF3F40KE	3DFDF40KE	980-3000-01
3DF3R15ME	3DFDR15ME	980-3000-00
3DS3F46KE	3DSDF46KE	980-3000-01
3DS3R17ME	3DSDR17ME	980-3000-00



Digital Unloader Solenoid Valve Kits

Valve Less Coil	24V Coil Only	120V Coil Only	240V Coil Only
910-0111-00	923-0084-00	923-0084-01	923-0084-02

Semi-Hermetic Compressors – 4D and 4R

Compressor Cooling	
Code	Description
A	Air cooled
D	Discus
R	Refrigerant cooled
T	Std. two stage
W	Water cooled

Comp. Motor Rating Nominal					
HP	Code	HP	Code	HP	Code
1/4	0025	2-3/4	0275	15	1500
1/3	0033	3 (0310)	0300	20	2000
1/2	0050	3-1/2	0350	25	2500
3/4	0075	4 (0406)	0400	30	3000
1	0100	5 (0506)	0500	35	3500
1-1/4	0125	6	0600	40	4000
1-1/2	0150	7-1/2 (0766)	0750	50	5000
1-3/4	0175	9	0900	60	6000
2	0200	10 (1015)	1000		
2-1/2	0250	12	1200		

Compressor Motor Type	
Single Phase Motors	Code
Capacitor run - Capacitor start	C
Induction run - Capacitor start	I
Induction run - Split phase	S
Induction run - Capacitor start, low torque	X
Three Phase Motors	Code
General	T
3 Lead single voltage	
6 Lead part winding (575 volt)	
9 Lead dual voltage	
Star (wye) delta	E
6 Lead motors	F
Part winding or across the line	

Product Variations
Numbers will be assigned as follows:

- Numbers -001 through -199 are reserved for sub-b/m numbers.
- Numbers -200 indicates a standard compressor and component parts b/m and model no.
- Numbers -201 and larger will be assigned for all other variations of a given model.

Tandem Style Models
Indicated by the digit representing the comp. model series connected in tandem with a comp. of the model series indicated by the first digit.

May be = (-) or A
Note: Nominal horsepower rating of tandem compressors is sum of individual compressor ratings

4DA3 - 100E - TSK 800

Compressor Family Series
Either a number or a letter established for each product family.

Displacement and Valve Plate
A letter only, arbitrarily assigned for each different displacement within any one family series.

Model Variation
A number or letter, assigned to indicate different model types within any family series.

May also be
"A" = (Alkylbenzene)
"E" = (POE Oil)
"L" = (Less Oil)

Compressor Motor Protection	
Description	Code
External inherent protection - one protector (line break) use with contactor	A
Internal inherent protection - one protector use with contactor	F
Internal thermostat(s); and ext, supplementary protector(s) use with contactor.	H
Internal thermostat(s); and three ext, supplementary protector(s) use with contactor.	L
Internal thermal protectors - electronic sensors; and control module external. Use with contactor.	S
Internal thermal protectors - electronic sensors; and control module external. use with contactor (For European use only).	W

Electrical Codes					
60 Hz	50 Hz	Code	60 Hz	50 Hz	Code
115-1	100-1	A	-	220-1	S
230-1	200-1	B	-	200-1	T
5206-230-3	200/220-3	C	200-3	-	U
460-3	380/400-3	D	208-230-1	200-1	V
575-3	500-3	E	-	200/220-3	W
-	115-1	F	Misc. A.C. Ratings	X	
-	230-1	G	-	500-3	Y
208-1	200-1	H	-	220/240-1	Z
-	208/230-1	I	200-1	200-1	3
208/230/460-3	200/400-3	K	100-1	100-1	4
-	210/240/380-3	L	200-230-3	-	5
-	380-/420-3	M	230-3	-	6
230/460-3	200/400-3	N	380	346	7
-	200/380-3	P	200/220/380	200/345	8
-	200/240-3	R			

* When applicable, specific 50 HZ ratings (Not necessarily identical to typical shown above) will be shown as alternate on 60 HZ rated models.

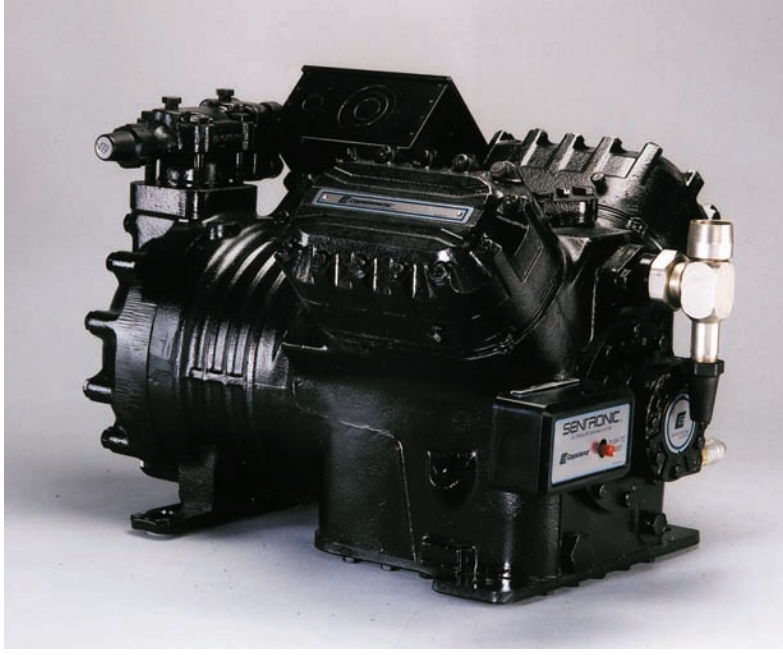

4D and 4R – Semi-Hermetic Compressors

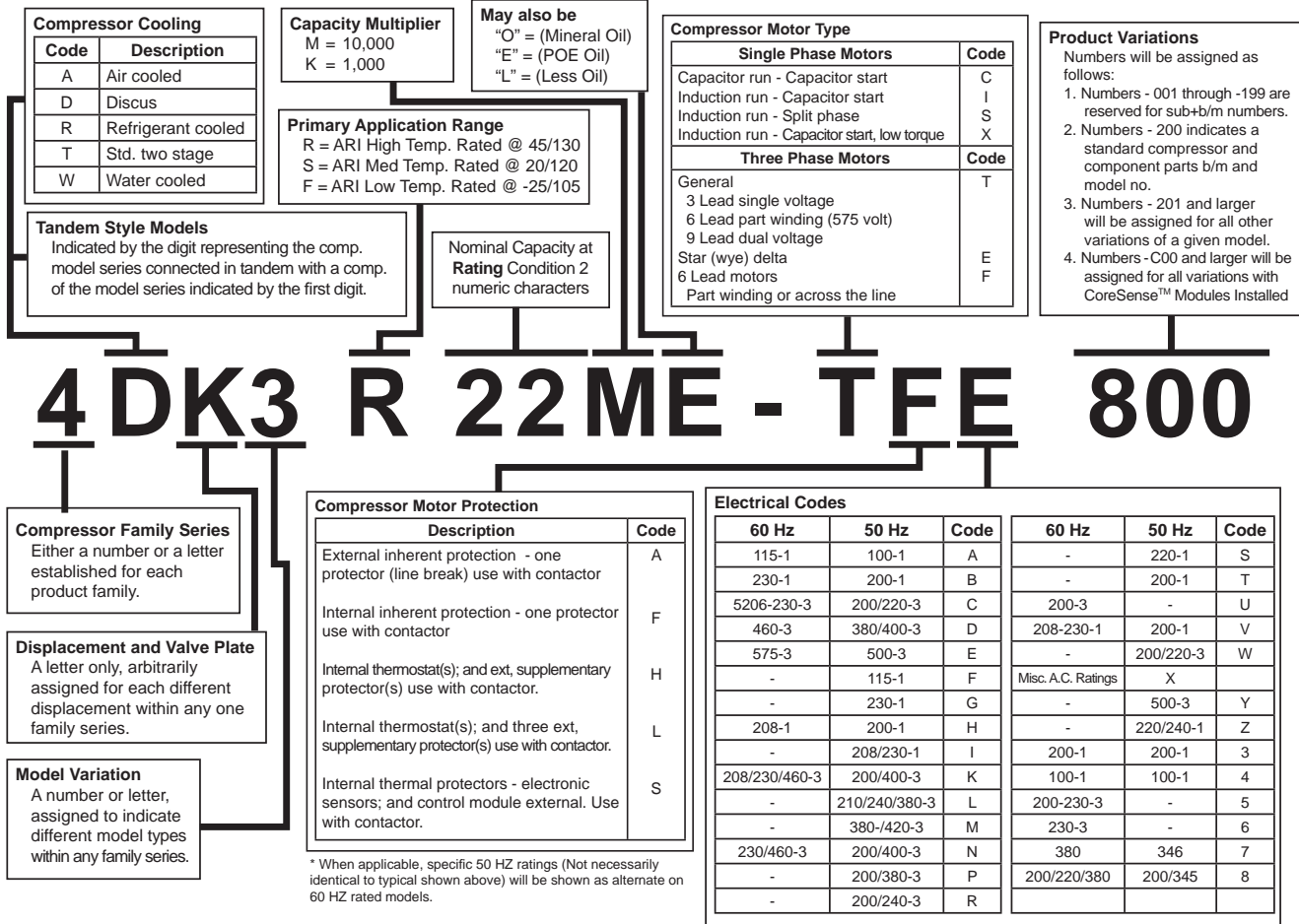

New Model Nomenclature (5th Digit = Application Rating)

- R = Rating at +45°F to +130°F at 90°F Ambient Air
- S = Rating at +20°F to +120°F at 90°F Ambient Air
- F = Rating at -25°F to +105°F at 90° Ambient Air

Common Replacement Parts

Common Parts	Part Number
Sight Glass Kit	998-0002-02
Sight Glass O-Ring	020-0844-05
Oil Screen Kit	998-0513-02
Magnetic Plug Gasket - 1" Internal Thread	020-0006-52
Magnetic Plug Gasket - 1 1/8" Internal Thread	020-0006-38
Oil Pump Kit	998-0008-33
Suction Strainer Assembly	548-0116-00
Terminal Jumpers/Extensions	521-0065-00
Gaskets	Part Number
Complete Gasket Set (Floating Reed)	998-1669-00
Complete Gasket Set (Delta Reed)	998-2669-00
Capacity Control Valve 4D*1/4D*3 Models	020-0783-00
Capacity Control Blank Plate Full Load Gasket	020-0931-00
Housing Cover	020-0636-00
Stator Cover	020-0755-00
Bottom Plate	020-1265-00
Oil Pump	020-1267-00
Crankcase Heater (Flat Bottom Plate Models)	Part Number
120 Volt 100 Watt (US part# 918-0028-00)	518-0028-06
240 Volt 100 Watt (US part# 918-0028-01)	518-0028-07
Crankcase Heater Sleeve	030-0186-01
Crankcase Heater (Deep Sump Models)	Part Number
120V 200 Watt All 4D*8, 4RJ2 & 4RR2 Models	918-0518-00
240V 200 Watt All 4D*8, 4RJ2 & 4RR2 Models	918-0518-01
480V 200 Watt All 4D*8, 4RJ2 & 4RR2 Models	918-0518-02
CoreSense™ Kits and Parts	Part Number
CoreSense Module	943-0128-00
4D/6D CoreSense Wiring Harness	929-0098-00
CoreSense DLT Thermistor	985-0109-50
CoreSense Module Mounting Bracket/Stud Kit	974-1315-00
CoreSense Current Torroid	943-0064-00
Sensor Only Kit	998-0162-01
Copper Gasket for Sensor	020-0297-13
O-Ring Gasket for Sensor	020-0003-28
Solid State Module	Part Number
24 Volt Module	998-0424-06
120/240 Volt Module	998-0524-10
Sensor Terminal Board	580-0054-00
Sentronic 3 Kits and Parts	Part Number
Complete Kit	585-1076-02
Sensor and Cable Kit	998-0162-00
Sensor Only Kit	998-0162-01
Copper Gasket for Sensor	020-0297-13
O-Ring Gasket for Sensor	020-0003-28



4D and 4R – Semi-Hermetic Compressors

Blocked Suction Unloader Valve/ Coil (4D*1, 4D*3)	Part Number	
Valve Less Coil	998-0212-00	
24 Volt Valve and Coil Kit	998-0212-01	
24 Volt Coil Only	023-0091-00	023-0039-09
120 Volt Valve and Coil Kit	998-0212-02	
120 Volt Coil Only	023-0091-01	023-0039-10
240 Volt Valve and Coil Kit	998-0212-03	
240 Volt Coil Only	023-0091-02	023-0039-11
Unloader Piston Kit	998-0130-00	

Digital Unloader Valves & Coils	Part Number
Valve Less Coil - 4D*D models	910-0111-00
24V Coil Only Kit	923-0084-00
120V Coil Only Kit	923-0084-01
240V Coil Only Kit	923-0084-02
Unloader Gasket - 4D*D models	020-1369-01
IDCM Control Module	943-0088-00
Discharge Thermistor	985-0109-07

Cooling Fan Kits

Cooling Fan Kits	Part #	Used On
115 Volt Fan Motor Kit	998-0550-02	
115 Volt Replacement Fan Motor	998-0550-05	
230 Volt Fan Motor Kit	998-0550-00	4R, 4DL & 4DT
230 Volt Replacement Fan Motor	998-0550-03	
460 Volt Fan Motor Kit	998-0550-01	
460 Volt Replacement Fan Motor	998-0550-04	
Fan Mounting Kit	998-0574-03	4R & 4D*1
Fan Mounting Kit	998-0574-12	4D*3
Fan Blade	083-0118-00	4R & 4D

Service Valves

Part #	Size	Discharge	Suction	Style	MTG Center	Thread
998-0510-02	1 1/8"	X		Rotalock		1 3/7"-12
998-0510-46	1 3/8"	X		Rotalock		1 3/7"-12
998-0510-09	1 1/8"	X		Bolt on (2)	2 3/4" x 2 3/4"	
998-0510-11	1 3/8"	X		Bolt on (2)	2 3/4" x 2 3/4"	
998-0510-07	1 5/8"		X	Bolt on (4)	2 1/2" x 2 1/2"	
998-0510-20	2 1/8"		X	Bolt on (4)	3 1/16" x 3 1/16"	

Semi-Hermetic Compressors – 4D and 4R

4D Floating Reed Models - Compressor Parts

Model	Valve Plate Kit	Unloader Valve Plate Kit	Cylinder Head Gasket	Unloader Cylinder Head Gasket	Valve Plate Gasket	Terminal Plate Group
	(998-)	(998-)	(020-)	(020-)	(020-)	(521-)
4DA1-1000-FSD	1661-26		0600-00		0664-07	0140-00
4DA1-1000-TSE	1661-26		0600-00		0664-07	0143-00
4DA1-1000-TSK	1661-26		0600-00		0664-07	0142-00
4DA1-2000-FSD	1661-27		0600-00		0664-07	0140-00
4DA1-2000-TSE	1661-27		0600-00		0664-07	0140-00
4DA1-2000-TSK	1661-27		0600-00		0664-07	0142-00
4DA2-1000-TSE	1661-26		0600-00		0664-07	0143-00
4DA2-2000-TSE	1661-27		0600-00		0664-07	0140-00
4DA2-2000-TSK	1661-27		0600-00		0664-07	0142-00
4DA3-1000-FSD	1661-26		0600-00		0664-07	0140-00
4DA3-1000-TSE	1661-26		0600-00		0664-07	0143-00
4DA3-1000-TSK	1661-26		0600-00		0664-07	0142-00
4DA3-100E-FSD	1661-26		0600-00		0664-07	0140-00
4DA3-100E-TSE	1661-26		0600-00		0664-07	0143-00
4DA3-100E-TSK	1661-26		0600-00		0664-07	0142-00
4DA3-1010-TSE	1661-26		0600-00		0664-07	0143-00
4DA3-1010-TSK	1661-26		0600-00		0664-07	0142-00
4DA3-101E-TSE	1661-26		0600-00		0664-07	0143-00
4DA3-101E-TSK	1661-26		0600-00		0664-07	0142-00
4DA3-2000-FSD	1661-27		0600-00		0664-07	0140-00
4DA3-2000-TSE	1661-27		0600-00		0664-07	0140-00
4DA3-2000-TSK	1661-27		0600-00		0664-07	0142-00
4DA3-200E-FSD	1661-27		0600-00		0664-07	0140-00
4DA3-200E-TSE	1661-27		0600-00		0664-07	0140-00
4DA3-200E-TSK	1661-27		0600-00		0664-07	0142-00
4DA4-2000-TSK	1661-27		0600-00		0664-07	0142-00
4DB3-2200-FSD	1661-27		0600-00		0664-07	0140-00
4DB3-2200-TSE	1661-27		0600-00		0664-03	0140-00
4DB3-2200-TSK	1661-27		0600-00		0664-03	0142-00
4DB3-220E-FSD	1661-27		0600-00		0664-03	0140-00
4DB3-220E-TSE	1661-27		0600-00		0664-03	0140-00
4DB3-220E-TSK	1661-27		0600-00		0664-03	0142-00
• 4DC3-2200-FSD	1661-27	1661-28	0600-00	0616-00	0664-03	0140-00
• 4DC3-2200-TSE	1661-27	1661-28	0600-00	0616-00	0664-03	0140-00
• 4DC3-2200-TSK	1661-27	1661-28	0600-00	0616-00	0664-03	0142-00
• 4DC3-220E-FSD	1661-27	1661-28	0600-00	0616-00	0664-03	0140-00
• 4DC3-220E-TSE	1661-27	1661-28	0600-00	0616-00	0664-03	0140-00
• 4DC3-220E-TSK	1661-27	1661-28	0600-00	0616-00	0664-03	0142-00

• = 1 Bank Unloading

4D and 4R – Semi-Hermetic Compressors

4D Floating Reed Models - Compressor Parts

Model	Valve Plate Kit	Unloader Valve Plate Kit	Cylinder Head Gasket	Unloader Cylinder Head Gasket	Valve Plate Gasket	Terminal Plate Group
	(998-)	(998-)	(020-)	(020-)	(020-)	(521-)
• 4DE1-1000-TSE	1661-26	1661-25	0600-00	0616-00	0664-07	0143-00
• 4DE1-1000-TSK	1661-26	1661-25	0600-00	0616-00	0664-07	0142-00
• 4DE1-2000-FSD	1661-27	1661-28	0600-00	0616-00	0664-07	0140-00
• 4DE1-2000-TSE	1661-27	1661-28	0600-00	0616-00	0664-07	0140-00
• 4DE1-2000-TSK	1661-27	1661-28	0600-00	0616-00	0664-07	0142-00
• 4DE2-2000-TSK	1661-27	1661-28	0600-00	0616-00	0664-07	0142-00
• 4DE3-100E-TSK	1661-26	1661-25	0600-00	0616-00	0664-07	0142-00
• 4DE3-2000-FSD	1661-27	1661-28	0600-00	0616-00	0664-07	0140-00
• 4DE3-2000-TSE	1661-27	1661-28	0600-00	0616-00	0664-07	0140-00
• 4DE3-2000-TSK	1661-27	1661-28	0600-00	0616-00	0664-07	0142-00
• 4DE3-200E-FSD	1661-27	1661-28	0600-00	0616-00	0664-07	0140-00
• 4DE3-200E-TSE	1661-27	1661-28	0600-00	0616-00	0664-07	0140-00
• 4DE3-200E-TSK	1661-27	1661-28	0600-00	0616-00	0664-07	0142-00
• 4DE4-2000-TSK	1661-27	1661-28	0600-00	0616-00	0664-07	0142-00
• 4DE5-2000-TSK	1661-27	1661-28	0600-00	0616-00	0664-07	0142-00
• 4DE8-2000-FSD	1661-27	1661-28	0600-00	0616-00	0664-07	0140-00
• 4DE8-200E-TSK	1661-27	1661-28	0600-00	0616-00	0664-07	0142-00
4DH1-1500-FSD	1661-26		0600-00		0664-03	0140-00
4DH1-1500-TSE	1661-26		0600-00		0664-03	0143-00
4DH1-1500-TSK	1661-26		0600-00		0664-03	0142-00
4DH1-2500-FSD	1661-27		0600-00		0664-03	0140-00
4DH1-2500-TSE	1661-27		0600-00		0664-03	0140-00
4DH1-2500-TSK	1661-27		0600-00		0664-03	0142-00
4DH3-150E-TSE	1661-26		0600-00		0664-03	0143-00
4DH3-150E-TSK	1661-26		0600-00		0664-03	0142-00
4DH3-2500-FSD	1661-27		0600-00		0664-03	0140-00
4DH3-2500-TSE	1661-27		0600-00		0664-03	0140-00
4DH3-2500-TSK	1661-27		0600-00		0664-03	0142-00
4DH3-250E-FSD	1661-27		0600-00		0664-03	0140-00
4DH3-250E-TSE	1661-27		0600-00		0664-03	0140-00
4DH3-250E-TSK	1661-27		0600-00		0664-03	0142-00
4DHB-1500-TSE	1661-26		0600-00		0664-03	0143-00
4DHB-1500-TSK	1661-26		0600-00		0664-03	0142-00
4DJ1-2000-FSD	1661-26		0600-00		0664-05	0140-00
4DJ1-2000-TSE	1661-26		0600-00		0664-05	0140-00
4DJ1-2000-TSK	1661-26		0600-00		0664-05	0142-00
4DJ1-3000-FSD	1661-27		0600-00		0664-05	0140-00
4DJ1-3000-TSE	1661-27		0600-00		0664-05	0140-00

• = 1 Bank Unloading

Semi-Hermetic Compressors – 4D and 4R

4D Floating Reed Models - Compressor Parts

Model	Valve Plate Kit	Unloader Valve Plate Kit	Cylinder Head Gasket	Unloader Cylinder Head Gasket	Valve Plate Gasket	Terminal Plate Group
	(998-)	(998-)	(020-)	(020-)	(020-)	(521-)
4DJ1-3000-TSK	1661-27		0600-00		0664-05	0142-00
4DJ2-2000-TSK	1661-26		0600-00		0664-05	0142-00
4DJ2-3000-TSK	1661-27		0600-00		0664-05	0142-00
4DJ3-200E-TSE	1661-26		0600-00		0664-05	0140-00
4DJ3-200E-TSK	1661-26		0600-00		0664-05	0142-00
4DJ3-3000-FSD	1661-27		0600-00		0664-05	0140-00
4DJ3-3000-TSE	1661-27		0600-00		0664-05	0140-00
4DJ3-3000-TSK	1661-27		0600-00		0664-05	0142-00
4DJ3-300E-FSD	1661-27		0600-00		0664-05	0140-00
4DJ3-300E-TSE	1661-27		0600-00		0664-05	0140-00
4DJ3-300E-TSK	1661-27		0600-00		0664-05	0142-00
4DJ8-200E-TSK	1661-26		0600-00		0664-05	0142-00
4DJ8-3000-TSK	1661-26		0600-00		0664-05	0142-00
• 4DK1-1500-TSK	1661-26	1661-25	0600-00	0616-00	0664-03	0142-00
• 4DK1-2500-FSD	1661-27	1661-28	0600-00	0616-00	0664-03	0140-00
• 4DK1-2500-TSE	1661-27	1661-28	0600-00	0616-00	0664-03	0140-00
• 4DK1-2500-TSK	1661-27	1661-28	0600-00	0616-00	0664-03	0142-00
• 4DK3-150E-FSM	1661-26	1661-25	0600-00	0616-00	0664-03	0140-00
• 4DK3-150E-TSE	1661-26	1661-25	0600-00	0616-00	0664-03	0143-00
• 4DK3-150E-TSK	1661-26	1661-25	0600-00	0616-00	0664-03	0142-00
• 4DK3-2500-FSD	1661-27	1661-28	0600-00	0616-00	0664-03	0140-00
• 4DK3-2500-TSE	1661-27	1661-28	0600-00	0616-00	0664-03	0140-00
• 4DK3-2500-TSK	1661-27	1661-28	0600-00	0616-00	0664-03	0142-00
• 4DK3-250E-FSD	1661-27	1661-28	0600-00	0616-00	0664-03	0140-00
• 4DK3-250E-TSE	1661-27	1661-28	0600-00	0616-00	0664-03	0140-00
• 4DK3-250E-TSK	1661-27	1661-28	0600-00	0616-00	0664-03	0142-00
4DL1-1500-FSD	1661-26	1661-25	0600-00		0664-03	0140-00
4DL1-1500-TSE	1661-26	1661-25	0600-00		0664-03	0143-00
4DL1-1500-TSK	1661-26	1661-25	0600-00		0664-03	0142-00
4DL3-1500-FSD	1661-26	1661-25	0600-00		0664-03	0140-00
4DL3-1500-TSE	1661-26	1661-25	0600-00		0664-03	0143-00
4DL3-1500-TSK	1661-26	1661-25	0600-00		0664-03	0142-00
4DL3-150E-FSD	1661-26	1661-25	0600-00		0664-03	0140-00
4DL3-150E-TSE	1661-26	1661-25	0600-00		0664-03	0143-00
4DL3-150E-TSK	1661-26	1661-25	0600-00		0664-03	0142-00
• 4DN1-1000-FSD	1661-26	1661-25	0600-00	0616-00	0664-07	0140-00
• 4DN1-1000-TSE	1661-26	1661-25	0600-00	0616-00	0664-07	0143-00
• 4DN1-1000-TSK	1661-26	1661-25	0600-00	0616-00	0664-07	0142-00

• = 1 Bank Unloading

4D and 4R – Semi-Hermetic Compressors

4D Floating Reed Models - Compressor Parts

Model	Valve Plate Kit	Unloader Valve Plate Kit	Cylinder Head Gasket	Unloader Cylinder Head Gasket	Valve Plate Gasket	Terminal Plate Group
	(998-)	(998-)	(020-)	(020-)	(020-)	(521-)
• 4DN3-1000-FSD	1661-26	1661-25	0600-00	0616-00	0664-07	0140-00
• 4DN3-1000-TSE	1661-26	1661-25	0600-00	0616-00	0664-07	0143-00
• 4DN3-1000-TSK	1661-26	1661-25	0600-00	0616-00	0664-07	0142-00
• 4DN3-100E-FSD	1661-26	1661-25	0600-00	0616-00	0664-07	0140-00
• 4DN3-100E-TSE	1661-26	1661-25	0600-00	0616-00	0664-07	0143-00
• 4DN3-1010-TSE	1661-26	1661-25	0600-00	0616-00	0664-07	0143-00
• 4DN3-1010-TSK	1661-26	1661-25	0600-00	0616-00	0664-07	0142-00
• 4DN3-101E-TSE	1661-26	1661-25	0600-00	0616-00	0664-07	0143-00
• 4DN3-101E-TSK	1661-26	1661-25	0600-00	0616-00	0664-07	0142-00
• 4DP1-1500-FSD	1661-26	1661-25	0600-00	0616-00	0664-03	0140-00
• 4DP1-1500-TSK	1661-26	1661-25	0600-00	0616-00	0664-03	0142-00
• 4DP3-1500-FSD	1661-26	1661-25	0600-00	0616-00	0664-03	0140-00
• 4DP3-1500-TSE	1661-26	1661-25	0600-00	0616-00	0664-03	0143-00
• 4DP3-1500-TSK	1661-26	1661-25	0600-00	0616-00	0664-03	0142-00
• 4DP3-150E-FSD	1661-26	1661-25	0600-00	0616-00	0664-03	0140-00
• 4DP3-150E-TSE	1661-26	1661-25	0600-00	0616-00	0664-03	0143-00
• 4DP3-150E-TSK	1661-26	1661-25	0600-00	0616-00	0664-03	0142-00
• 4DP8-1500-TSK	1661-26	1661-25	0600-00	0616-00	0664-03	0142-00
• 4DP8-150E-TSK	1661-26	1661-25	0600-00	0616-00	0664-03	0142-00
• 4DR1-2000-TSE	1661-26	1661-28	0600-00	0616-00	0664-05	0140-00
• 4DR1-2000-TSK	1661-26	1661-28	0600-00	0616-00	0664-05	0142-00
• 4DR1-3000-FSD	1661-27	1661-28	0600-00	0616-00	0664-05	0140-00
• 4DR1-3000-TSE	1661-27	1661-28	0600-00	0616-00	0664-05	0140-00
• 4DR1-3000-TSK	1661-27	1661-28	0600-00	0616-00	0664-05	0142-00
• 4DR3-200E-FSM	1661-26	1661-28	0600-00	0616-00	0664-05	0140-00
• 4DR3-200E-TSE	1661-26	1661-28	0600-00	0616-00	0664-05	0140-00
• 4DR3-200E-TSK	1661-26	1661-28	0600-00	0616-00	0664-05	0142-00
• 4DR3-3000-FSD	1661-27	1661-28	0600-00	0616-00	0664-05	0140-00
• 4DR3-3000-TSE	1661-27	1661-28	0600-00	0616-00	0664-05	0140-00
• 4DR3-3000-TSK	1661-27	1661-28	0600-00	0616-00	0664-05	0142-00
• 4DR3-300E-FSD	1661-27	1661-28	0600-00	0616-00	0664-05	0140-00
• 4DR3-300E-TSE	1661-27	1661-28	0600-00	0616-00	0664-05	0140-00
• 4DR3-300E-TSK	1661-27	1661-28	0600-00	0616-00	0664-05	0142-00
• 4DR8-200E-TSK	1661-27	1661-28	0600-00	0616-00	0664-05	0142-00
• 4DRB-2000-TSE	1661-26	1661-28	0600-00	0616-00	0664-05	0140-00
• 4DRB-2000-TSK	1661-26	1661-28	0600-00	0616-00	0664-05	0142-00
• 4DS1-2200-FSD	1661-26	1661-25	0600-00	0616-00	0664-05	0140-00
• 4DS1-2200-TSE	1661-26	1661-25	0600-00	0616-00	0664-05	0140-00

• = 1 Bank Unloading

Semi-Hermetic Compressors – 4D and 4R

4D Floating Reed Models - Compressor Parts

Model	Valve Plate Kit	Unloader Valve Plate Kit	Cylinder Head Gasket	Unloader Cylinder Head Gasket	Valve Plate Gasket	Terminal Plate Group
	(998-)	(998-)	(020-)	(020-)	(020-)	(521-)
• 4DS1-2200-TSK	1661-26	1661-25	0600-00	0616-00	0664-05	0142-00
• 4DS3-2200-FSD	1661-26	1661-25	0600-00	0616-00	0664-05	0140-00
• 4DS3-2200-TSE	1661-26	1661-25	0600-00	0616-00	0664-05	0140-00
• 4DS3-2200-TSK	1661-26	1661-25	0600-00	0616-00	0664-05	0142-00
• 4DS3-220E-FSD	1661-26	1661-25	0600-00	0616-00	0664-05	0140-00
• 4DS3-220E-TSE	1661-26	1661-25	0600-00	0616-00	0664-05	0140-00
• 4DS3-220E-TSK	1661-26	1661-25	0600-00	0616-00	0664-05	0142-00
4DT1-2200-FSD	1661-26		0600-00		0664-05	0140-00
4DT1-2200-TSE	1661-26		0600-00		0664-05	0140-00
4DT1-2200-TSK	1661-26		0600-00		0664-05	0142-00
4DT3-2200-FSD	1661-26		0600-00		0664-05	0140-00
4DT3-2200-TSE	1661-26		0600-00		0664-05	0140-00
4DT3-2200-TSK	1661-26		0600-00		0664-05	0142-00
4DT3-220E-FSD	1661-26		0600-00		0664-05	0140-00
4DT3-220E-TSE	1661-26		0600-00		0664-05	0140-00
4DT3-220E-TSK	1661-26		0600-00		0664-05	0142-00

• = 1 Bank Unloading

4D and 4R – Semi-Hermetic Compressors

4D Delta Reed Models - Compressor Parts

Model (Horse Power Nomenclature)	New Model (BTU Nomenclature)	Delta Valve Plate Kit	Unloader Valve Plate Kit	Cylinder Head Gasket	Unloader Cylinder Head Gasket	Valve Plate Gasket	Terminal Plate Group
		(998-)	(998-)	(020-)	(020-)	(020-)	(521-)
4DA1A1000-FSD	4DA1R12M0-FSD	2661-26		0600-00		1235-05	0140-00
4DA1A1000-TSE	4DA1R12M0-TSE	2661-26		0600-00		1235-05	0143-00
4DA1A1000-TSK	4DA1R12M0-TSK	2661-26		0600-00		1235-05	0142-00
4DA1A2000-FSD	4DA1R18M0-FSD	2661-27		0600-00		1235-05	0140-00
4DA1A2000-TSE	4DA1R18M0-TSE	2661-27		0600-00		1235-05	0140-00
4DA1A2000-TSK	4DA1R18M0-TSK	2661-27		0600-00		1235-05	0142-00
4DA2A1000-TSE	4DA2R12M0-TSE	2661-26		0600-00		1235-05	0143-00
4DA2A2000-TSE	4DA2R18M0-TSE	2661-27		0600-00		1235-05	0140-00
4DA2A2000-TSK	4DA2R18M0-TSK	2661-27		0600-00		1235-05	0142-00
4DA3A1000-FSD	4DA3R12M0-FSD	2661-26		0600-00		1235-05	0140-00
4DA3A1000-TSE	4DA3R12M0-TSE	2661-26		0600-00		1235-05	0143-00
4DA3A1000-TSK	4DA3R12M0-TSK	2661-26		0600-00		1235-05	0142-00
4DA3A100E-FSD	4DA3R12ME-FSD	2661-26		0600-00		1235-05	0140-00
4DA3A100E-TSE	4DA3R12ME-TSE	2661-26		0600-00		1235-05	0143-00
4DA3A100E-TSK	4DA3R12ME-TSK	2661-26		0600-00		1235-05	0142-00
4DA3A1010-TSE	4DA3F47K0-TSE	2661-26		0600-00		1235-05	0143-00
4DA3A1010-TSK	4DA3F47K0-TSK	2661-26		0600-00		1235-05	0142-00
4DA3A101E-TSE	4DA3F47KE-TSE	2661-26		0600-00		1235-05	0143-00
4DA3A101E-TSK	4DA3F47KE-TSK	2661-26		0600-00		1235-05	0142-00
4DA3A2000-FSD	4DA3R18M0-FSD	2661-27		0600-00		1235-05	0140-00
4DA3A2000-TSE	4DA3R18M0-TSE	2661-27		0600-00		1235-05	0140-00
4DA3A2000-TSK	4DA3R18M0-TSK	2661-27		0600-00		1235-05	0142-00
4DA3A200E-FSD	4DA3R18ME-FSD	2661-27		0600-00		1235-05	0140-00
4DA3A200E-TSE	4DA3R18ME-TSE	2661-27		0600-00		1235-05	0140-00
4DA3A200E-TSK	4DA3R18ME-TSK	2661-27		0600-00		1235-05	0142-00
4DA4A2000-TSK	4DA4R18M0-TSK	2661-27		0600-00		1235-05	0142-00
4DB3A2200-FSD	4DB3R20M0-FSD	2661-27		0600-00		1235-01	0140-00
4DB3A2200-TSE	4DB3R20M0-TSE	2661-27		0600-00		1235-01	0140-00
4DB3A2200-TSK	4DB3R20M0-TSK	2661-27		0600-00		1235-01	0142-00
4DB3A220E-FSD	4DB3R20ME-FSD	2661-27		0600-00		1235-01	0140-00
4DB3A220E-TSE	4DB3R20ME-TSE	2661-27		0600-00		1235-01	0140-00
4DB3A220E-TSK	4DB3R20ME-TSK	2661-27		0600-00		1235-01	0142-00
4DC3A2200-FSD	4DC3R20M0-FSD	2661-27	2661-28	0600-00	0616-00	1235-01	0140-00
• 4DC3A2200-TSE	4DC3R20M0-TSE	2661-27	2661-28	0600-00	0616-00	1235-01	0140-00
• 4DC3A2200-TSK	4DC3R20M0-TSK	2661-27	2661-28	0600-00	0616-00	1235-01	0142-00
• 4DC3A220E-FSD	4DC3R20ME-FSD	2661-27	2661-28	0600-00	0616-00	1235-01	0140-00

• = 1 Bank Unloading

Semi-Hermetic Compressors – 4D and 4R

4D Delta Reed Models - Compressor Parts

Model (Horse Power Nomenclature)	New Model (BTU Nomenclature)	Delta Valve Plate Kit	Unloader Valve Plate Kit	Cylinder Head Gasket	Unloader Cylinder Head Gasket	Valve Plate Gasket	Terminal Plate Group
		(998-)	(998-)	(020-)	(020-)	(020-)	(521-)
• 4DC3A220E-TSE	4DC3R20ME-TSE	2661-27	2661-28	0600-00	0616-00	1235-01	0140-00
• 4DC3A220E-TSK	4DC3R20ME-TSK	2661-27	2661-28	0600-00	0616-00	1235-01	0142-00
• 4DE1A1000-TSE	4DE1R12M0-TSE	2661-26	2661-25	0600-00	0616-00	1235-05	0143-00
• 4DE1A1000-TSK	4DE1R12M0-TSK	2661-26	2661-25	0600-00	0616-00	1235-05	0142-00
• 4DE1A2000-FSD	4DE1R18M0-FSD	2661-27	2661-28	0600-00	0616-00	1235-05	0140-00
• 4DE1A2000-TSE	4DE1R18M0-TSE	2661-27	2661-28	0600-00	0616-00	1235-05	0140-00
• 4DE1A2000-TSK	4DE1R18M0-TSK	2661-27	2661-28	0600-00	0616-00	1235-05	0142-00
• 4DE2A2000-TSK	4DE2R18M0-TSK	2661-27	2661-28	0600-00	0616-00	1235-05	0142-00
• 4DE3A100E-TSK	4DE3R12ME-TSK	2661-26	2661-25	0600-00	0616-00	1235-05	0142-00
• 4DE3A2000-FSD	4DE3R18M0-FSD	2661-27	2661-28	0600-00	0616-00	1235-05	0140-00
• 4DE3A2000-TSE	4DE3R18M0-TSE	2661-27	2661-28	0600-00	0616-00	1235-05	0140-00
• 4DE3A2000-TSK	4DE3R18M0-TSK	2661-27	2661-28	0600-00	0616-00	1235-05	0142-00
• 4DE3A200E-FSD	4DE3R18ME-FSD	2661-27	2661-28	0600-00	0616-00	1235-05	0140-00
• 4DE3A200E-TSE	4DE3R18ME-TSE	2661-27	2661-28	0600-00	0616-00	1235-05	0140-00
• 4DE3A200E-TSK	4DE3R18ME-TSK	2661-27	2661-28	0600-00	0616-00	1235-05	0142-00
• 4DE4A2000-TSK	4DE4R18M0-TSK	2661-27	2661-28	0600-00	0616-00	1235-05	0142-00
• 4DE8A2000-FSD	4DE8R18M0-FSD	2661-27	2661-28	0600-00	0616-00	1235-05	0140-00
• 4DE8A200E-TSK	4DE8R18ME-TSK	2661-27	2661-28	0600-00	0616-00	1235-05	0142-00
4DH1A1500-FSD	4DH1R16M0-FSD	2661-26		0600-00		1235-01	0140-00
4DH1A1500-TSE	4DH1R16M0-TSE	2661-26		0600-00		1235-01	0143-00
4DH1A1500-TSK	4DH1R16M0-TSK	2661-26		0600-00		1235-01	0142-00
4DH1A2500-FSD	4DH1R22M0-FSD	2661-27		0600-00		1235-01	0140-00
4DH1A2500-TSE	4DH1R22M0-TSE	2661-27		0600-00		1235-01	0140-00
4DH1A2500-TSK	4DH1R22M0-TSK	2661-27		0600-00		1235-01	0142-00
4DH3A150E-TSE	4DH3R16ME-TSE	2661-26		0600-00		1235-01	0143-00
4DH3A150E-TSK	4DH3R16ME-TSK	2661-26		0600-00		1235-01	0142-00
4DH3A2500-FSD	4DH3R22M0-FSD	2661-27		0600-00		1235-01	0140-00
4DH3A2500-TSE	4DH3R22M0-TSE	2661-27		0600-00		1235-01	0140-00
4DH3A2500-TSK	4DH3R22M0-TSK	2661-27		0600-00		1235-01	0142-00
4DH3A250E-FSD	4DH3R22ME-FSD	2661-27		0600-00		1235-01	0140-00
4DH3A250E-TSE	4DH3R22ME-TSE	2661-27		0600-00		1235-01	0140-00
4DH3A250E-TSK	4DH3R22ME-TSK	2661-27		0600-00		1235-01	0142-00
4DJ1A2000-FSD	4DJ1R19M0-FSD	2661-26		0600-00		1235-03	0140-00
4DJ1A2000-TSE	4DJ1R19M0-TSE	2661-26		0600-00		1235-03	0140-00
4DJ1A2000-TSK	4DJ1R19M0-TSK	2661-26		0600-00		1235-03	0142-00
4DJ1A3000-FSD	4DJ1R28M0-FSD	2661-27		0600-00		1235-03	0140-00

• = 1 Bank Unloading

4D and 4R – Semi-Hermetic Compressors

4D Delta Reed Models - Compressor Parts

Model (Horse Power Nomenclature)	New Model (BTU Nomenclature)	Delta Valve Plate Kit	Unloader Valve Plate Kit	Cylinder Head Gasket	Unloader Cylinder Head Gasket	Valve Plate Gasket	Terminal Plate Group
		(998-)	(998-)	(020-)	(020-)	(020-)	(521-)
4DJ1A3000-TSE	4DJ1R28M0-TSE	2661-27		0600-00		1235-03	0140-00
4DJ1A3000-TSK	4DJ1R28M0-TSK	2661-27		0600-00		1235-03	0142-00
4DJ2A2000-TSK	4DJ2R19M0-TSK	2661-26		0600-00		1235-03	0142-00
4DJ2A3000-TSK	4DJ2R28M0-TSK	2661-27		0600-00		1235-03	0142-00
4DJ3A200E-TSE	4DJ3R19ME-TSE	2661-26		0600-00		1235-03	0140-00
4DJ3A200E-TSK	4DJ3R19ME-TSK	2661-26		0600-00		1235-03	0142-00
4DJ3A3000-FSD	4DJ3R28M0-FSD	2661-27		0600-00		1235-03	0140-00
4DJ3A3000-TSE	4DJ3R28M0-TSE	2661-27		0600-00		1235-03	0140-00
4DJ3A3000-TSK	4DJ3R28M0-TSK	2661-27		0600-00		1235-03	0142-00
4DJ3A300E-FSD	4DJ3R28ME-FSD	2661-27		0600-00		1235-03	0140-00
4DJ3A300E-TSE	4DJ3R28ME-TSE	2661-27		0600-00		1235-03	0140-00
4DJ3A300E-TSK	4DJ3R28ME-TSK	2661-27		0600-00		1235-03	0142-00
4DJ8A200E-TSK	4DJ8R19ME-TSK	2661-26		0600-00		1235-03	0142-00
4DJ8A3000-TSK	4DJ8R28M0-TSK	2661-26		0600-00		1235-03	0142-00
• 4DK1A1500-TSK	4DK1R16M0-TSK	2661-26	2661-25	0600-00	0616-00	1235-01	0142-00
• 4DK1A2500-FSD	4DK1R22M0-FSD	2661-27	2661-28	0600-00	0616-00	1235-01	0140-00
• 4DK1A2500-TSE	4DK1R22M0-TSE	2661-27	2661-28	0600-00	0616-00	1235-01	0140-00
• 4DK1A2500-TSK	4DK1R16M0-TSK	2661-27	2661-28	0600-00	0616-00	1235-01	0142-00
• 4DK3A150E-FSM	4DK3R16ME-FSM	2661-26	2661-25	0600-00	0616-00	1235-01	0140-00
• 4DK3A150E-TSE	4DK3R16ME-TSE	2661-26	2661-25	0600-00	0616-00	1235-01	0143-00
• 4DK3A150E-TSK	4DK3R16ME-TSK	2661-26	2661-25	0600-00	0616-00	1235-01	0142-00
• 4DK3A2500-FSD	4DK3R22M0-FSD	2661-27	2661-28	0600-00	0616-00	1235-01	0140-00
• 4DK3A2500-TSE	4DK3R22M0-TSE	2661-27	2661-28	0600-00	0616-00	1235-01	0140-00
• 4DK3A2500-TSK	4DK3R22M0-TSK	2661-27	2661-28	0600-00	0616-00	1235-01	0142-00
• 4DK3A250E-FSD	4DK3R22ME-FSD	2661-27	2661-28	0600-00	0616-00	1235-01	0140-00
• 4DK3A250E-TSE	4DK3R22ME-TSE	2661-27	2661-28	0600-00	0616-00	1235-01	0140-00
• 4DK3A250E-TSK	4DK3R22ME-TSK	2661-27	2661-28	0600-00	0616-00	1235-01	0142-00
4DL1A1500-FSD	4DL1F63K0-FSD	2661-26	2661-25	0600-00		1235-01	0140-00
4DL1A1500-TSE	4DL1F63K0-TSE	2661-26	2661-25	0600-00		1235-01	0143-00
4DL1A1500-TSK	4DL1F63K0-TSK	2661-26	2661-25	0600-00		1235-01	0142-00
4DL3A1500-FSD	4DL3F63K0-FSD	2661-26	2661-25	0600-00		1235-01	0140-00
4DL3A1500-TSE	4DL3F63K0-TSE	2661-26	2661-25	0600-00		1235-01	0143-00
4DL3A1500-TSK	4DL3F63K0-TSK	2661-26	2661-25	0600-00		1235-01	0142-00
4DL3A150E-FSD	4DL3F63KE-FSD	2661-26	2661-25	0600-00		1235-01	0140-00
4DL3A150E-TSE	4DL3F63KE-TSE	2661-26	2661-25	0600-00		1235-01	0143-00
4DL3A150E-TSK	4DL3F63KE-TSK	2661-26	2661-25	0600-00		1235-01	0142-00

• = 1 Bank Unloading

Semi-Hermetic Compressors – 4D and 4R

4D Delta Reed Models - Compressor Parts

Model (Horse Power Nomenclature)	New Model (BTU Nomenclature)	Delta Valve Plate Kit	Unloader Valve Plate Kit	Cylinder Head Gasket	Unloader Cylinder Head Gasket	Valve Plate Gasket	Terminal Plate Group
		(998-)	(998-)	(020-)	(020-)	(020-)	(521-)
• 4DN1A1000-FSD	N/A	2661-26	2661-25	0600-00	0616-00	1235-05	0140-00
• 4DN1A1000-TSE	N/A	2661-26	2661-25	0600-00	0616-00	1235-05	0143-00
• 4DN1A1000-TSK	N/A	2661-26	2661-25	0600-00	0616-00	1235-05	0142-00
• 4DN3A1000-FSD	N/A	2661-26	2661-25	0600-00	0616-00	1235-05	0140-00
• 4DN3A1000-TSE	N/A	2661-26	2661-25	0600-00	0616-00	1235-05	0143-00
• 4DN3A1000-TSK	N/A	2661-26	2661-25	0600-00	0616-00	1235-05	0142-00
• 4DN3A100E-FSD	N/A	2661-26	2661-25	0600-00	0616-00	1235-05	0140-00
• 4DN3A100E-TSE	N/A	2661-26	2661-25	0600-00	0616-00	1235-05	0143-00
• 4DN3A1010-TSE	4DN3F47K0-TSE	2661-26	2661-25	0600-00	0616-00	1235-05	0143-00
• 4DN3A1010-TSK	4DN3F47K0-TSK	2661-26	2661-25	0600-00	0616-00	1235-05	0142-00
• 4DN3A101E-TSE	4DN3F47KE-TSE	2661-26	2661-25	0600-00	0616-00	1235-05	0143-00
• 4DN3A101E-TSK	4DN3F47KE-TSK	2661-26	2661-25	0600-00	0616-00	1235-05	0142-00
• 4DP1A1500-FSD	4DP1F63K0-FSD	2661-26	2661-25	0600-00	0616-00	1235-01	0140-00
• 4DP1A1500-TSK	4DP1F63K0-TSK	2661-26	2661-25	0600-00	0616-00	1235-01	0142-00
• 4DP3A1500-FSD	4DP3F63K0-FSD	2661-26	2661-25	0600-00	0616-00	1235-01	0140-00
• 4DP3A1500-TSE	4DP3F63K0-TSE	2661-26	2661-25	0600-00	0616-00	1235-01	0143-00
• 4DP3A1500-TSK	4DP3F63K0-TSK	2661-26	2661-25	0600-00	0616-00	1235-01	0142-00
• 4DP3A150E-FSD	4DP3F63KE-FSD	2661-26	2661-25	0600-00	0616-00	1235-01	0140-00
• 4DP3A150E-TSE	4DP3F63KE-TSE	2661-26	2661-25	0600-00	0616-00	1235-01	0143-00
• 4DP3A150E-TSK	4DP3F63KE-TSK	2661-26	2661-25	0600-00	0616-00	1235-01	0142-00
• 4DP8A1500-TSK	4DP8F63K0-TSK	2661-26	2661-25	0600-00	0616-00	1235-01	0142-00
• 4DP8A150E-TSK	4DP8F63KE-TSK	2661-26	2661-25	0600-00	0616-00	1235-01	0142-00
• 4DR1A2000-TSE	4DR1R19M0-TSE	2661-26	2661-28	0600-00	0616-00	1235-03	0140-00
• 4DR1A2000-TSK	4DR1R19M0-TSK	2661-26	2661-28	0600-00	0616-00	1235-03	0142-00
• 4DR1A3000-FSD	4DR1R28M0-FSD	2661-27	2661-28	0600-00	0616-00	1235-03	0140-00
• 4DR1A3000-TSE	4DR1R28M0-TSE	2661-27	2661-28	0600-00	0616-00	1235-03	0140-00
• 4DR1A3000-TSK	4DR1R28M0-TSK	2661-27	2661-28	0600-00	0616-00	1235-03	0142-00
• 4DR3A200E-TSE	4DR3R19ME-TSE	2661-26	2661-28	0600-00	0616-00	1235-03	0140-00
• 4DR3A200E-TSK	4DR3R19ME-TSK	2661-26	2661-28	0600-00	0616-00	1235-03	0142-00
• 4DR3A3000-FSD	4DR3R28M0-FSD	2661-27	2661-28	0600-00	0616-00	1235-03	0140-00
• 4DR3A3000-TSE	4DR3R28M0-TSE	2661-27	2661-28	0600-00	0616-00	1235-03	0140-00
• 4DR3A3000-TSK	4DR3R28M0-TSK	2661-27	2661-28	0600-00	0616-00	1235-03	0142-00
• 4DR3A300E-FSD	4DR3R28ME-FSD	2661-27	2661-28	0600-00	0616-00	1235-03	0140-00
• 4DR3A300E-TSE	4DR3R28ME-TSE	2661-27	2661-28	0600-00	0616-00	1235-03	0140-00
• 4DR3A300E-TSK	4DR3R28ME-TSK	2661-27	2661-28	0600-00	0616-00	1235-03	0142-00
• 4DR8A200E-TSK	4DR8R19ME-TSK	2661-27	2661-28	0600-00	0616-00	1235-03	0142-00

• = 1 Bank Unloading

4D and 4R – Semi-Hermetic Compressors

4D Delta Reed Models - Compressor Parts

Model (Horse Power Nomenclature)	New Model (BTU Nomenclature)	Delta Valve Plate Kit	Unloader Valve Plate Kit	Cylinder Head Gasket	Unloader Cylinder Head Gasket	Valve Plate Gasket	Terminal Plate Group
		(998-)	(998-)	(020-)	(020-)	(020-)	(521-)
• 4DS1A2200-FSD	4DS1F76K0-FSD	2661-26	2661-25	0600-00	0616-00	1235-03	0140-00
• 4DS1A2200-TSE	4DS1F76K0-TSE	2661-26	2661-25	0600-00	0616-00	1235-03	0140-00
• 4DS1A2200-TSK	4DS1F76K0-TSK	2661-26	2661-25	0600-00	0616-00	1235-03	0142-00
• 4DS3A2200-FSD	4DS3F76K0-FSD	2661-26	2661-25	0600-00	0616-00	1235-03	0140-00
• 4DS3A2200-TSE	4DS3F76K0-TSE	2661-26	2661-25	0600-00	0616-00	1235-03	0140-00
• 4DS3A2200-TSK	4DS3F76K0-TSK	2661-26	2661-25	0600-00	0616-00	1235-03	0142-00
• 4DS3A220E-FSD	4DS3F76KE-FSD	2661-26	2661-25	0600-00	0616-00	1235-03	0140-00
• 4DS3A220E-TSE	4DS3F76KE-TSE	2661-26	2661-25	0600-00	0616-00	1235-03	0140-00
• 4DS3A220E-TSK	4DS3F76KE-TSK	2661-26	2661-25	0600-00	0616-00	1235-03	0142-00
4DT1A2200-FSD	4DT1F76K0-FSD	2661-26		0600-00		1235-03	0140-00
4DT1A2200-TSE	4DT1F76K0-TSE	2661-26		0600-00		1235-03	0140-00
4DT1A2200-TSK	4DT1F76K0-TSK	2661-26		0600-00		1235-03	0142-00
4DT3A2200-FSD	4DT3F76K0-FSD	2661-26		0600-00		1235-03	0140-00
4DT3A2200-TSE	4DT3F76K0-TSE	2661-26		0600-00		1235-03	0140-00
4DT3A2200-TSK	4DT3F76K0-TSK	2661-26		0600-00		1235-03	0142-00
4DT3A220E-FSD	4DT3F76KE-FSD	2661-26		0600-00		1235-03	0140-00
4DT3A220E-TSE	4DT3F76KE-TSE	2661-26		0600-00		1235-03	0140-00
4DT3A220E-TSK	4DT3F76KE-TSK	2661-26		0600-00		1235-03	0142-00

• = 1 Bank Unloading

4D Compressor Capacity Control Kits

Standard Model	Blocked Suction Capacity Control Model	Digital Capacity Control Model	Capacity Control Conversion Kit with 24V Unloader	Capacity Control Conversion Kit with 120V Unloader	Capacity Control Conversion Kit with 240V Unloader
4DA3A101*	4DE3A101*		998-2119-35	998-2119-36	998-2119-37
4DA3A200*	4DE3R18M*		998-2119-31	998-2119-32	998-2119-33
4DB3A220*	4DC3R20M*		998-2119-31	998-2119-32	998-2119-33
4DL3A150*	4DL3F63K*		998-2119-35	998-2119-36	998-2119-37
4DH3A150*	4DK3R16M*		998-2119-31	998-2119-32	998-2119-33
4DH3A250*	4DK3R22M*		998-2119-31	998-2119-32	998-2119-33
4DT3A220*	4DS3F76M*		998-2119-35	998-2119-36	998-2119-37
4DJ3A200*	4DR3R19M*		998-2119-31	998-2119-32	998-2119-33
4DJ3R28M*	4DR3R28M*		998-2119-31	998-2119-32	998-2119-33
4DA3F47K*	4DE3F47K*		998-2119-35	998-2119-36	998-2119-37
4DA3F47K*		4DADF47KE	980-6000-01	980-6000-01	980-6000-01
4DA3R18M*	4DE3R18M*		998-2119-31	998-2119-32	998-2119-33
4DA3R18M*		4DADR18ME	980-6000-00	980-6000-00	980-6000-00
4DB3R20M*	4DC3R20M*		998-2119-31	998-2119-32	998-2119-33
4DB3R20M*		4DBDR20ME	980-6000-00	980-6000-00	980-6000-00
4DL3F63K*	4DL3F63K*		998-2119-35	998-2119-36	998-2119-37
4DL3F63K*		4DLDF63KE	980-6000-01	980-6000-01	980-6000-01
4DH3R16M*	4DK3R16M*		998-2119-31	998-2119-32	998-2119-33
4DH3R22M*	4DK3R22M*		998-2119-31	998-2119-32	998-2119-33
4DH3R22M*		4DHDR22ME	980-6000-00	980-6000-00	980-6000-00
4DT3F76M*	4DS3F76M*		998-2119-35	998-2119-36	998-2119-37
4DT3F76M*		4DTDF76ME	980-6000-01	980-6000-01	980-6000-01
4DJ3R19M*	4DR3R19M*		998-2119-31	998-2119-32	998-2119-33
4DJ3R28M*	4DR3R28M*		998-2119-31	998-2119-32	998-2119-33
4DJ3R28M*		4DJDR28ME	980-6000-00	980-6000-00	980-6000-00

Note: Digital conversion kits include 24V, 120V, 240V unloader solenoids and IDCM module.

Digital conversion kits shown are for standard Copeland Discus compressors.

Contact Emerson's Technical Department to obtain kit numbers for Copeland Discus compressors with CoreSense Diagnostics.

* = E (for POE oil models), 0 (for mineral oil models) or L (for less oil models)

4D and 4R – Semi-Hermetic Compressors

4R - Compressor Parts

Model	Valve Plate Kit	Complete Gasket Set	Cylinder Head Gasket	Valve Plate Gasket	Terminal Plate Group
	(998-)	(998-)	(020-)	(020-)	(521-)
4RA3-1000-FSM	0661-00	0669-00	0629-00	0626-00	0140-00
4RA3-1000-TSE	0661-00	0669-00	0629-00	0626-00	0143-00
4RA3-1000-TSK	0661-00	0669-00	0629-00	0626-00	0142-00
4RA3-2000-FSD	0661-52	0669-00	0629-00	0626-00	0140-00
4RA3-2000-TSE	0661-52	0669-00	0629-00	0626-00	0140-00
4RA3-2000-TSK	0661-52	0669-00	0629-00	0626-00	0142-00
4RA4-1000-TSE	0661-00	0669-00	0629-00	0626-00	0143-00
4RA4-1000-TSK	0661-00	0669-00	0629-00	0626-00	0142-00
4RA4-2000-FSD	0661-52	0669-00	0629-00	0626-00	0140-00
4RA4-2000-TSE	0661-52	0669-00	0629-00	0626-00	0140-00
4RA4-2000-TSK	0661-52	0669-00	0629-00	0626-00	0142-00
• 4RE2-1000-FSM	0661-66	0669-00	0629-00	0626-00	0140-00
• 4RE2-1000-TSE	0661-66	0669-00	0629-00	0626-00	0143-00
• 4RE2-1000-TSK	0661-66	0669-00	0629-00	0626-00	0142-00
• 4RE2-2000-FSD	0661-52	0669-00	0629-00	0626-00	0140-00
• 4RE2-2000-TSE	0661-52	0669-00	0629-00	0626-00	0140-00
• 4RE2-2000-TSK	0661-52	0669-00	0629-00	0626-00	0142-00
4RH1-1500-FSM	0661-51	0669-54	0629-00	0627-00	0140-00
4RH1-1500-TSE	0661-51	0669-54	0629-00	0627-00	0143-00
4RH1-1500-TSK	0661-51	0669-54	0629-00	0627-00	0142-00
4RH1-2500-FSD	0661-51	0669-54	0629-00	0627-00	0140-00
4RH1-2500-TSE	0661-51	0669-54	0629-00	0627-00	0140-00
4RH1-2500-TSK	0661-51	0669-54	0629-00	0627-00	0142-00
4RJ1-2000-FSM	0661-60	0669-55	0629-00	0628-01	0140-00
4RJ1-3000-FSD	0661-60	0669-55	0629-00	0628-01	0140-00
4RJ1-3000-TSE	0661-60	0669-55	0629-00	0628-01	0140-00
4RJ1-3000-TSK	0661-60	0669-55	0629-00	0628-01	0142-00
4RJ2-2000-FSM	0661-60	0669-55	0629-00	0628-01	0140-00
4RJ2-3000-FSD	0661-60	0669-55	0629-00	0628-01	0140-00
4RJ2-3000-TSE	0661-60	0669-55	0629-00	0628-01	0140-00
4RJ2-3000-TSK	0661-60	0669-55	0629-00	0628-01	0142-00
• 4RK2-1500-FSM	0661-51	0669-54	0629-00	0627-00	0140-00
• 4RK2-1500-TSE	0661-51	0669-54	0629-00	0627-00	0143-00
• 4RK2-1500-TSK	0661-51	0669-54	0629-00	0627-00	0142-00
• 4RK2-2500-FSD	0661-51	0669-54	0629-00	0627-00	0140-00
• 4RK2-2500-TSE	0661-51	0669-54	0629-00	0627-00	0140-00
• 4RK2-2500-TSK	0661-51	0669-54	0629-00	0627-00	0142-00
4RL1-1500-FSM	0661-49	0669-54	0629-00	0627-00	0140-00
4RL1-1500-TSE	0661-49	0669-54	0629-00	0627-00	0141-00
4RL1-1500-TSK	0661-49	0669-54	0629-00	0627-00	0142-00

• = 1 Bank Unloading

4R - Compressor Parts

Model	Valve Plate Kit	Complete Gasket Set	Cylinder Head Gasket	Valve Plate Gasket	Terminal Plate Group
	(998-)	(998-)	(020-)	(020-)	(521-)
• 4RR1-3000-FSD	0661-60	0669-55	0629-00	0628-01	0140-00
• 4RR1-3000-TSE	0661-60	0669-55	0629-00	0628-01	0140-00
• 4RR1-3000-TSK	0661-60	0669-55	0629-00	0628-01	0142-00
• 4RR2-3000-FSD	0661-60	0669-55	0629-00	0628-01	0140-00
• 4RR2-3000-TSE	0661-60	0669-55	0629-00	0628-01	0140-00
• 4RR2-3000-TSK	0661-60	0669-55	0629-00	0628-01	0142-00

• = 1 Bank Unloading

4R Compressor Capacity Control Kits

Standard Model	Capacity Control Model	Capacity Control Conversion Kit with 24V Unloader	Capacity Control Conversion Kit with 120V Unloader	Capacity Control Conversion Kit with 240V Unloader
4RA*-1000	4RE*-1000	998-0119-08	998-0119-09	998-0119-10
4RA*-2000	4RE*-2000	998-0119-08	998-0119-09	998-0119-10
4RH*-1500	4RK*-1500	998-0119-08	998-0119-09	998-0119-10
4RH*-2500	4RK*-2500	998-0119-08	998-0119-09	998-0119-10
4RJ*-2000	4RR*-2000	998-0119-16	998-0119-17	998-0119-18
4RJ*-3000	4RR*-3000	998-0119-16	998-0119-17	998-0119-18

Note: The position occupied by * can be the number 1, 2, 3, 4, or 8

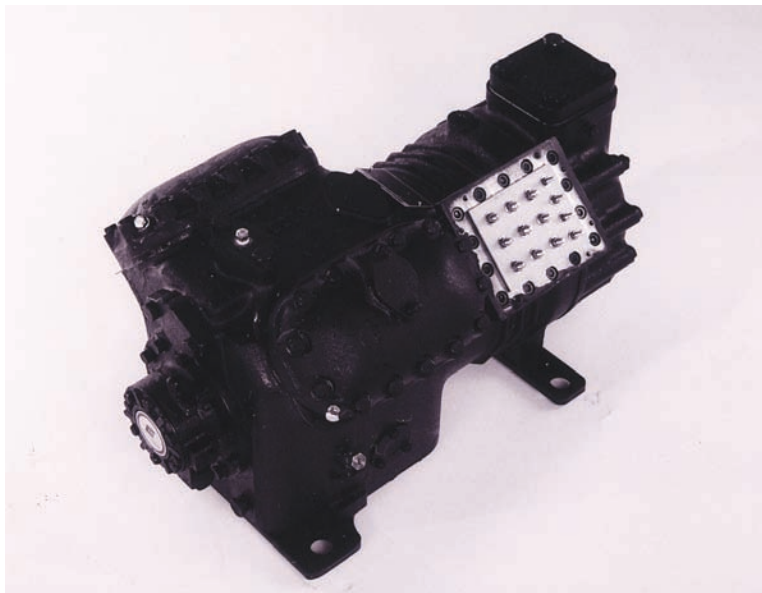

4D Copeland Discus™ III – Semi-Hermetic Compressors

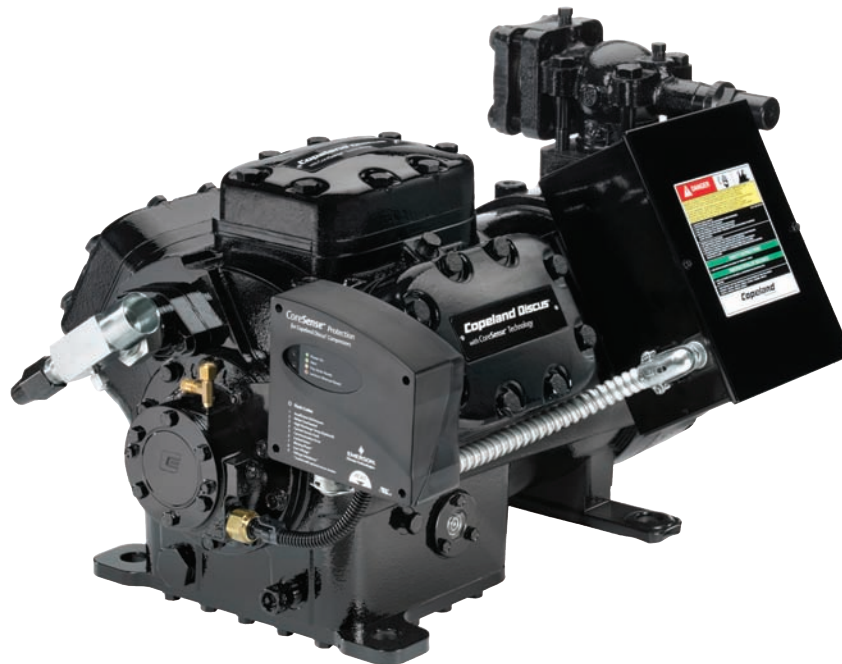
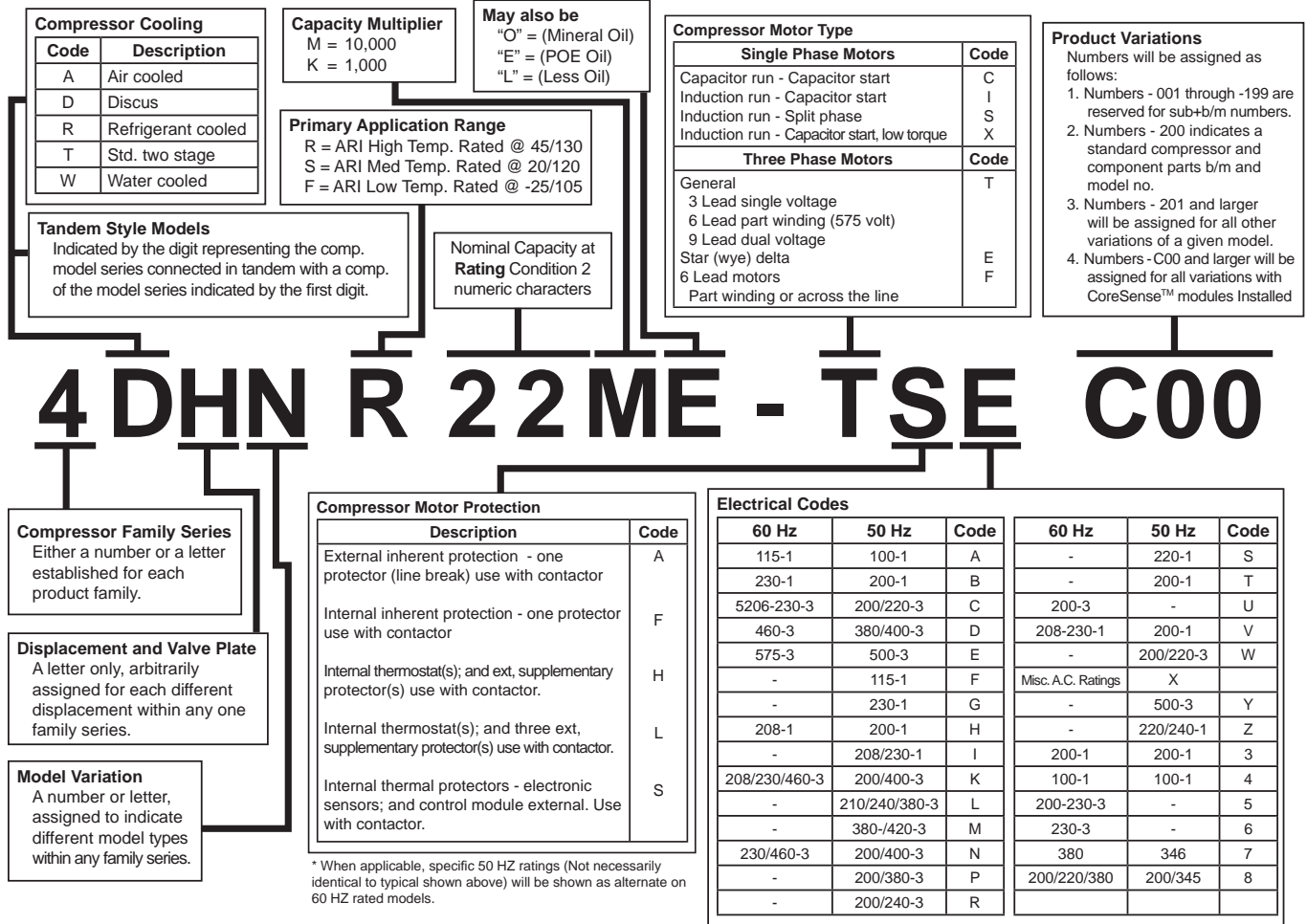

Semi-Hermetic Compressors – 4D Copeland Discus™ III

Copeland Discus™ III to Copeland Discus™ II cross reference matrix

Use this matrix to determine required accessory kits if you are replacing a field-failed Copeland Discus™ III compressor with a Copeland Discus™ II service model.

4D	Kit Number		Do I need this Kit? Check the Discus™ III nomenclature	Kit includes:	Special notes
	CoreSense™ Protection	CoreSense™ Diagnostics (ISD)			
Electronics Kit	974-1315-00	998-3000-04	4DKNF63KE-TSE- C 00 C = Protection kit 4DKNF63KE-TSE- A 00 A = Diagnostics kit	Mounting parts (studs and nuts) necessary to reinstall CoreSense™ Protection or Diagnostics on Discus™ II service models.	You will never need both of these kits, but you will always need one. (The exception is the -441 BOM. In this case, neither kit is required.)
Low Temp Kit	998-3000-14 (Demand Cooling™) 998-0574-12 (head fan) 998-0574-20 (digital head fan)		4DKNF 6 3KE-TSE-A00 You need it if this digit is F**	Head fan and Demand Cooling™ mounting kits (including studs and nuts)	Depending on the refrigerant in the system, you may not need to use the demand cooling mounting parts.
Unloading Kit	998-0212-00 (less coil) 998-0212-02 (115V coil) 998-0212-03 (208/220V coil)	998-0212-00 (less coil) 998-0212-01 (24V)	4DK 6 NF63KE-TSE-A00 You need it if this digit is anything except H, J, B or G	Gasket and solenoid valve assembly	4D models receive one unloading kit. NOTE: It is possible unloading has been added to the compressor at the time of install. If this is the case, an unloading kit will be required.

** Refer to OEM equipment guidelines. Demand Cooling is only used in R-22, R-407A, R-407C and R-407F applications.

Due to the lack of an installed base for remanufacturing, Emerson Climate Technologies, Inc. have decided at this time to replace Discus III compressors that fail in the field with Discus II. The primary reason for this decision is to avoid the need for wholesalers to stock two separate models for the same application.

4D Copeland Discus™ III – Semi-Hermetic Compressors

Common Replacement Parts

Common Parts	Part Number
Sight Glass Kit	998-0002-02
Sight Glass O-Ring	020-0844-05
Oil Screen Kit	998-0513-02
Magnetic Plug Gasket - 1" Internal Thread	020-0006-52
Magnetic Plug Gasket - 1 1/8" Internal Thread	020-0006-38
Oil Pump Kit	998-0008-33
Suction Strainer Assembly	548-0116-00
Terminal Jumpers/Extensions	521-0065-00
Gaskets	Part Number
Complete Gasket Set (Discus III)	998-3669-00
Capacity Control Valve	
Discus III - 4D*N Models	020-1465-00
Capacity Control Blank Plate (Full Load Gasket) Discus III - 4D*N Models	020-1445-00
Stator Cover	020-0755-00
Bottom Plate	020-1265-00
Oil Pump	020-1267-00
Housing Cover	020-1545-00
CoreSense™ Kits and Parts	Part Number
CoreSense Module	943-0128-00
4D/6D CoreSense Wiring Harness	929-0098-00
CoreSense DLT Thermistor	985-0109-50
CoreSense Module Mounting Bracket/Stud Kit	974-1315-00
CoreSense Current Torroid	943-0064-00
Sensor Only Kit	998-0162-01
Copper Gasket for Sensor	020-0297-13
O-Ring Gasket for Sensor	020-0003-28
Crankcase Heater (Flat Bottom Plate Models)	Part Number
120V 100 Watt (US part# 918-0028-00)	518-0028-06
240V 100 Watt (US part# 918-0028-01)	518-0028-07
Crankcase Heater Sleeve	030-0186-01



Common Replacement Parts

Digital Compressor Unloader Valve/Coil	Part Number
Valve Less Coil - 4D*X Models	910-0127-00
24 Volt Coil Only	923-0084-00
120 Volt Coil Only	923-0084-01
240 Volt Coil Only	923-0084-02
IDCM Module	943-0088-00
Digital Unloader Gasket - 4D*X Models	020-1446-00
Blocked Suction Unloader Valves & Coils	Part Number
Valve Less Coil	998-0213-00
24 Volt Valve and Coil Kit	998-0213-01
24 Volt Coil Only	023-0091-00
120 Volt Valve and Coil Kit	998-0213-02
120 Volt Coil Only	023-0091-01
240 Volt Valve and Coil Kit	998-0213-03
240 Volt Coil Only	023-0091-02
Unloader Piston Kit	998-0130-00

Cooling Fan Kits

Cooling Fan Kits	Part #	Used On
115 Volt Fan Motor Kit	998-0550-02	All 4D Discus III
115 Volt Replacement Fan Motor	998-0550-05	All 4D Discus III
230 Volt Fan Motor Kit	998-0550-00	All 4D Discus III
230 Volt Replacement Fan Motor	998-0550-03	All 4D Discus III
460 Volt Fan Motor Kit	998-0550-01	All 4D Discus III
460 Volt Replacement Fan Motor	998-0550-04	All 4D Discus III
Fan Mounting Kit	998-0574-16	All 4D*N/4D*X Models
Fan Blade	083-0118-00	All 4D Discus III

Service Valves

Part #	Size	Discharge	Suction	Style	MTG Center	Thread
998-0510-02	1 1/8"	X		Rotalock		1 3/7"-12
998-0510-46	1 3/8"	X		Rotalock		1 3/7"-12
998-0510-09	1 1/8"	X		Bolt on (2)	2 3/4" x 2 3/4"	
998-0510-11	1 3/8"	X		Bolt on (2)	2 3/4" x 2 3/4"	
998-0510-07	1 5/8"		X	Bolt on (4)	2 1/2" x 2 1/2"	
998-0510-20	2 1/8"		X	Bolt on (4)	3 1/16" x 3 1/16"	

4D Copeland Discus™ III – Semi-Hermetic Compressors

4D Discus™ III Delta Reed Models - Compressor Parts

Model	Equivalent Digital Model	Standard Valve Plate Kit	Unloader Valve Plate Kit	Cylinder Head Gasket	Unloader Cylinder Head Gasket	Valve Plate Gasket	Terminal Plate Group
		(998-)	(998-)	(020-)	(020-)	(020-)	(521-)
4DBNF54KE-TSE	4DBXF54KE-TSE	3661-26		1505-00		1450-00	0143-00
4DBNF54KE-TSK	4DBXF54KE-TSK	3661-26		1505-00		1450-00	0142-00
4DBNR20ME-FSD	4DBXR20ME-FSD	3661-27		1505-00		1450-00	0140-00
4DBNR20ME-TSE	4DBXR20ME-TSE	3661-27		1505-00		1450-00	0140-00
4DBNR20ME-TSK	4DBXR20ME-TSK	3661-27		1505-00		1450-00	0142-00
D 4DBXF54KE-TSE		3661-26	3661-65	1505-00	1455-00	1450-00	0143-00
D 4DBXF54KE-TSK		3661-26	3661-65	1505-00	1455-00	1450-00	0142-00
D 4DBXR20ME-FSD		3661-27	3661-66	1505-00	1455-00	1450-00	0140-00
D 4DBXR20ME-TSE		3661-27	3661-66	1505-00	1455-00	1450-00	0140-00
D 4DBXR20ME-TSK		3661-27	3661-66	1505-00	1455-00	1450-00	0142-00
• 4DCNF54KE-TSE	4DBXF54KE-TSE	3661-26	3661-25	1505-00	1454-00	1450-00	0143-00
• 4DCNF54KE-TSK	4DBXF54KE-TSK	3661-26	3661-25	1505-00	1454-00	1450-00	0142-00
• 4DCNR20ME-FSD	4DBXR20ME-FSD	3661-27	3661-28	1505-00	1454-00	1450-00	0140-00
• 4DCNR20ME-TSE	4DBXR20ME-TSE	3661-27	3661-28	1505-00	1454-00	1450-00	0140-00
• 4DCNR20ME-TSK	4DBXR20ME-TSK	3661-27	3661-28	1505-00	1454-00	1450-00	0142-00
4DHNF63KE-FSD	4DHXF63KE-FSD	3661-26		1505-00			0140-00
4DHNF63KE-TSE	4DHXF63KE-TSE	3661-26		1505-00		1450-01	0143-00
4DHNF63KE-TSK	4DHXF63KE-TSK	3661-26		1505-00		1450-01	0142-00
4DHNR16ME-TSK	N/A	3661-27		1505-00		1450-01	0142-00
4DHNR22ME-FSD	4DHXR22ME-FSD	3661-27		1505-00		1450-01	0140-00
4DHNR22ME-TSE	4DHXR22ME-TSE	3661-27		1505-00		1450-01	0140-00
4DHNR22ME-TSK	4DHXR22ME-TSK	3661-27		1505-00		1450-01	0142-00
D 4DHXF63KE-FSD		3661-26	3661-65	1505-00	1455-00	1450-01	0140-00
D 4DHXF63KE-TSE		3661-26	3661-65	1505-00	1455-00	1450-01	0143-00
D 4DHXF63KE-TSK		3661-26	3661-65	1505-00	1455-00	1450-01	0142-00
D 4DHXR22ME-FSD		3661-27	3661-66	1505-00	1455-00	1450-01	0140-00
D 4DHXR22ME-TSE		3661-27	3661-66	1505-00	1455-00	1450-01	0140-00
D 4DHXR22ME-TSK		3661-27	3661-66	1505-00	1455-00	1450-01	0142-00
4DJNF76ME-FSD	4DJXF76ME-FSD	3661-26		1505-00		1450-03	0140-00
4DJNF76ME-TSE	4DJXF76ME-TSK	3661-26		1505-00		1450-03	0140-00
4DJNF76ME-TSK	4DJXF76ME-TSE	3661-26		1505-00		1450-03	0142-00
4DJNR19ME-TSK	N/A	3661-27		1505-00		1450-03	0142-00
4DJNR28ME-FSD	4DJXR28ME-FSD	3661-27		1505-00		1450-03	0140-00
4DJNR28ME-TSE	4DJXR28ME-TSE	3661-27		1505-00		1450-03	0140-00
4DJNR28ME-TSK	4DJXR28ME-TSK	3661-27		1505-00		1450-03	0142-00
D 4DJXF76ME-FSD		3661-26	3661-65	1505-00	1455-00	1450-03	0140-00
D 4DJXF76ME-TSE		3661-26	3661-65	1505-00	1455-00	1450-03	0140-00
D 4DJXF76ME-TSK		3661-26	3661-65	1505-00	1455-00	1450-03	0142-00

D = Digital Model
 • = 1 Bank Unloading

New Model Nomenclature (5th Digit = Application Rating)
 R = Rating at +45°F to +130°F at 90°F Ambient Air
 S = Rating at +20°F to +120°F at 90°F Ambient Air
 F = Rating at -25°F to +105°F at 90° Ambient Air

4D Discus™ III Delta Reed Models - Compressor Parts

Model	Equivalent Digital Model	Standard Valve Plate Kit	Unloader Valve Plate Kit	Cylinder Head Gasket	Unloader Cylinder Head Gasket	Valve Plate Gasket	Terminal Plate Group
		(998-)	(998-)	(020-)	(020-)	(020-)	(521-)
D 4DJXR28ME-FSD		3661-27	3661-66	1505-00	1455-00	1450-03	0140-00
D 4DJXR28ME-TSE		3661-27	3661-66	1505-00	1455-00	1450-03	0140-00
D 4DJXR28ME-TSK		3661-27	3661-66	1505-00	1455-00	1450-03	0142-00
• 4DKNF63KE-FSD	4DHXF63KE-FSD	3661-26	3661-25	1505-00	1454-00	1450-01	0140-00
• 4DKNF63KE-TSE	4DHXF63KE-TSE	3661-26	3661-25	1505-00	1454-00	1450-01	0143-00
• 4DKNF63KE-TSK	4DHXF63KE-TSK	3661-26	3661-25	1505-00	1454-00	1450-01	0142-00
• 4DKNR16ME-TSE	N/A	3661-27	3661-28	1505-00	1454-00	1450-01	0143-00
• 4DKNR16ME-TSK	N/A	3661-27	3661-28	1505-00	1454-00	1450-01	0142-00
• 4DKNR22ME-FSD	4DHXR22ME-FSD	3661-27	3661-28	1505-00	1454-00	1450-01	0140-00
• 4DKNR22ME-TSE	4DHXR22ME-TSE	3661-27	3661-28	1505-00	1454-00	1450-01	0140-00
• 4DKNR22ME-TSK	4DHXR22ME-TSK	3661-27	3661-28	1505-00	1454-00	1450-01	0142-00
• 4DRNF76KE-FSD	4DJXF76KE-FSD	3661-26	3661-25	1505-00	1454-00	1450-03	0140-00
• 4DRNF76KE-TSE	4DJXF76KE-TSE	3661-26	3661-25	1505-00	1454-00	1450-03	0140-00
• 4DRNF76KE-TSK	4DJXF76KE-TSK	3661-26	3661-25	1505-00	1454-00	1450-03	0142-00
• 4DRNR19ME-TSK		3661-27	3661-28	1505-00	1454-00	1450-03	0142-00
• 4DRNR28ME-FSD	4DJXR28ME-FSD	3661-27	3661-28	1505-00	1454-00	1450-03	0140-00
• 4DRNR28ME-TSE	4DJXR28ME-TSE	3661-27	3661-28	1505-00	1454-00	1450-03	0140-00
• 4DRNR28ME-TSK	4DJXR28ME-TSK	3661-27	3661-28	1505-00	1454-00	1450-03	0142-00

D = Digital Model
 • = 1 Bank Unloading

New Model Nomenclature (5th Digit = Application Rating)
 R = Rating at +45°F to +130°F at 90°F Ambient Air
 S = Rating at +20°F to +120°F at 90°F Ambient Air
 F = Rating at -25°F to +105°F at 90° Ambient Air

4D Copeland Discus™ III – Semi-Hermetic Compressors

4D Discus™ III Compressor Capacity Control Kits

Standard Model	Blocked Suction Capacity Control Model	Digital Capacity Control Model	Capacity Control Conversion Kit with 24V Unloader	Capacity Control Conversion Kit with 120V Unloader	Capacity Control Conversion Kit with 240V Unloader
4DBNF54KE	4DCNF54KE		998-3119-27	998-3119-28	998-3119-29
4DBNF54KE		4DBXF54KE	980-5000-01	980-5000-01	980-5000-01
4DBNR20ME	4DCNR20ME		998-3119-22	998-3119-23	998-3119-24
4DBNR20ME		4DBXR20ME	980-5000-00	980-5000-00	980-5000-00
4DHNF63KE	4DKNF63KE		998-3119-27	998-3119-28	998-3119-29
4DHNF63KE		4DHXF63KE	980-5000-01	980-5000-01	980-5000-01
4DHNR16ME	4DKNR16ME		998-3119-22	998-3119-23	998-3119-24
4DHNR22ME	4DKNR22ME		998-3119-22	998-3119-23	998-3119-24
4DHNR22ME		4DHXR22ME	980-5000-00	980-5000-00	980-5000-00
4DJNF76ME	4DRNF76ME		998-3119-27	998-3119-28	998-3119-29
4DJNF76ME		4DJXF76ME	980-5000-01	980-5000-01	980-5000-01
4DJNR19ME	4DJNR19ME		998-3119-22	998-3119-23	998-3119-24
4DJNR28ME	4DRNR28ME		998-3119-22	998-3119-23	998-3119-24
4DJNR28ME		4DJXR28ME	980-5000-00	980-5000-00	980-5000-00

Note - Digital conversion kits include 24V, 120V, 240V unloader solenoids and IDCM module.



CO₂ Semi-Hermetic Compressors – 4M

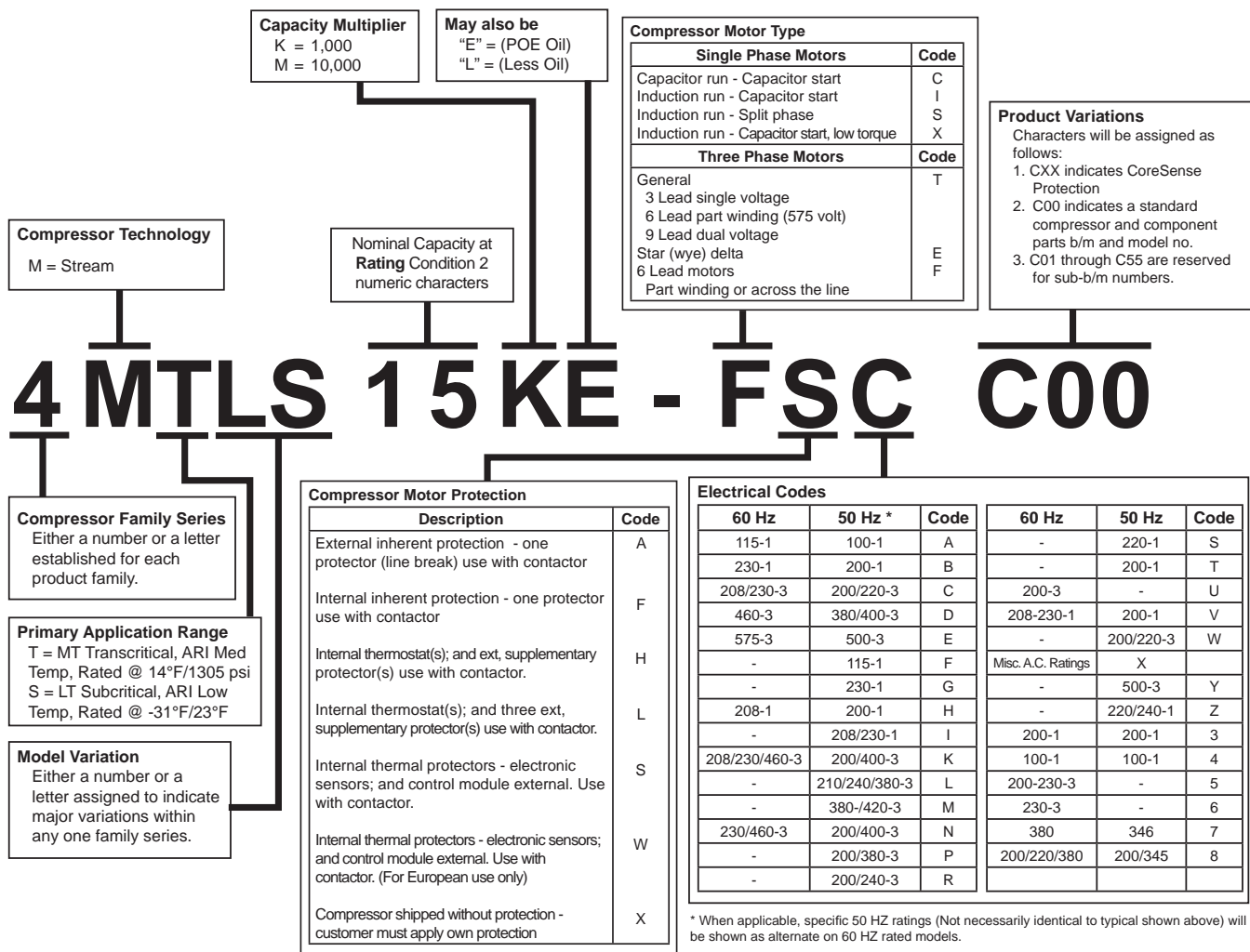

4M – CO₂ Semi-Hermetic Compressors

CO ₂ Service Parts Kit	Part Number
Sight Glass Kit	970-0026-00
Oil Sensor CO2 Kit	998-0244-00
Low Pressure Release Valve Kit	910-0006-00
High Pressure Release Valve Kit	910-0006-01
Shut-off Valves Kit	910-0006-02
Bolt Head Kit	911-0105-00
Bolt Stator Kit	911-0105-01
Bolt Housing Kit	911-0105-02
Crankcase Heater Kit 115 Volt 100 Watt	918-0003-00
Crankcase Heater Kit 230 Volt 100 Watt	918-0003-01
Gasket Shut-off Valve Kit	920-0015-00
Gasket Stator Kit	920-0015-01
Gasket Housing Kit	920-0015-02
Gasket Cylinder Head Gasket Kit	920-0015-03
Terminal Plate Gasket FSC Kit	920-0019-01
Terminal Plate FSC	921-0022-00
Compressor Mounting Kit	927-0041-00
CoreSense™ Kit	943-0030-00
Suction Filter Kit	998-0256-00

4M CO₂ Models - Compressor Parts

Model	Valve Plate K	Complete Gasket	Valve Plate Gasket
	(903-)	(920-)	
4MTLS11ME-FSC	0986-01	0015-00	020-1501-00
4MTLS15ME-TSE	0986-02	0015-00	020-1502-00
4MTLS82KL-FSD	0986-00	0015-00	020-1500-00
4MTLS11ML-FSD	0986-01	0015-00	020-1501-00
4MTLS15ML-FSD	0986-02	0015-00	020-1502-00
4MTLS82KL-FSD	0986-00	0015-00	020-1500-00
4MTLS11ML-FSD	0986-01	0015-00	020-1501-00
4MTLS15ML-FSD	0986-02	0015-00	020-1502-00
4MTLS11ME-FSD	0986-01	0015-00	020-1501-00
4MTLS11ME-TSE	0986-01	0015-00	020-1501-00
4MTLS11ML-TSE	0986-01	1501-00	020-1501-00
4MTLS15ME-FSC	0986-02	0015-00	020-1502-00
4MTLS15ME-FSD	0986-02	0015-00	020-1502-00
4MTLS15ML-TSE	0986-02	0015-00	020-1502-00
4MTLS82KE-FSC	0986-00	0015-00	020-1500-00
4MTLS82KE-FSD	0986-00	0015-00	020-1500-00
4MTLS82KE-TSE	0986-00	0015-00	020-1500-00
4MTLS82KL-TSE	0986-00	0015-00	020-1500-00

Semi-Hermetic Compressors – 6D, 6R and 6T

Compressor Cooling	
Code	Description
A	Air cooled
D	Discus
R	Refrigerant cooled
T	Std. two stage
W	Water cooled

Comp. Motor Rating Nominal					
HP	Code	HP	Code	HP	Code
1/4	0025	2-3/4	0275	15	1500
1/3	0033	3 (0310)	0300	20	2000
1/2	0050	3-1/2	0350	25	2500
3/4	0075	4 (0406)	0400	30	3000
1	0100	5 (0506)	0500	35	3500
1-1/4	0125	6	0600	40	4000
1-1/2	0150	7-1/2 (0766)	0750	50	5000
1-3/4	0175	9	0900	60	6000
2	0200	10 (1015)	1000		
2-1/2	0250	12	1200		

Compressor Motor Type		Code
Single Phase Motors		Code
Capacitor run - Capacitor start		C
Induction run - Capacitor start		I
Induction run - Split phase		S
Induction run - Capacitor start, low torque		X
Three Phase Motors		Code
General		T
3 Lead single voltage		
6 Lead part winding (575 volt)		
9 Lead dual voltage		
Star (wye) delta		
6 Lead motors		E
Part winding or across the line		F

Product Variations
Numbers will be assigned as follows:
1. Numbers -001 through -199 are reserved for sub+b/m numbers.
2. Numbers -200 indicates a standard compressor and component parts b/m and model no.
3. Numbers -201 and larger will be assigned for all other variations of a given model.

Tandem Style Models
Indicated by the digit representing the comp. model series connected in tandem with a comp. of the model series indicated by the first digit.

May be = (-) or A
Note: Nominal horsepower rating of tandem compressors is sum of individual compressor ratings

6RN2 - 3000 - TSE 800

Compressor Motor Protection	
Description	Code
External inherent protection - one protector (line break) use with contactor	A
Internal inherent protection - one protector use with contactor	F
Internal thermostat(s); and ext. supplementary protector(s) use with contactor.	H
Internal thermostat(s); and three ext. supplementary protector(s) use with contactor.	L
Internal thermal protectors - electronic sensors; and control module external. Use with contactor.	S
Internal thermal protectors - electronic sensors; and control module external. use with contactor (For European use only).	W

Electrical Codes					
60 Hz	50 Hz	Code	60 Hz	50 Hz	Code
115-1	100-1	A	-	220-1	S
230-1	200-1	B	-	200-1	T
5206-230-3	200/220-3	C	200-3	-	U
460-3	380/400-3	D	208-230-1	200-1	V
575-3	500-3	E	-	200/220-3	W
-	115-1	F	Misc. A.C. Ratings	X	
-	230-1	G	-	500-3	Y
208-1	200-1	H	-	220/240-1	Z
-	208/230-1	I	200-1	200-1	3
208/230/460-3	200/400-3	K	100-1	100-1	4
-	210/240/380-3	L	200-230-3	-	5
-	380/420-3	M	230-3	-	6
230/460-3	200/400-3	N	380	346	7
-	200/380-3	P	200/220/380	200/345	8
-	200/240-3	R			

Compressor Family Series
Either a number or a letter established for each product family.

Displacement and Valve Plate
A letter only, arbitrarily assigned for each different displacement within any one family series.

Model Variation
A number or letter, assigned to indicate different model types within any family series.

May also be
"A" = (Alkylbenzene)
"E" = (POE Oil)
"L" = (Less Oil)

*When applicable, specific 50 Hz ratings (Not necessarily identical to typical shown above) will be shown as alternate on 60 HZ rated models.



6D, 6R and 6T – Semi-Hermetic Compressors

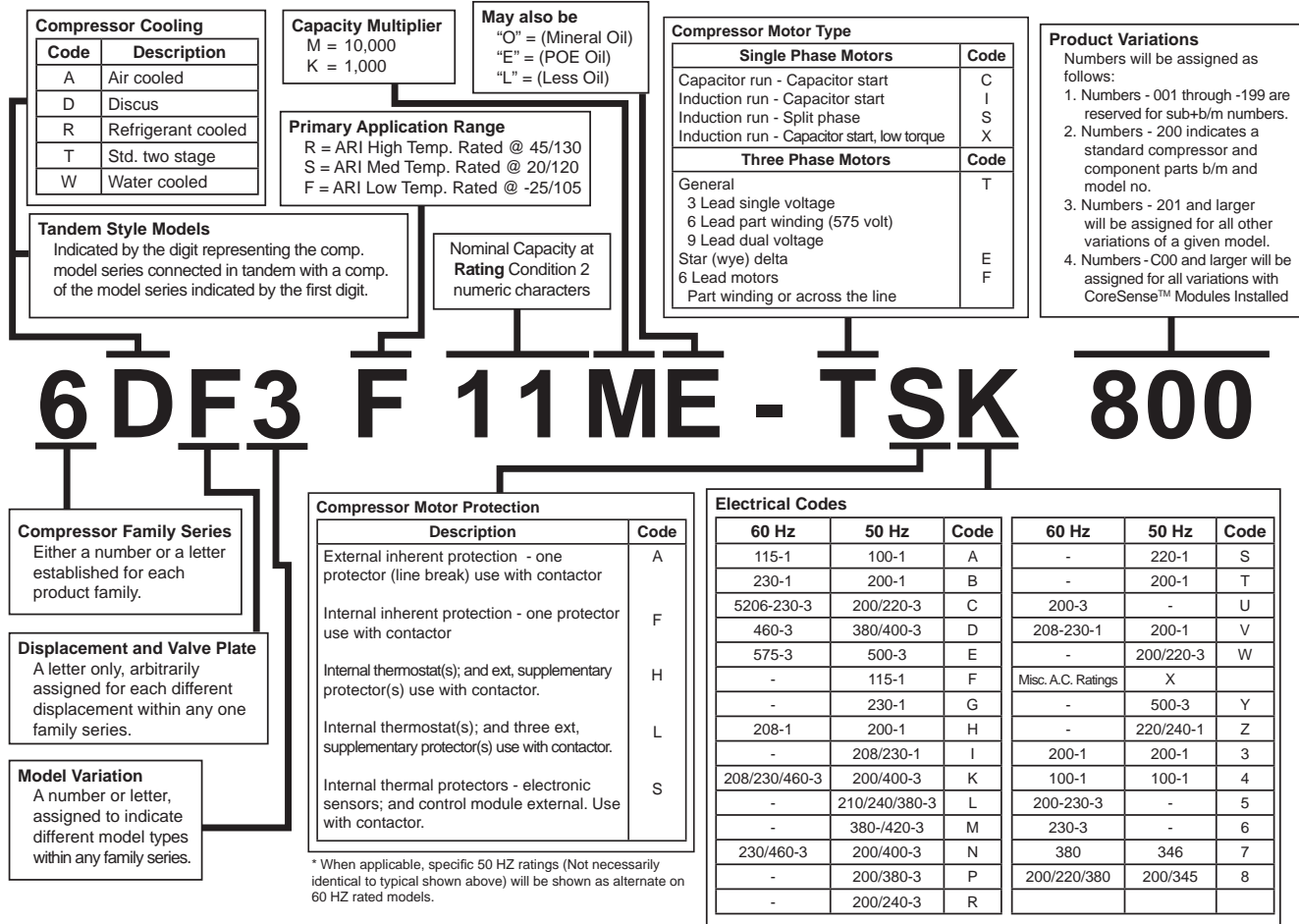

Unloader Valves and Coils	Part Number	Obsolete (Alco) Valve
Valve Less Coil	998-0212-00	
24 Volt Valve and Coil Kit	998-0212-01	
24 Volt Coil Only	023-0091-00	023-0039-09
120 Volt Valve and Coil Kit	998-0212-02	
120 Volt Coil Only	023-0091-01	023-0039-10
240 Volt Valve and Coil Kit	998-0212-03	
240 Volt Coil Only	023-0091-02	023-0039-11
Unloader Piston Kit	998-0130-00	

Semi-Hermetic Compressors – 6D, 6R and 6T

Common Replacement Parts

Common Parts	Part Number
Sight Glass Kit	998-0002-02
Sight Glass O-Ring	020-0844-05
Oil Screen Kit	998-0513-02
Magnetic Plug Gasket - 1" Internal Thread	020-0006-52
Magnetic Plug Gasket - 1 1/8" Internal Thread	020-0006-38
Oil Pump Kit	998-0008-33
Suction Strainer Assembly	548-0116-00
Terminal Jumpers/Extensions	521-0065-00
Gaskets	Part Number
Complete Gasket Set (Floating Reed)	998-1669-01
Complete Gasket Set (Delta Reed)	998-2669-01
Unloading Valve	020-0783-00
Housing Cover	020-0636-00
Stator Cover	020-0755-00
Bottom Plate	020-1265-00
Oil Pump	020-1267-00
Crankcase Heater (Flat Bottom Plate Models)	Part Number
120 Volt 100 Watt (US part# 918-0028-00)	518-0028-06
240 Volt 100 Watt (US part# 918-0028-01)	518-0028-07
Crankcase Heater Sleeve	030-0186-01
Crankcase Heater (Deep Sump Models)	Part Number
120V 200 Watt All 6DJ/R/S, 6DT/E/F & 6D*8	918-0518-00
240V 200 Watt All 6DJ/R/S, 6DT/E/F & 6D*8	918-0518-01
480V 200 Watt All 6DJ/R/S, 6DT/E/F & 6D*8	918-0518-02
CoreSense™ Parts	Part Number
CoreSense Module	943-0109-00
6R/6D CoreSense Wiring Harness	929-0098-00
CoreSense DLT Thermistor	985-0109-50
CoreSense Module Mounting Bracket/Stud Kit	974-1315-00
Sensor Only Kit	998-0162-01
Copper Gasket for Sensor	020-0297-13
O-Ring Gasket for Sensor	020-0003-28
Solid State Module	Part Number
24 Volt Module	998-0424-06
120/240 Volt Module	998-0524-10
Sensor Terminal Board	580-0054-00
Sentronic 3 Kits and Parts	Part Number
Complete Kit	585-1076-02
Sensor and Cable Kit	998-0162-00
Sensor Only Kit	998-0162-01
Copper Gasket for Sensor	020-0297-13
O-Ring Gasket for Sensor	020-0003-28

6D, 6R and 6T – Semi-Hermetic Compressors

Cooling Fan Kits

Cooling Fan Kits	Part Number	Used On
115 Volt Fan Motor Kit	998-0550-02	All 6D's & 6R's
115 Volt Replacement Fan Motor	998-0550-05	All 6D's & 6R's
230 Volt Fan Motor Kit	998-0550-00	All 6D's & 6R's
230 Volt Replacement Fan Motor	998-0550-03	All 6D's & 6R's
460 Volt Fan Motor Kit	998-0550-01	All 6D's & 6R's
460 Volt Replacement Fan Motor	998-0550-04	All 6D's & 6R's
Fan Mounting Kit	998-0574-04	6D*1 & 6R's (Small Head)
Fan Mounting Kit	998-0574-05	6RL's, 6RT's, 6DL1 & 6DT1
Fan Mounting Kit	998-0574-13	6D*3's Only
Fan Blade	083-0118-00	All 6D's & 6R's

Oil Screen Kits

Oil Screen Kits	Part Number	Used On
Oil Screen Kit	998-0513-02	All 6D's
Oil Screen Kit	998-0513-00	All 6R's & 6T's

Oil Cooler Kits

Oil Cooler Kits	Part Number	Used On
Oil Cooler Kit	998-1123-00	6RL/T & 6D*1 (Small Head)
Oil Cooler Kit	998-1126-00	6D*3's
Tee Fitting	036-0415-01	All 6D's & 6R's

Service Valves

Part #	Size	Discharge	Suction	Style	MTG Center	Thread
998-0510-46	1 3/8"	X		Rotalock		1 3/4"-12
998-0510-66	1 5/8"	X		Rotalock		1 3/4"-12
998-0510-11	1 3/8"		X	Bolt on (2)	2 1/4" x 2 1/4"	
998-0510-07	1 5/8"		X	Bolt on (4)	2 1/2" x 2 1/2"	
998-0510-20	2 1/8"		X	Bolt on (4)	3 1/16" x 3 1/16"	

Digital Compressor Parts	Part #
Valve Less Coil - 6D*D models	910-0111-00
24V Coil Only Kit	923-0084-00
120V Coil Only Kit	923-0084-01
240V Coil Only Kit	923-0084-02
Unloader Gasket	020-1369-01
IDCM Control Module	943-0194-00
Discharge Thermistor	985-0109-07
Unloader Piston Kit	998-0130-00

Semi-Hermetic Compressors – 6D, 6R and 6T

6D Floating Reed Models - Compressor Parts

Model	Valve Plate Kit	Unloader Valve Plate Kit	Cylinder Head Gasket	Unloader Cylinder Head Gasket	Valve Plate Gasket	Terminal Plate Group
	(998-)	(998-)	(020-)	(020-)	(020-)	(521-)
6DB3-3000-FSD	1661-27		0600-00		0664-03	0140-01
6DB3-3000-TSE	1661-27		0600-00		0664-03	0140-01
6DB3-3000-TSK	1661-27		0600-00		0664-03	0142-01
6DB3-300E-FSD	1661-27		0600-00		0664-03	0140-01
6DB3-300E-TSE	1661-27		0600-00		0664-03	0140-01
6DB3-300E-TSK	1661-27		0600-00		0664-03	0142-01
• 6DC1-2700-TSE	1661-26	1661-25	0600-00	0616-00	0664-03	0140-00
• 6DC1-2700-TSK	1661-26	1661-25	0600-00	0616-00	0664-03	0142-00
• 6DC3-2700-FSD	1661-26	1661-25	0600-00	0616-00	0664-03	0140-00
• 6DC3-2700-TSE	1661-26	1661-25	0600-00	0616-00	0664-03	0140-00
• 6DC3-2700-TSK	1661-26	1661-25	0600-00	0616-00	0664-03	0142-00
• 6DC3-270E-FSD	1661-26	1661-25	0600-00	0616-00	0664-03	0140-00
• 6DC3-270E-TSE	1661-26	1661-25	0600-00	0616-00	0664-03	0140-00
• 6DC3-270E-TSK	1661-26	1661-25	0600-00	0616-00	0664-03	0142-00
•• 6DD1-2700-FSD	1661-26	1661-25	0600-00	0616-00	0664-03	0140-00
•• 6DD1-2700-TSK	1661-26	1661-25	0600-00	0616-00	0664-03	0142-00
•• 6DD3-2700-FSD	1661-26	1661-25	0600-00	0616-00	0664-03	0140-00
•• 6DD3-2700-TSE	1661-26	1661-25	0600-00	0616-00	0664-03	0140-00
•• 6DD3-2700-TSK	1661-26	1661-25	0600-00	0616-00	0664-03	0142-00
•• 6DD3-270E-FSD	1661-26	1661-25	0600-00	0616-00	0664-03	0140-00
•• 6DD3-270E-TSE	1661-26	1661-25	0600-00	0616-00	0664-03	0140-00
•• 6DD3-270E-TSK	1661-26	1661-25	0600-00	0616-00	0664-03	0142-00
• 6DE1-3000-ES8	1661-26	1661-25	0600-00	0616-00	0664-05	0141-00
• 6DE1-3000-TSK	1661-26	1661-25	0600-00	0616-00	0664-05	0142-00
• 6DE3-3000-FSD	1661-26	1661-25	0600-00	0616-00	0664-05	0140-00
• 6DE3-3000-TSE	1661-26	1661-25	0600-00	0616-00	0664-05	0140-00

- 1 Bank Unloading
- 2 Banks Unloading

6D, 6R and 6T – Semi-Hermetic Compressors

6D Floating Reed Models - Compressor Parts

Model	Valve Plate Kit	Unloader Valve Plate Kit	Cylinder Head Gasket	Unloader Cylinder Head Gasket	Valve Plate Gasket	Terminal Plate Group
	(998-)	(998-)	(020-)	(020-)	(020-)	(521-)
• 6DE3-3000-TSK	1661-26	1661-25	0600-00	0616-00	0664-05	0142-00
• 6DE3-300E-FSD	1661-26	1661-25	0600-00	0616-00	0664-05	0140-00
• 6DE3-300E-TSE	1661-26	1661-25	0600-00	0616-00	0664-05	0140-00
• 6DE3-300E-TSK	1661-26	1661-25	0600-00	0616-00	0664-05	0142-00
•• 6DF1-3000-ES8	1661-26	1661-25	0600-00	0616-00	0664-05	0141-00
•• 6DF1-3000-FSD	1661-26	1661-25	0600-00	0616-00	0664-05	0140-00
•• 6DF1-3000-TSK	1661-26	1661-25	0600-00	0616-00	0664-05	0142-00
•• 6DF3-3000-FSD	1661-26	1661-25	0600-00	0616-00	0664-05	0140-00
•• 6DF3-3000-TSE	1661-26	1661-25	0600-00	0616-00	0664-05	0140-00
•• 6DF3-3000-TSK	1661-26	1661-25	0600-00	0616-00	0664-05	0142-00
•• 6DF3-300E-FSD	1661-26	1661-25	0600-00	0616-00	0664-05	0140-00
•• 6DF3-300E-TSE	1661-26	1661-25	0600-00	0616-00	0664-05	0140-00
•• 6DF3-300E-TSK	1661-26	1661-25	0600-00	0616-00	0664-05	0142-00
6DG3-3500-FSD	1661-27		0600-00		0664-15	0140-01
6DG3-3500-FSU	1661-27		0600-00		0664-15	0140-01
6DG3-3500-TSE	1661-27		0600-00		0664-15	0140-01
6DG3-3500-TSN	1661-27		0600-00		0664-15	0142-01
6DG3-350E-FSD	1661-27		0600-00		0664-15	0140-01
6DG3-350E-FSU	1661-27		0600-00		0664-15	0140-01
6DG3-350E-TSE	1661-27		0600-00		0664-15	0140-01
6DG3-350E-TSN	1661-27		0600-00		0664-15	0142-01
6DH1-2000-FSD	1661-26		0600-00		0664-03	0140-00
6DH1-2000-TSE	1661-26		0600-00		0664-03	0140-00
6DH1-2000-TSK	1661-26		0600-00		0664-03	0142-00
6DH1-3500-ES8	1661-27		0600-00		0664-03	0141-01
6DH1-3500-FSD	1661-27		0600-00		0664-03	0140-01
6DH1-3500-TSE	1661-27		0600-00		0664-03	0140-01
6DH1-3500-TSK	1661-27		0600-00		0664-03	0142-01
6DH3-200E-FSM	1661-26		0600-00		0664-03	0140-00
6DH3-200E-TSE	1661-26		0600-00		0664-03	0140-00
6DH3-200E-TSK	1661-26		0600-00		0664-03	0142-00
6DH3-3500-FSD	1661-27		0600-00		0664-03	0140-01
6DH3-3500-TSE	1661-27		0600-00		0664-03	0140-01
6DH3-3500-TSK	1661-27		0600-00		0664-03	0142-01

- 1 Bank Unloading
- 2 Banks Unloading

Semi-Hermetic Compressors – 6D, 6R and 6T

6D Floating Reed Models - Compressor Parts

Model	Valve Plate Kit	Unloader Valve Plate Kit	Cylinder Head Gasket	Unloader Cylinder Head Gasket	Valve Plate Gasket	Terminal Plate Group
	(998-)	(998-)	(020-)	(020-)	(020-)	(521-)
6DH3-350E-FSD	1661-27		0600-00		0664-03	0140-01
6DH3-350E-TSE	1661-27		0600-00		0664-03	0140-01
6DH3-350E-TSK	1661-27		0600-00		0664-03	0142-01
6DJ1-4000-FSD	1661-27		0600-00		0644-05	0140-01
6DJ1-4000-FSU	1661-27		0600-00		0644-05	0140-01
6DJ1-4000-TSE	1661-27		0600-00		0644-05	0140-01
6DJ1-4000-TSN	1661-27		0600-00		0644-05	0142-01
6DJ3-300E-TSE	1661-27		0600-00		0644-05	0140-00
6DJ3-300E-TSK	1661-27		0600-00		0644-05	0142-00
6DJ3-4000-FSD	1661-27		0600-00		0644-05	0140-01
6DJ3-4000-FSU	1661-27		0600-00		0644-05	0140-01
6DJ3-4000-TSE	1661-27		0600-00		0644-05	0140-01
6DJ3-4000-TSN	1661-27		0600-00		0644-05	0142-01
6DJ3-400E-FSD	1661-27		0600-00		0644-05	0140-01
6DJ3-400E-FSU	1661-27		0600-00		0644-05	0140-01
6DJ3-400E-TSE	1661-27		0600-00		0644-05	0140-01
6DJ3-400E-TSN	1661-27		0600-00		0644-05	0142-01
• 6DK1-2000-TSK	1661-27	1661-25	0600-00	0616-00	0664-03	0142-00
• 6DK1-3500-FSD	1661-27	1661-28	0600-00	0616-00	0664-03	0140-01
• 6DK1-3500-TSE	1661-27	1661-28	0600-00	0616-00	0664-03	0140-01
• 6DK1-3500-TSK	1661-27	1661-28	0600-00	0616-00	0664-03	0142-01
• 6DK1-350E-TSK	1661-27	1661-28	0600-00	0616-00	0664-03	0142-01
• 6DK3-200E-FSM	1661-26	1661-25	0600-00	0616-00	0664-03	0140-00
• 6DK3-200E-TSE	1661-26	1661-25	0600-00	0616-00	0664-03	0140-00
• 6DK3-200E-TSK	1661-26	1661-25	0600-00	0616-00	0664-03	0142-00
• 6DK3-3500-FSD	1661-27	1661-28	0600-00	0616-00	0664-03	0140-01
• 6DK3-3500-TSE	1661-27	1661-28	0600-00	0616-00	0664-03	0140-01
• 6DK3-3500-TSK	1661-27	1661-28	0600-00	0616-00	0664-03	0142-01
• 6DK3-350E-FSD	1661-27	1661-28	0600-00	0616-00	0664-03	0140-01
• 6DK3-350E-TSE	1661-27	1661-28	0600-00	0616-00	0664-03	0140-01
• 6DK3-350E-TSK	1661-27	1661-28	0600-00	0616-00	0664-03	0142-01
6DL1-2700-FSD	1661-26	1661-25	0600-00	0616-00	0664-03	0140-00
6DL1-2700-TSE	1661-26	1661-25	0600-00	0616-00	0664-03	0140-00
6DL1-2700-TSK	1661-26	1661-25	0600-00	0616-00	0664-03	0142-00

- 1 Bank Unloading
- 2 Banks Unloading

6D, 6R and 6T – Semi-Hermetic Compressors

6D Floating Reed Models - Compressor Parts

Model	Valve Plate Kit	Unloader Valve Plate Kit	Cylinder Head Gasket	Unloader Cylinder Head Gasket	Valve Plate Gasket	Terminal Plate Group
	(998-)	(998-)	(020-)	(020-)	(020-)	(521-)
6DL3-2700-FSD	1661-26	1661-25	0600-00	0616-00	0664-03	0140-00
6DL3-2700-TSE	1661-26	1661-25	0600-00	0616-00	0664-03	0140-00
6DL3-2700-TSK	1661-26	1661-25	0600-00	0616-00	0664-03	0142-00
6DL3-270E-FSD	1661-26	1661-25	0600-00	0616-00	0664-03	0140-00
6DL3-270E-TSE	1661-26	1661-25	0600-00	0616-00	0664-03	0140-00
6DL3-270E-TSK	1661-26	1661-25	0600-00	0616-00	0664-03	0142-00
• 6DM3-3500-FSD	1661-27	1661-28	0600-00	0616-00	0664-15	0140-01
• 6DM3-3500-FSU	1661-27	1661-28	0600-00	0616-00	0664-15	0140-01
• 6DM3-3500-TSE	1661-27	1661-28	0600-00	0616-00	0664-15	0140-01
• 6DM3-3500-TSN	1661-27	1661-28	0600-00	0616-00	0664-15	0142-01
• 6DM3-350E-FSD	1661-27	1661-28	0600-00	0616-00	0664-15	0140-01
• 6DM3-350E-FSU	1661-27	1661-28	0600-00	0616-00	0664-15	0140-01
• 6DM3-350E-TSE	1661-27	1661-28	0600-00	0616-00	0664-15	0140-01
• 6DM3-350E-TSN	1661-27	1661-28	0600-00	0616-00	0664-15	0142-01
•• 6DN3-3500-ES8	1661-27	1661-28	0600-00	0616-00	0664-15	0141-01
•• 6DN3-3500-FSD	1661-27	1661-28	0600-00	0616-00	0664-15	0140-01
•• 6DN3-3500-FSU	1661-27	1661-28	0600-00	0616-00	0664-15	0140-01
•• 6DN3-3500-TSE	1661-27	1661-28	0600-00	0616-00	0664-15	0140-01
•• 6DN3-3500-TSN	1661-27	1661-28	0600-00	0616-00	0664-15	0142-01
•• 6DN3-350E-FSD	1661-27	1661-28	0600-00	0616-00	0664-15	0140-01
•• 6DN3-350E-FSU	1661-27	1661-28	0600-00	0616-00	0664-15	0140-01
•• 6DN3-350E-TSE	1661-27	1661-28	0600-00	0616-00	0664-15	0140-01
•• 6DN3-350E-TSN	1661-27	1661-28	0600-00	0616-00	0664-15	0142-01
•• 6DP1-2000-TSK	1661-27	1661-28	0600-00	0616-00	0664-03	0142-00
•• 6DP1-3500-FSD	1661-27	1661-28	0600-00	0616-00	0664-03	0140-01
•• 6DP1-3500-TSE	1661-27	1661-28	0600-00	0616-00	0664-03	0140-01
•• 6DP1-3500-TSK	1661-27	1661-28	0600-00	0616-00	0664-03	0141-01
•• 6DP1-350E-TSK	1661-27	1661-28	0600-00	0616-00	0664-03	0141-01
•• 6DP3-200E-FSM	1661-26	1661-28	0600-00	0616-00	0664-03	0140-00
•• 6DP3-200E-TSE	1661-27	1661-28	0600-00	0616-00	0664-03	0140-00
•• 6DP3-200E-TSK	1661-27	1661-28	0600-00	0616-00	0664-03	0142-00
•• 6DP3-3500-FSD	1661-27	1661-28	0600-00	0616-00	0664-03	0140-01
•• 6DP3-3500-TSE	1661-27	1661-28	0600-00	0616-00	0664-03	0140-01
•• 6DP3-3500-TSK	1661-27	1661-28	0600-00	0616-00	0664-03	0142-01

• 1 Bank Unloading
•• 2 Banks Unloading

Semi-Hermetic Compressors – 6D, 6R and 6T

6D Floating Reed Models - Compressor Parts

Model	Valve Plate Kit	Unloader Valve Plate Kit	Cylinder Head Gasket	Unloader Cylinder Head Gasket	Valve Plate Gasket	Terminal Plate Group
	(998-)	(998-)	(020-)	(020-)	(020-)	(521-)
•• 6DP3-350E-FSD	1661-27	1661-28	0600-00	0616-00	0664-03	0140-01
•• 6DP3-350E-TSE	1661-27	1661-28	0600-00	0616-00	0664-03	0140-01
•• 6DP3-350E-TSK	1661-27	1661-28	0600-00	0616-00	0664-03	0142-01
• 6DR1-4000-FSD	1661-27	1661-28	0600-00	0616-00	0664-05	0140-01
• 6DR1-4000-FSU	1661-27	1661-28	0600-00	0616-00	0664-05	0140-01
• 6DR1-4000-TSE	1661-27	1661-28	0600-00	0616-00	0664-05	0140-01
• 6DR1-4000-TSN	1661-27	1661-28	0600-00	0616-00	0664-05	0142-01
• 6DR3-300E-TSE	1661-27	1661-28	0600-00	0616-00	0664-05	0140-01
• 6DR3-300E-TSK	1661-27	1661-28	0600-00	0616-00	0664-05	0142-01
• 6DR3-4000-FSD	1661-27	1661-28	0600-00	0616-00	0664-05	0140-01
• 6DR3-4000-FSU	1661-27	1661-28	0600-00	0616-00	0664-05	0140-01
• 6DR3-4000-TSE	1661-27	1661-28	0600-00	0616-00	0664-05	0140-01
• 6DR3-4000-TSN	1661-27	1661-28	0600-00	0616-00	0664-05	0142-01
• 6DR3-400E-FSD	1661-27	1661-28	0600-00	0616-00	0664-05	0140-01
• 6DR3-400E-FSU	1661-27	1661-28	0600-00	0616-00	0664-05	0140-01
• 6DR3-400E-TSE	1661-27	1661-28	0600-00	0616-00	0664-05	0140-01
• 6DR3-400E-TSN	1661-27	1661-28	0600-00	0616-00	0664-05	0142-01
•• 6DS1-4000-ES8	1661-27	1661-28	0600-00	0616-00	0664-05	0141-01
•• 6DS1-4000-FSD	1661-27	1661-28	0600-00	0616-00	0664-05	0140-01
•• 6DS1-4000-FSU	1661-27	1661-28	0600-00	0616-00	0664-05	0140-01
•• 6DS1-4000-TSE	1661-27	1661-28	0600-00	0616-00	0664-05	0140-01
•• 6DS1-4000-TSN	1661-27	1661-28	0600-00	0616-00	0664-05	0142-01
•• 6DS3-300E-TSE	1661-27	1661-28	0600-00	0616-00	0664-05	0140-00
•• 6DS3-300E-TSK	1661-27	1661-28	0600-00	0616-00	0664-05	0142-00
•• 6DS3-4000-FSD	1661-27	1661-28	0600-00	0616-00	0664-05	0140-01
•• 6DS3-4000-FSU	1661-27	1661-28	0600-00	0616-00	0664-05	0140-01
•• 6DS3-4000-TSE	1661-27	1661-28	0600-00	0616-00	0664-05	0140-01
•• 6DS3-4000-TSN	1661-27	1661-28	0600-00	0616-00	0664-05	0142-01
•• 6DS3-400E-FSD	1661-27	1661-28	0600-00	0616-00	0664-05	0140-01
•• 6DS3-400E-FSU	1661-27	1661-28	0600-00	0616-00	0664-05	0140-01
•• 6DS3-400E-TSE	1661-27	1661-28	0600-00	0616-00	0664-05	0140-01
•• 6DS3-400E-TSN	1661-27	1661-28	0600-00	0616-00	0664-05	0140-01
6DT1-3000-ES8	1661-26		0600-00		0664-05	0141-00
6DT1-3000-FSD	1661-26		0600-00		0664-05	0140-00

- 1 Bank Unloading
- 2 Banks Unloading

6D, 6R and 6T – Semi-Hermetic Compressors

6D Floating Reed Models - Compressor Parts

Model	Valve Plate Kit	Unloader Valve Plate Kit	Cylinder Head Gasket	Unloader Cylinder Head Gasket	Valve Plate Gasket	Terminal Plate Group
	(998-)	(998-)	(020-)	(020-)	(020-)	(521-)
6DT1-3000-TSE	1661-26		0600-00		0664-05	0140-00
6DT1-3000-TSK	1661-26		0600-00		0664-05	0142-00
6DT3-3000-FSD	1661-26		0600-00		0664-05	0140-00
6DT3-3000-TSE	1661-26		0600-00		0664-05	0140-00
6DT3-3000-TSK	1661-26		0600-00		0664-05	0142-00
6DT3-300E-FSD	1661-26		0600-00		0664-05	0140-00
6DT3-300E-TSE	1661-26		0600-00		0664-05	0140-00
6DT3-300E-TSK	1661-26		0600-00		0664-05	0142-00
• 6DW3-3000-FSD	1661-27	1661-28	0600-00	0616-00	0664-03	0140-01
• 6DW3-3000-TSE	1661-27	1661-28	0600-00	0616-00	0664-03	0140-01
• 6DW3-3000-TSK	1661-27	1661-28	0600-00	0616-00	0664-03	0142-01
• 6DW3-300E-FSD	1661-27	1661-28	0600-00	0616-00	0664-03	0140-01
• 6DW3-300E-TSE	1661-27	1661-28	0600-00	0616-00	0664-03	0140-01
• 6DW3-300E-TSK	1661-27	1661-28	0600-00	0616-00	0664-03	0142-01
•• 6DY3-3000-FSD	1661-27	1661-28	0600-00	0616-00	0664-03	0140-01
•• 6DY3-3000-TSE	1661-27	1661-28	0600-00	0616-00	0664-03	0140-01
•• 6DY3-3000-TSK	1661-27	1661-28	0600-00	0616-00	0664-03	0142-01
•• 6DY3-300E-FSD	1661-27	1661-28	0600-00	0616-00	0664-03	0140-01
•• 6DY3-300E-TSE	1661-27	1661-28	0600-00	0616-00	0664-03	0140-01
•• 6DY3-300E-TSK	1661-27	1661-28	0600-00	0616-00	0664-03	0142-01

• 1 Bank Unloading
 •• 2 Banks Unloading

Semi-Hermetic Compressors – 6D, 6R and 6T

6D Delta Reed Models - Compressor Parts

Model (Horse Power Nomenclature)	New Model (BTU Nomenclature)	Delta Valve Plate Kit	Unloader Valve Plate Kit	Cylinder Head Gasket	Unloader Cylinder Head Gasket	Valve Plate Gasket	Terminal Plate Group
		(998-)	(998-)	(020-)	(020-)	(020-)	(521-)
6DB3A3000-FSD	6DB3R32M0-FSD	2661-27		0600-00		1235-01	0140-01
6DB3A3000-TSE	6DB3R32M0-TSE	2661-27		0600-00		1235-01	0140-01
6DB3A3000-TSK	6DB3R32M0-TSK	2661-27		0600-00		1235-01	0142-01
6DB3A300E-FSD	6DB3R32ME-FSD	2661-27		0600-00		1235-01	0140-01
6DB3A300E-TSE	6DB3R32ME-TSE	2661-27		0600-00		1235-01	0140-01
6DB3A300E-TSK	6DB3R32ME-TSK	2661-27		0600-00		1235-01	0142-01
• 6DC1A2700-TSE	N/A	2661-26	2661-25	0600-00	0616-00	1235-01	0140-00
• 6DC1A2700-TSK	N/A	2661-26	2661-25	0600-00	0616-00	1235-01	0142-00
• 6DC3A2700-ES8	N/A	2661-26	2661-25	0600-00	0616-00	1235-01	0141-00
• 6DC3A2700-FSD	6DC3F93K0-FSD	2661-26	2661-25	0600-00	0616-00	1235-01	0140-00
• 6DC3A2700-TSE	6DC3F93K0-TSE	2661-26	2661-25	0600-00	0616-00	1235-01	0140-00
• 6DC3A2700-TSK	6DC3F93K0-TSK	2661-26	2661-25	0600-00	0616-00	1235-01	0142-00
• 6DC3A270E-FSD	6DC3F93KE-FSD	2661-26	2661-25	0600-00	0616-00	1235-01	0140-00
• 6DC3A270E-TSE	6DC3F93KE-TSE	2661-26	2661-25	0600-00	0616-00	1235-01	0140-00
• 6DC3A270E-TSK	6DC3F93KE-TSK	2661-26	2661-25	0600-00	0616-00	1235-01	0142-00
•• 6DD1A2700-FSD	N/A	2661-26	2661-25	0600-00	0616-00	1235-01	0140-00
•• 6DD1A2700-TSK	N/A	2661-26	2661-25	0600-00	0616-00	1235-01	0142-00
•• 6DD3A2700-ES8	N/A	2661-26	2661-25	0600-00	0616-00	1235-01	0141-00
•• 6DD3A2700-FSD	6DD3F93K0-FSD	2661-26	2661-25	0600-00	0616-00	1235-01	0140-00
•• 6DD3A2700-TSE	6DD3F93K0-TSE	2661-26	2661-25	0600-00	0616-00	1235-01	0140-00
•• 6DD3A2700-TSK	6DD3F93K0-TSK	2661-26	2661-25	0600-00	0616-00	1235-01	0142-00
•• 6DD3A270E-FSD	6DD3F93KE-FSD	2661-26	2661-25	0600-00	0616-00	1235-01	0140-00
•• 6DD3A270E-TSE	6DD3F93KE-TSE	2661-26	2661-25	0600-00	0616-00	1235-01	0140-00
•• 6DD3A270E-TSK	6DD3F93KE-TSK	2661-26	2661-25	0600-00	0616-00	1235-01	0142-00
• 6DE1A3000-ES8	N/A	2661-26	2661-25	0600-00	0616-00	1235-03	0141-00
• 6DE1A3000-TSK	N/A	2661-26	2661-25	0600-00	0616-00	1235-03	0142-00
• 6DE3A3000-FSD	6DE3F11M0-FSD	2661-26	2661-25	0600-00	0616-00	1235-03	0140-00
• 6DE3A3000-TSE	6DE3F11M0-TSE	2661-26	2661-25	0600-00	0616-00	1235-03	0140-00
• 6DE3A3000-TSK	6DE3F11M0-TSK	2661-26	2661-25	0600-00	0616-00	1235-03	0142-00
• 6DE3A300E-FSD	6DE3F11ME-FSD	2661-26	2661-25	0600-00	0616-00	1235-03	0140-00
• 6DE3A300E-TSE	6DE3F11ME-TSE	2661-26	2661-25	0600-00	0616-00	1235-03	0140-00
• 6DE3A300E-TSK	6DE3F11ME-TSK	2661-26	2661-25	0600-00	0616-00	1235-03	0142-00
•• 6DF1A3000-ES8	N/A	2661-26	2661-25	0600-00	0616-00	1235-03	0141-00
•• 6DF1A3000-FSD	N/A	2661-26	2661-25	0600-00	0616-00	1235-03	0140-00
•• 6DF1A3000-TSK	N/A	2661-26	2661-25	0600-00	0616-00	1235-03	0142-00
•• 6DF3A3000-FSD	6DF3F11M0-FSD	2661-26	2661-25	0600-00	0616-00	1235-03	0140-00

New Model Nomenclature (5th Digit = Application Rating)

R = Rating at +45°F to +130°F at 90°F Ambient Air

S = Rating at +20°F to +120°F at 90°F Ambient Air

F = Rating at -25°F to +105°F at 90° Ambient Air

- 1 Bank Unloading
- 2 Banks Unloading

6D, 6R and 6T – Semi-Hermetic Compressors

6D Delta Reed Models - Compressor Parts

Model (Horse Power Nomenclature)	New Model (BTU Nomenclature)	Delta Valve Plate Kit	Unloader Valve Plate Kit	Cylinder Head Gasket	Unloader Cylinder Head Gasket	Valve Plate Gasket	Terminal Plate Group
		(998-)	(998-)	(020-)	(020-)	(020-)	(521-)
•• 6DF3A3000-TSE	6DF3F11M0-TSE	2661-26	2661-25	0600-00	0616-00	1235-03	0140-00
•• 6DF3A3000-TSK	6DF3F11M0-TSK	2661-26	2661-25	0600-00	0616-00	1235-03	0142-00
•• 6DF3A300E-FSD	6DF3F11ME-FSD	2661-26	2661-25	0600-00	0616-00	1235-03	0140-00
•• 6DF3A300E-TSE	6DF3F11ME-TSE	2661-26	2661-25	0600-00	0616-00	1235-03	0140-00
•• 6DF3A300E-TSK	6DF3F11ME-TSK	2661-26	2661-25	0600-00	0616-00	1235-03	0142-00
6DG3A3500-FSD	6DG3R37M0-FSD	2661-27		0600-00		1235-07	0140-01
6DG3A3500-FSU	6DG3R37M0-FSU	2661-27		0600-00		1235-07	0140-01
6DG3A3500-TSE	6DG3R37M0-TSE	2661-27		0600-00		1235-07	0140-01
6DG3A3500-TSN	6DG3R37M0-TSN	2661-27		0600-00		1235-07	0142-01
6DG3A350E-FSD	6DG3R37ME-FSD	2661-27		0600-00		1235-07	0140-01
6DG3A350E-FSU	6DG3R37ME-FSU	2661-27		0600-00		1235-07	0140-01
6DG3A350E-TSE	6DG3R37ME-TSE	2661-27		0600-00		1235-07	0140-01
6DG3A350E-TSN	6DG3R37ME-TSN	2661-27		0600-00		1235-07	0142-01
6DH1A2000-FSD	N/A	2661-26		0600-00		1235-01	0140-00
6DH1A2000-TSE	N/A	2661-26		0600-00		1235-01	0140-00
6DH1A2000-TSK	N/A	2661-26		0600-00		1235-01	0142-00
6DH1A3500-FSD	6DH1R35M0-FSD	2661-27		0600-00		1235-01	0140-01
6DH1A3500-TSE	6DH1R35M0-TSE	2661-27		0600-00		1235-01	0140-01
6DH1A3500-TSK	6DH1R35M0-TSK	2661-27		0600-00		1235-01	0142-01
6DH3A200E-FSM	6DH3R23ME-FSM	2661-26		0600-00		1235-01	0140-00
6DH3A200E-TSE	6DH3R23ME-TSE	2661-26		0600-00		1235-01	0140-00
6DH3A200E-TSK	6DH3R23ME-TSK	2661-26		0600-00		1235-01	0142-00
6DH3A3500-FSD	6DH3R35M0-FSD	2661-27		0600-00		1235-01	0140-01
6DH3A3500-TSE	6DH3R35M0-TSE	2661-27		0600-00		1235-01	0140-01
6DH3A3500-TSK	6DH3R35M0-TSK	2661-27		0600-00		1235-01	0142-01
6DH3A350E-FSD	6DH3R35ME-FSD	2661-27		0600-00		1235-01	0140-01
6DH3A350E-TSE	6DH3R35ME-TSE	2661-27		0600-00		1235-01	0140-01
6DH3A350E-TSK	6DH3R35ME-TSK	2661-27		0600-00		1235-01	0142-01
6DJ1A4000-FSD	6DJ1R40M0-FSD	2661-27		0600-00		1235-03	0140-01
6DJ1A4000-FSU	6DJ1R40M0-FSU	2661-27		0600-00		1235-03	0140-01
6DJ1A4000-TSE	6DJ1R40M0-TSE	2661-27		0600-00		1235-03	0140-01
6DJ1A4000-TSN	6DJ1R40M0-TSN	2661-27		0600-00		1235-03	0142-01
6DJ3A300E-TSE	6DJ3R28ME-TSE	2661-27		0600-00		1235-03	0140-00
6DJ3A300E-TSK	6DJ3R28ME-TSK	2661-27		0600-00		1235-03	0142-00
6DJ3A4000-FSD	6DJ3R40M0-FSD	2661-27		0600-00		1235-03	0140-01
6DJ3A4000-FSU	6DJ3R40M0-FSU	2661-27		0600-00		1235-03	0140-01

New Model Nomenclature (5th Digit = Application Rating)

R = Rating at +45°F to +130°F at 90°F Ambient Air

S = Rating at +20°F to +120°F at 90°F Ambient Air

F = Rating at -25°F to +105°F at 90° Ambient Air

- 1 Bank Unloading
- 2 Banks Unloading

Semi-Hermetic Compressors – 6D, 6R and 6T

6D Delta Reed Models - Compressor Parts

Model (Horse Power Nomenclature)	New Model (BTU Nomenclature)	Delta Valve Plate Kit	Unloader Valve Plate Kit	Cylinder Head Gasket	Unloader Cylinder Head Gasket	Valve Plate Gasket	Terminal Plate Group
		(998-)	(998-)	(020-)	(020-)	(020-)	(521-)
6DJ3A4000-TSE	6DJ3R40M0-TSE	2661-27		0600-00		1235-03	0140-01
6DJ3A4000-TSN	6DJ3R40M0-TSN	2661-27		0600-00		1235-03	0142-01
6DJ3A400E-FSD	6DJ3R40ME-FSD	2661-27		0600-00		1235-03	0140-01
6DJ3A400E-FSU	6DJ3R40ME-FSU	2661-27		0600-00		1235-03	0140-01
6DJ3A400E-TSE	6DJ3R40ME-TSE	2661-27		0600-00		1235-03	0140-01
6DJ3A400E-TSN	6DJ3R40ME-TSN	2661-27		0600-00		1235-03	0142-01
• 6DK1A2000-TSK	N/A	2661-27	2661-25	0600-00	0616-00	1235-01	0142-00
• 6DK1A3500-ES8	6DK1R35M0-ES8	2661-27	2661-28	0600-00	0616-00	1235-01	0141-01
• 6DK1A3500-FSD	6DK1R35M0-FSD	2661-27	2661-28	0600-00	0616-00	1235-01	0140-01
• 6DK1A3500-TSE	6DK1R35M0-TSE	2661-27	2661-28	0600-00	0616-00	1235-01	0140-01
• 6DK1A3500-TSK	6DK1R35M0-TSK	2661-27	2661-28	0600-00	0616-00	1235-01	0142-01
• 6DK1A350E-TSK	6DK1R35ME-TSK	2661-27	2661-28	0600-00	0616-00	1235-01	0142-01
• 6DK3A200E-FSM	6DK3R23ME-FSM	2661-26	2661-25	0600-00	0616-00	1235-01	0140-00
• 6DK3A200E-TSE	6DK3R23ME-TSE	2661-26	2661-25	0600-00	0616-00	1235-01	0140-00
• 6DK3A200E-TSK	6DK3R23ME-TSK	2661-26	2661-25	0600-00	0616-00	1235-01	0142-00
• 6DK3A3500-FSD	6DK3R35M0-FSD	2661-27	2661-28	0600-00	0616-00	1235-01	0140-01
• 6DK3A3500-TSE	6DK3R35M0-TSE	2661-27	2661-28	0600-00	0616-00	1235-01	0140-01
• 6DK3A3500-TSK	6DK3R35M0-TSK	2661-27	2661-28	0600-00	0616-00	1235-01	0142-01
• 6DK3A350E-FSD	6DK3R35ME-FSD	2661-27	2661-28	0600-00	0616-00	1235-01	0140-01
• 6DK3A350E-TSE	6DK3R35ME-TSE	2661-27	2661-28	0600-00	0616-00	1235-01	0140-01
• 6DK3A350E-TSK	6DK3R35ME-TSK	2661-27	2661-28	0600-00	0616-00	1235-01	0142-01
6DL1A2700-FSD	N/A	2661-26	2661-25	0600-00	0616-00	1235-01	0140-00
6DL1A2700-TSE	N/A	2661-26	2661-25	0600-00	0616-00	1235-01	0140-00
6DL1A2700-TSK	N/A	2661-26	2661-25	0600-00	0616-00	1235-01	0142-00
6DL3A2700-ES8	N/A	2661-26	2661-25	0600-00	0616-00	1235-01	0141-00
6DL3A2700-FSD	6DL3F93K0-FSD	2661-26	2661-25	0600-00	0616-00	1235-01	0140-00
6DL3A2700-TSE	6DL3F93K0-TSE	2661-26	2661-25	0600-00	0616-00	1235-01	0140-00
6DL3A2700-TSK	6DL3F93K0-TSK	2661-26	2661-25	0600-00	0616-00	1235-01	0142-00
6DL3A270E-FSD	6DL3F93KE-FSD	2661-26	2661-25	0600-00	0616-00	1235-01	0140-00
6DL3A270E-TSE	6DL3F93KE-TSE	2661-26	2661-25	0600-00	0616-00	1235-01	0140-00
6DL3A270E-TSK	6DL3F93KE-TSK	2661-26	2661-25	0600-00	0616-00	1235-01	0142-00
• 6DM3A3500-FSD	6DM3R37M0-FSD	2661-27	2661-28	0600-00	0616-00	1235-07	0140-01
• 6DM3A3500-FSU	6DM3R37M0-FSU	2661-27	2661-28	0600-00	0616-00	1235-07	0140-01
• 6DM3A3500-TSE	6DM3R37M0-TSE	2661-27	2661-28	0600-00	0616-00	1235-07	0140-01
• 6DM3A3500-TSN	6DM3R37M0-TSN	2661-27	2661-28	0600-00	0616-00	1235-07	0142-01
• 6DM3A350E-FSD	6DM3R37ME-FSD	2661-27	2661-28	0600-00	0616-00	1235-07	0140-01

New Model Nomenclature (5th Digit = Application Rating)

R = Rating at +45°F to +130°F at 90°F Ambient Air

S = Rating at +20°F to +120°F at 90°F Ambient Air

F = Rating at -25°F to +105°F at 90° Ambient Air

- 1 Bank Unloading
- 2 Banks Unloading

6D, 6R and 6T – Semi-Hermetic Compressors

6D Delta Reed Models - Compressor Parts

Model (Horse Power Nomenclature)	New Model (BTU Nomenclature)	Delta Valve Plate Kit	Unloader Valve Plate Kit	Cylinder Head Gasket	Unloader Cylinder Head Gasket	Valve Plate Gasket	Terminal Plate Group
		(998-)	(998-)	(020-)	(020-)	(020-)	(521-)
• 6DM3A350E-FSU	6DM3R37ME-FSU	2661-27	2661-28	0600-00	0616-00	1235-07	0140-01
• 6DM3A350E-TSE	6DM3R37ME-TSE	2661-27	2661-28	0600-00	0616-00	1235-07	0140-01
• 6DM3A350E-TSN	6DM3R37ME-TSN	2661-27	2661-28	0600-00	0616-00	1235-07	0142-01
•• 6DN3A3500-FSD	6DN3R37M0-FSD	2661-27	2661-28	0600-00	0616-00	1235-07	0140-01
•• 6DN3A3500-FSU	6DN3R37M0-FSU	2661-27	2661-28	0600-00	0616-00	1235-07	0140-01
•• 6DN3A3500-TSE	6DN3R37M0-TSE	2661-27	2661-28	0600-00	0616-00	1235-07	0140-01
•• 6DN3A3500-TSN	6DN3R37M0-TSN	2661-27	2661-28	0600-00	0616-00	1235-07	0142-01
•• 6DN3A350E-FSD	6DN3R37ME-FSD	2661-27	2661-28	0600-00	0616-00	1235-07	0140-01
•• 6DN3A350E-FSU	6DN3R37ME-FSU	2661-27	2661-28	0600-00	0616-00	1235-07	0140-01
•• 6DN3A350E-TSE	6DN3R37ME-TSE	2661-27	2661-28	0600-00	0616-00	1235-07	0140-01
•• 6DN3A350E-TSN	6DN3R37ME-TSN	2661-27	2661-28	0600-00	0616-00	1235-07	0142-01
•• 6DP1A2000-TSK	N/A	2661-27	2661-28	0600-00	0616-00	1235-01	0142-00
•• 6DP1A3500-FSD	6DP1R35M0-FSD	2661-27	2661-28	0600-00	0616-00	1235-01	0140-01
•• 6DP1A3500-TSE	6DP1R35M0-TSE	2661-27	2661-28	0600-00	0616-00	1235-01	0140-01
•• 6DP1A3500-TSK	6DP1R35M0-TSK	2661-27	2661-28	0600-00	0616-00	1235-01	0141-01
•• 6DP1A350E-TSK	6DP1R35ME-TSK	2661-27	2661-28	0600-00	0616-00	1235-01	0141-01
•• 6DP3A200E-FSM	6DP3R23ME-FSM	2661-26	2661-28	0600-00	0616-00	1235-01	0140-00
•• 6DP3A200E-TSE	6DP3R23ME-TSE	2661-27	2661-28	0600-00	0616-00	1235-01	0140-00
•• 6DP3A200E-TSK	6DP3R23ME-TSK	2661-27	2661-28	0600-00	0616-00	1235-01	0142-00
•• 6DP3A3500-FSD	6DP3R35M0-FSD	2661-27	2661-28	0600-00	0616-00	1235-01	0140-01
•• 6DP3A3500-TSE	6DP3R35M0-TSE	2661-27	2661-28	0600-00	0616-00	1235-01	0140-01
•• 6DP3A3500-TSK	6DP3R35M0-TSK	2661-27	2661-28	0600-00	0616-00	1235-01	0142-01
•• 6DP3A350E-FSD	6DP3R35ME-FSD	2661-27	2661-28	0600-00	0616-00	1235-01	0140-01
•• 6DP3A350E-TSE	6DP3R35ME-TSE	2661-27	2661-28	0600-00	0616-00	1235-01	0140-01
•• 6DP3A350E-TSK	6DP3R35ME-TSK	2661-27	2661-28	0600-00	0616-00	1235-01	0142-01
• 6DR1A4000-FSD	6DR1R40M0-FSD	2661-27	2661-28	0600-00	0616-00	1235-03	0140-01
• 6DR1A4000-FSU	6DR1R40M0-FSU	2661-27	2661-28	0600-00	0616-00	1235-03	0140-01
• 6DR1A4000-TSE	6DR1R40M0-TSE	2661-27	2661-28	0600-00	0616-00	1235-03	0140-01
• 6DR1A4000-TSN	6DR1R40M0-TSN	2661-27	2661-28	0600-00	0616-00	1235-03	0142-01
• 6DR3A300E-TSE	6DR3R28ME-TSE	2661-27	2661-28	0600-00	0616-00	1235-03	0140-01
• 6DR3A300E-TSK	6DR3R28ME-TSK	2661-27	2661-28	0600-00	0616-00	1235-03	0142-01
• 6DR3A4000-FSD	6DR3R40M0-FSD	2661-27	2661-28	0600-00	0616-00	1235-03	0140-01
• 6DR3A4000-FSU	6DR3R40M0-FSU	2661-27	2661-28	0600-00	0616-00	1235-03	0140-01
• 6DR3A4000-TSE	6DR3R40M0-TSE	2661-27	2661-28	0600-00	0616-00	1235-03	0140-01
• 6DR3A4000-TSN	6DR3R40M0-TSN	2661-27	2661-28	0600-00	0616-00	1235-03	0142-01
• 6DR3A400E-FSD	6DR3R40ME-FSD	2661-27	2661-28	0600-00	0616-00	1235-03	0140-01

New Model Nomenclature (5th Digit = Application Rating)

R = Rating at +45°F to +130°F at 90°F Ambient Air

S = Rating at +20°F to +120°F at 90°F Ambient Air

F = Rating at -25°F to +105°F at 90° Ambient Air

- 1 Bank Unloading
- 2 Banks Unloading

Semi-Hermetic Compressors – 6D, 6R and 6T

6D Delta Reed Models - Compressor Parts

Model (Horse Power Nomenclature)	New Model (BTU Nomenclature)	Delta Valve Plate Kit	Unloader Valve Plate Kit	Cylinder Head Gasket	Unloader Cylinder Head Gasket	Valve Plate Gasket	Terminal Plate Group
		(998-)	(998-)	(020-)	(020-)	(020-)	(521-)
• 6DR3A400E-FSU	6DR3R40ME-FSU	2661-27	2661-28	0600-00	0616-00	1235-03	0140-01
• 6DR3A400E-TSE	6DR3R40ME-TSE	2661-27	2661-28	0600-00	0616-00	1235-03	0140-01
• 6DR3A400E-TSN	6DR3R40ME-TSN	2661-27	2661-28	0600-00	0616-00	1235-03	0142-01
•• 6DS1A4000-FSD	6DS1R40M0-FSD	2661-27	2661-28	0600-00	0616-00	1235-03	0140-01
•• 6DS1A4000-FSU	6DS1R40M0-FSU	2661-27	2661-28	0600-00	0616-00	1235-03	0140-01
•• 6DS1A4000-TSE	6DS1R40M0-TSE	2661-27	2661-28	0600-00	0616-00	1235-03	0140-01
•• 6DS1A4000-TSN	6DS1R40M0-TSN	2661-27	2661-28	0600-00	0616-00	1235-03	0142-01
•• 6DS3A300E-TSE	6DS3R28ME-TSE	2661-27	2661-28	0600-00	0616-00	1235-03	0140-00
•• 6DS3A300E-TSK	6DS3R28ME-TSK	2661-27	2661-28	0600-00	0616-00	1235-03	0142-00
•• 6DS3A4000-FSD	6DS3R40M0-FSD	2661-27	2661-28	0600-00	0616-00	1235-03	0140-01
•• 6DS3A4000-FSU	6DS3R40M0-FSU	2661-27	2661-28	0600-00	0616-00	1235-03	0140-01
•• 6DS3A4000-TSE	6DS3R40M0-TSE	2661-27	2661-28	0600-00	0616-00	1235-03	0140-01
•• 6DS3A4000-TSN	6DS3R40M0-TSN	2661-27	2661-28	0600-00	0616-00	1235-03	0142-01
•• 6DS3A400E-FSD	6DS3R40ME-FSD	2661-27	2661-28	0600-00	0616-00	1235-03	0140-01
•• 6DS3A400E-FSU	6DS3R40ME-FSU	2661-27	2661-28	0600-00	0616-00	1235-03	0140-01
•• 6DS3A400E-TSE	6DS3R40ME-TSE	2661-27	2661-28	0600-00	0616-00	1235-03	0140-01
•• 6DS3A400E-TSN	6DS3R40ME-TSN	2661-27	2661-28	0600-00	0616-00	1235-03	0140-01
6DT1A3000-FSD	6DT1F11M0-FSD	2661-26		0600-00		1235-03	0140-00
6DT1A3000-TSE	6DT1F11M0-TSE	2661-26		0600-00		1235-03	0140-00
6DT1A3000-TSK	6DT1F11M0-TSK	2661-26		0600-00		1235-03	0142-00
6DT3A3000-FSD	6DT3F11M0-FSD	2661-26		0600-00		1235-03	0140-00
6DT3A3000-TSE	6DT3F11M0-TSE	2661-26		0600-00		1235-03	0140-00
6DT3A3000-TSK	6DT3F11M0-TSK	2661-26		0600-00		1235-03	0142-00
6DT3A300E-FSD	6DT3F11ME-FSD	2661-26		0600-00		1235-03	0140-00
6DT3A300E-TSE	6DT3F11ME-TSE	2661-26		0600-00		1235-03	0140-00
6DT3A300E-TSK	6DT3F11ME-TSK	2661-26		0600-00		1235-03	0142-00
• 6DW3A3000-FSD	6DW3R32M0-FSD	2661-27	2661-28	0600-00	0616-00	1235-01	0140-01
• 6DW3A3000-TSE	6DW3R32M0-TSE	2661-27	2661-28	0600-00	0616-00	1235-01	0140-01
• 6DW3A3000-TSK	6DW3R32M0-TSK	2661-27	2661-28	0600-00	0616-00	1235-01	0142-01
• 6DW3A300E-FSD	6DW3R32ME-FSD	2661-27	2661-28	0600-00	0616-00	1235-01	0140-01
• 6DW3A300E-TSE	6DW3R32ME-TSE	2661-27	2661-28	0600-00	0616-00	1235-01	0140-01
• 6DW3A300E-TSK	6DW3R32ME-TSK	2661-27	2661-28	0600-00	0616-00	1235-01	0142-01
•• 6DY3A3000-FSD	6DY3R32M0-FSD	2661-27	2661-28	0600-00	0616-00	1235-01	0140-01
•• 6DY3A3000-TSE	6DY3R32M0-TSE	2661-27	2661-28	0600-00	0616-00	1235-01	0140-01
•• 6DY3A3000-TSK	6DY3R32M0-TSK	2661-27	2661-28	0600-00	0616-00	1235-01	0142-01
•• 6DY3A300E-FSD	6DY3R32ME-FSD	2661-27	2661-28	0600-00	0616-00	1235-01	0140-01

New Model Nomenclature (5th Digit = Application Rating)

R = Rating at +45°F to +130°F at 90°F Ambient Air

S = Rating at +20°F to +120°F at 90°F Ambient Air

F = Rating at -25°F to +105°F at 90° Ambient Air

- 1 Bank Unloading
- 2 Banks Unloading

6D, 6R and 6T – Semi-Hermetic Compressors

6D Delta Reed Models - Compressor Parts

Model (Horse Power Nomenclature)	New Model (BTU Nomenclature)	Delta Valve Plate Kit	Unloader Valve Plate Kit	Cylinder Head Gasket	Unloader Cylinder Head Gasket	Valve Plate Gasket	Terminal Plate Group
		(998-)	(998-)	(020-)	(020-)	(020-)	(521-)
•• 6DY3A300E-TSE	6DY3R32ME-TSE	2661-27	2661-28	0600-00	0616-00	1235-01	0140-01
•• 6DY3A300E-TSK	6DY3R32ME-TSK	2661-27	2661-28	0600-00	0616-00	1235-01	0142-01

New Model Nomenclature (5th Digit = Application Rating)

R = Rating at +45°F to +130°F at 90°F Ambient Air

S = Rating at +20°F to +120°F at 90°F Ambient Air

F = Rating at -25°F to +105°F at 90° Ambient Air

- 1 Bank Unloading
- 2 Banks Unloading

6D Compressor Capacity Control Kits

Standard Model	Blocked Suction Capacity Control Model (33% Single Bank)	Blocked Suction Capacity Control Model (66% Two Bank)	Capacity Control Conversion Kit with 24V Unloader	Capacity Control Conversion Kit with 120V Unloader	Capacity Control Conversion Kit with 240V Unloader
6DB3A300*	6DW3A300*	6DY3A300*	998-2119-31	998-2119-32	998-2119-33
6DG3A350*	6DM3A350*	6DN3A350*	998-2119-31	998-2119-32	998-2119-33
6DL3A270*	6DC3A270*	6DD3A270*	998-2119-35	998-2119-36	998-2119-37
6DH3A200*	6DK3A200*	6DP3A200*	998-2119-31	998-2119-32	998-2119-33
6DH3A350*	6DK3A350*	6DP3A350*	998-2119-31	998-2119-32	998-2119-33
6DT3A300*	6DE3A300*	6DF3A300*	998-2119-35	998-2119-36	998-2119-37
6DJ3A300*	6DR3A300*	6DS3A300*	998-2119-31	998-2119-32	998-2119-33
6DJ3A400*	6DR3A400*	6DS3A400*	998-2119-31	998-2119-32	998-2119-33
6DB3R32M*	6DW3R32M*	6DY3R32M*	998-2119-31	998-2119-32	998-2119-33
6DG3R37M*	6DM3R37M*	6DN3R37M*	998-2119-31	998-2119-32	998-2119-33
6DL3F93K*	6DC3F93K*	6DD3F93K*	998-2119-35	998-2119-36	998-2119-37
6DH3R23M*	6DK3R23M*	6DP3R23M*	998-2119-31	998-2119-32	998-2119-33
6DH3R35M*	6DK3R35M*	6DP3R35M*	998-2119-31	998-2119-32	998-2119-33
6DT3F11M*	6DE3F11M*	6DSNF11M*	998-2119-35	998-2119-36	998-2119-37
6DJ3R28M*	6DR3R28M*	6DS3R28M*	998-2119-31	998-2119-32	998-2119-33
6DJ3R40M*	6DR3R40M*	6DS3R40M*	998-2119-31	998-2119-32	998-2119-33

* = E (for POE oil models), 0 (for mineral oil models) or L (for less oil models)



Semi-Hermetic Compressors – 6D, 6R and 6T

6R - Compressor Parts

Model	Valve Plate Kit	Complete Gasket Set	Cylinder Head Gasket	Unloader Cylinder Head Gasket	Valve Plate Gasket	Terminal Plate Group
	(998-)	(998-)	(020-)	(020-)	(020-)	(521-)
6RA4-1000-ESL	0661-00	0669-00	0629-00		0626-00	0141-00
6RA4-1000-FSM	0661-00	0669-00	0629-00		0626-00	0140-00
6RA4-1000-TSE	0661-00	0669-00	0629-00		0626-00	0140-00
6RA4-1000-TSK	0661-00	0669-00	0629-00		0626-00	0142-00
6RA4-2000-FSD	0661-00	0669-00	0629-00		0626-00	0140-00
6RA4-2000-TSE	0661-00	0669-00	0629-00		0626-00	0140-00
6RA4-2000-TSK	0661-00	0669-00	0629-00		0626-00	0142-00
6RA4-3000-FSD	0661-52	0669-00	0629-00		0626-00	0140-00
6RA4-3000-TSE	0661-52	0669-00	0629-00		0626-00	0140-00
6RA4-3000-TSK	0661-52	0669-00	0629-00		0626-00	0142-00
6RA5-1000-TSK	0661-00	0669-00	0629-00		0626-00	0142-00
6RA5-2000-TSK	0661-00	0669-00	0629-00		0626-00	0142-00
6RB2-1000-FSM	0661-52	0669-00	0629-00	0630-00	0626-00	0140-00
6RB2-1000-TSK	0661-52	0669-00	0629-00	0630-00	0626-00	0142-00
6RB2-2000-FSD	0661-52	0669-00	0629-00	0630-00	0626-00	0140-00
6RB2-2000-TSE	0661-52	0669-00	0629-00	0630-00	0626-00	0140-00
6RB2-2000-TSK	0661-52	0669-00	0629-00	0630-00	0626-00	0142-00
6RB5-2000-TSK	0661-52	0669-00	0629-00	0630-00	0626-00	0142-00
• 6RE2-2000-FSD	0661-66	0669-00	0629-00		0626-00	0140-00
• 6RE2-2000-TSE	0661-66	0669-00	0629-00		0626-00	0140-00
• 6RE2-2000-TSK	0661-66	0669-00	0629-00		0626-00	0142-00
• 6RE2-3000-FSD	0661-52	0669-00	0629-00		0626-00	0140-00
• 6RE2-3000-TSE	0661-52	0669-00	0629-00		0626-00	0140-00
• 6RE2-3000-TSK	0661-52	0669-00	0629-00		0626-00	0140-00
6RF5-2000-FSD	0661-00	0669-00	0629-00		0626-00	0140-00
6RF5-2000-TSE	0661-00	0669-00	0629-00		0626-00	0140-00
6RH1-2000-TSE	0661-51	0669-54	0629-00		0627-00	0140-00
6RH1-2000-TSK	0661-51	0669-54	0629-00		0627-00	0142-00
6RH1-3500-FSD	0661-51	0669-54	0629-00		0627-00	0140-01
6RH1-3500-TSE	0661-51	0669-54	0629-00		0627-00	0140-01
6RH1-3500-TSK	0661-51	0669-54	0629-00		0627-00	0142-01
6RH5-2000-TSK	0661-51	0669-54	0629-00		0627-00	0142-01
6RH5-3500-TSE	0661-51	0669-54	0629-00		0627-00	0140-01
6RJ1-3000-FSD	0661-60	0669-55	0629-00		0628-01	0140-00
6RJ1-4000-FSD	0661-60	0669-55	0629-00		0628-01	0140-01
6RJ1-4000-FSU	0661-60	0669-55	0629-00		0628-01	0140-01
6RJ1-4000-TSE	0661-60	0669-55	0629-00		0628-01	0140-01
6RJ1-4000-TSN	0661-60	0669-55	0629-00		0628-01	0142-01

- 1 Bank Unloading
- 2 Banks Unloading

6D, 6R and 6T – Semi-Hermetic Compressors

6R - Compressor Parts

Model	Valve Plate Kit	Complete Gasket Set	Cylinder Head Gasket	Unloader Cylinder Head Gasket	Valve Plate Gasket	Terminal Plate Group
	(998-)	(998-)	(020-)	(020-)	(020-)	(521-)
• 6RK2-2000-TSE	0661-51	0669-54	0629-00		0627-00	0140-00
• 6RK2-2000-TSK	0661-51	0669-54	0629-00		0627-00	0142-00
• 6RK2-3500-FSD	0661-51	0669-54	0629-00		0627-00	0140-01
• 6RK2-3500-TSE	0661-51	0669-54	0629-00		0627-00	0140-01
• 6RK2-3500-TSK	0661-51	0669-54	0629-00		0627-00	0142-01
• 6RK5-3500-FSD	0661-51	0669-54	0629-00		0627-00	0140-01
• 6RK5-3500-TSK	0661-51	0669-54	0629-00		0627-00	0142-01
6RL1-2500-FSM	0661-49	0669-54	0629-00		0627-00	0140-00
6RL1-2500-TSE	0661-49	0669-54	0629-00		0627-00	0140-00
6RL1-2500-TSK	0661-49	0669-54	0629-00		0627-00	0142-00
6RL5-2500-FSM	0661-49	0669-54	0629-00		0627-00	0140-00
6RL5-2500-TSE	0661-49	0669-54	0629-00		0627-00	0140-00
•• 6RN2-2000-FSD	0661-52	0669-00	0629-00		0626-00	0140-00
•• 6RN2-2000-TSE	0661-52	0669-00	0629-00		0626-00	0140-00
•• 6RN2-2000-TSK	0661-52	0669-00	0629-00		0626-00	0142-00
•• 6RN2-3000-FSD	0661-52	0669-00	0629-00		0626-00	0140-00
•• 6RN2-3000-TSE	0661-52	0669-00	0629-00		0626-00	0140-00
•• 6RN2-3000-TSK	0661-52	0669-00	0629-00		0626-00	0142-00
•• 6RN5-3000-TSK	0661-52	0669-00	0629-00		0626-00	0142-00
•• 6RP2-2000-TSE	0661-51	0669-54	0629-00		0627-00	0140-00
•• 6RP2-2000-TSK	0661-51	0669-54	0629-00		0627-00	0142-00
•• 6RP2-3500-FSD	0661-51	0669-54	0629-00		0627-00	0140-01
•• 6RP2-3500-TSE	0661-51	0669-54	0629-00		0627-00	0140-01
•• 6RP2-3500-TSK	0661-51	0669-54	0629-00		0627-00	0142-01
•• 6RP5-3500-TSK	0661-51	0669-54	0629-00		0627-00	0142-01
• 6RR2-4000-FSD	0661-60	0669-55	0629-00		0628-01	0140-01
• 6RR2-4000-FSU	0661-60	0669-55	0629-00		0628-01	0140-01
• 6RR2-4000-TSE	0661-60	0669-55	0629-00		0628-01	0140-01
• 6RR2-4000-TSN	0661-60	0669-55	0629-00		0628-01	0142-01
•• 6RS2-4000-FSD	0661-60	0669-55	0629-00		0628-01	0140-01
•• 6RS2-4000-FSU	0661-60	0669-55	0629-00		0628-01	0140-01
•• 6RS2-4000-TSE	0661-60	0669-55	0629-00		0628-01	0140-01
•• 6RS2-4000-TSN	0661-60	0669-55	0629-00		0628-01	0142-01
6RT1-3000-FSD	0661-57	0669-56	0629-00		0628-00	0140-00
6RT1-3000-TSE	0661-57	0669-56	0629-00		0628-00	0140-00
6RT1-3000-TSK	0661-57	0669-56	0629-00		0628-00	0142-00

- 1 Bank Unloading
- 2 Banks Unloading

Semi-Hermetic Compressors – 6D, 6R and 6T

6R Compressor Capacity Control Kits

Standard Model	Blocked Suction Capacity Control Model (33% Single Bank)	Blocked Suction Capacity Control Model (66% Two Bank)	Capacity Control Conversion Kit with 24V Unloader	Capacity Control Conversion Kit with 120V Unloader	Capacity Control Conversion Kit with 240V Unloader
6RA*-2000	6RE*-2000	6RN*-2000	998-0119-08	998-0119-09	998-0119-10
6RA*-3000	6RE*-3000	6RN*-3000	998-0119-08	998-0119-09	998-0119-10
6RH*-2000	6RK*-2000	6RP*-2000	998-0119-08	998-0119-09	998-0119-10
6RH*-3500	6RK*-3500	6RP*-3500	998-0119-08	998-0119-09	998-0119-10
6RJ*-3000	6RR*-3000	6RS*-3000	998-0119-16	998-0119-17	998-0119-18
6RJ*-4000	6RR*-4000	6RS*-4000	998-0119-16	998-0119-17	998-0119-18

Note : The position occupied by * can be the number 1, 2, 3, 4, 5 or 8

6T - Compressor Parts

Model	Valve Plate Kit	Complete Gasket Set	Cylinder Head Gasket	Valve Plate Gasket	Terminal Plate Group
	(998-)	(998-)	(020-)	(020-)	(521-)
6TM1-2000-TSE	0661-49	0669-54	0632-00	0627-00	0140-00
6TM1-2000-TSK	0661-49	0669-54	0632-00	0627-00	0142-00



6D Copeland Discus™ III – Semi-Hermetic Compressors

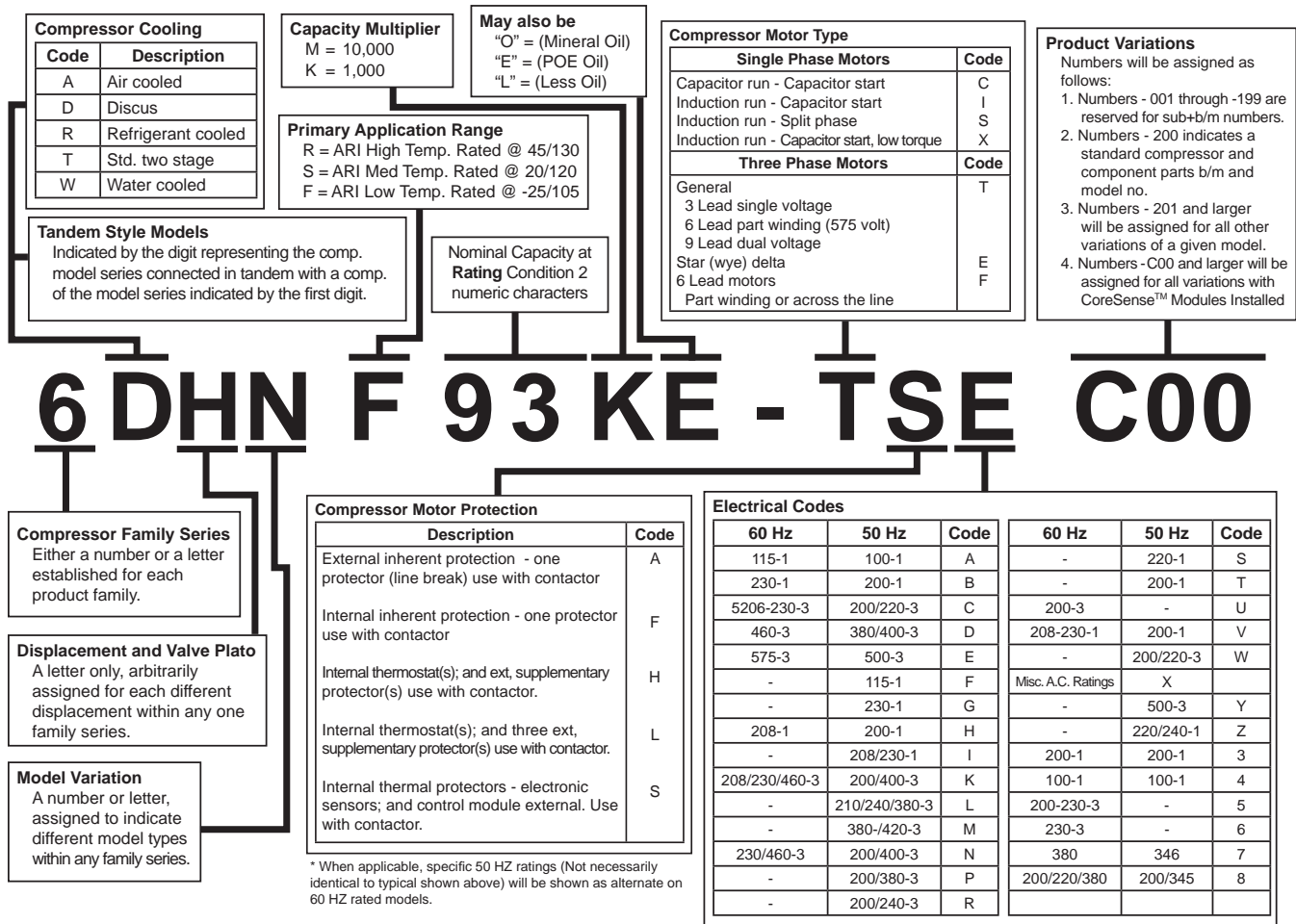

Cooling Fan Kits

Cooling Fan Kits	Part #	Used On
115 Volt Fan Motor Kit	998-0550-02	
115 Volt Replacement Fan Motor	050-0254-04	
230 Volt Fan Motor Kit	998-0550-00	
230 Volt Replacement Fan Motor	050-0254-02	All 6D Discus III
460 Volt Fan Motor Kit	998-0550-01	
460 Volt Replacement Fan Motor	050-0254-05	
Fan Mounting Kit	998-0574-18	
Fan Blade	083-0118-00	

Service Valves

Part #	Size	Discharge	Suction	Style	MTG Center	Thread
998-0510-46	1 3/8"	X		Rotalock		1 3/4"-12
998-0510-66	1 5/8"	X		Rotalock		1 3/4"-12
998-0510-11	1 3/8"		X	Bolt on (2)	2 1/4" x 2 1/4"	
998-0510-07	1 5/8"		X	Bolt on (4)	2 1/2" x 2 1/2"	
998-0510-20	2 1/8"		X	Bolt on (4)	3 1/16" x 3 1/16"	

Common Replacement Parts

Common Parts	Part Number
Sight Glass Kit	998-0002-02
Sight Glass O-Ring	020-0844-05
Oil Screen Kit	998-0513-02
Magnetic Plug Gasket - 1" Internal Thread	020-0006-52
Magnetic Plug Gasket - 1 1/8" Internal Thread	020-0006-38
Oil Pump Kit	998-0008-33
Suction Strainer Assembly	548-0116-00
Terminal Jumpers/Extensions	521-0065-00
Gaskets	Part Number
Complete Gasket Set	998-3669-01
Capacity Control Valve - 6D*N models	020-1465-00
Capacity Control Blank Plate (Full Load Gasket) 6D*N models	020-1445-00
Stator Cover	020-0755-00
Bottom Plate	020-1265-00
Oil Pump	020-1267-00
Housing Cover	020-1545-00
CoreSense™ Kits and Parts	Part Number
CoreSense Module	943-0128-00
6D CoreSense Wiring Harness	929-0098-00
CoreSense DLT Thermistor	985-0109-50
CoreSense Module Mounting Bracket/Stud Kit	974-1315-00
CoreSense Current Torroid	943-0064-00
Oil Sensor Kit	998-0162-01
Copper Gasket for Sensor	020-0297-13
O-Ring Gasket for Sensor	020-0003-28
Crankcase Heater	Part Number
120V 100 Watt (US part# 918-0028-00)	518-0028-06
240V 100 Watt (US part# 918-0028-01)	518-0028-07
Crankcase Heater Sleeve	030-0186-01
Digital Compressor Unloader Valve/Coil	Part Number
Valve Less Coil - 6D*X models	910-0127-00
24 Volt Coil Only	923-0084-00
120 Volt Coil Only	923-0084-01
240 Volt Coil Only	923-0084-02
IDCM Module	943-0194-00
Digital Unloader Gasket - 6D*X models	020-1446-00
Unloader Valves & Coils	Part Number
Valve Less Coil	998-0213-00
24 Volt Valve and Coil Kit	998-0213-01
24 Volt Coil Only	023-0091-00
120 Volt Valve and Coil Kit	998-0213-02
120 Volt Coil Only	023-0091-01
240 Volt Valve and Coil Kit	998-0213-03
240 Volt Coil Only	023-0091-02

6D Copeland Discus™ III – Semi-Hermetic Compressors

Copeland Discus™ III to Copeland Discus™ II cross reference matrix

Use this matrix to determine required accessory kits if you are replacing a field-failed Copeland Discus™ III compressor with a Copeland Discus™ II service model.

6D	Kit Number		Do I need this Kit? Check the Discus III nomenclature	Kit includes:	Special notes
	CoreSense Protection	CoreSense Diagnostics (ISD)			
Electronics Kit	974-1315-00	998-3000-06	6DKNF93KE-TSK-C00 C = Protection kit 6DKNF93KE-TSK-A00 A = Diagnostics kit	Mounting parts (studs and nuts) necessary to reinstall CoreSense Protection or Diagnostics on Discus II service models.	You will never need both of these kits, but you will always need one. (The exception is the -441 BOM. In this case, neither kit is required.)
Low Temp Kit	998-3000-16 (Demand Cooling™) 998-0574-13 (head fan)		6DKXF93KE-TSK-A00 You need it if this digit is F**	Head fan and Demand Cooling™ mounting kits (including studs and nuts)	Depending on the refrigerant in the system, you may not need to use the demand cooling mounting parts.
Unloading Kit	998-0212-00 (less coil)	998-0212-00 (less coil) 998-0212-01 (24V)	6DKXF93KE-TSK-A00 You need it if this digit is anything except H, J, B or G	Gasket and solenoid valve assembly	6D models receive two unloading kits. NOTE: It is possible unloading has been added to the compressor at the time of install. If this is the case, unloading kits will be required.
	998-0212-02 (115V coil) 998-0212-03 (208/220V coil)				
(2 kits will be sent *)					

* Digital compressors (6DKXF93KE-TSK-A00/this digit of the Discus™ III nomenclature is X) will only receive one kit. Digital applications run one unloader head and one digital head.

**Refer to OEM equipment guidelines. Demand Cooling is only used in R-22, R-407A, R-407C and R-407F applications.
NOTE: Any 6DJ, 6DR, or 6DS Discus™ III model being replaced with a Discus™ II must be a -899 BOM (ie: 6DE3F11ME-TSK-899). This model is a standard bottom plate in place of the deep sump bottom plate.



Semi-Hermetic Compressors – 6D Copeland Discus™ III

6D Discus™ III Delta Reed Models - Compressor Parts

Model	Equivalent Digital Model	Standard Valve Plate Kit	Unloader Valve Plate Kit	Digital Valve Plate Kit	Cylinder Head Gasket	Unloader Cylinder Head Gasket	Digital Cylinder Head Gasket	Valve Plate Gasket	Terminal Plate Group
		(998-)	(998-)	(998-)	(020-)	(020-)	(020-)	(020-)	(521-)
6DBNR32ME-FSD	N/A	3661-27			1505-00			1450-00	0140-01
6DBNR32ME-TSE	N/A	3661-27			1505-00			1450-00	0140-01
6DBNR32ME-TSK	6DBXR32ME-TSK	3661-27			1505-00			1450-00	0142-01
D 6DBXR32ME-TSK		3661-27		3661-66	1505-00		1455-00	1450-00	0142-01
6DGNR37ME-FSD	N/A	3661-27			1505-00			1450-02	0140-01
6DGNR37ME-FSU	N/A	3661-27			1505-00			1450-02	0140-01
6DGNR37ME-TSE	6DGXR37ME-TSE	3661-27			1505-00			1450-02	0140-01
6DGNR37ME-TSN	6DGXR37ME-TSN	3661-27			1505-00			1450-02	0142-01
D 6DGXR37ME-TSE		3661-27	3661-28	3661-66	1505-00		1455-00	1450-02	0140-01
D 6DGXR37ME-TSN		3661-27	3661-28	3661-66	1505-00		1455-00	1450-02	0142-01
6DHNF93KE-FSD	6DHXF93KE-FSD	3661-26			1505-00			1450-00	0140-00
6DHNF93KE-TSE	6DHXF93KE-TSE	3661-26			1505-00			1450-00	0140-00
6DHNF93KE-TSK	6DHXF93KE-TSK	3661-26			1505-00			1450-00	0142-00
D 6DHXF93KE-TSE		3661-26		3661-65	1505-00		1455-00	1450-00	0140-00
D 6DHXF93KE-TSK		3661-26		3661-65	1505-00		1455-00	1450-00	0142-00
6DHNR23ME-TSK	N/A	3661-26			1505-00			1450-00	0142-00
6DHNR35ME-FSD	N/A	3661-27			1505-00			1450-00	0140-01
6DHNR35ME-TSE	6DHXR35ME-TSE	3661-27			1505-00			1450-00	0140-01
6DHNR35ME-TSK	6DHXR35ME-TSK	3661-27			1505-00			1450-00	0142-01
D 6DHXR35ME-TSE		3661-27		3661-66	1505-00		1455-00	1450-00	0140-01
D 6DHXR35ME-TSK		3661-27		3661-66	1505-00		1455-00	1450-00	0142-01
6DJNF11ME-FSD	N/A	3661-26			1505-00			1450-03	0140-00
6DJNF11ME-TSE	6DJXF11ME-TSE	3661-26			1505-00			1450-03	0140-00
6DJNF11ME-TSK	6DJXF11ME-TSK	3661-26			1505-00			1450-03	0142-00
D 6DJXF11ME-TSE		3661-26		3661-65	1505-00		1455-00	1450-03	0140-00
D 6DJXF11ME-TSK		3661-26		3661-65	1505-00		1455-00	1450-03	0142-00
6DJNR28ME-TSE	N/A	3661-27			1505-00			1450-03	0140-00
6DJNR28ME-TSK	N/A	3661-27			1505-00			1450-03	0142-00
6DJNR40ME-FSD	N/A	3661-27			1505-00			1450-03	0140-01
6DJNR40ME-TSE	6DJXR40ME-TSE	3661-27			1505-00			1450-03	0140-01
6DJNR40ME-TSN	6DJXR40ME-TSN	3661-27			1505-00			1450-03	0142-01
D 6DJXR40ME-TSE		3661-27		3661-66	1505-00		1455-00	1450-03	0140-01
D 6DJXR40ME-TSN		3661-27		3661-66	1505-00		1455-00	1450-03	0142-01
• 6DKNF93KE-FSD	N/A	3661-26	3661-25		1505-00	1454-00		1450-00	0140-00
• 6DKNF93KE-TSE	6DHXF93KE-TSE	3661-26	3661-25		1505-00	1454-00		1450-00	0140-00
• 6DKNF93KE-TSK	6DHXF93KE-TSK	3661-26	3661-25		1505-00	1454-00		1450-00	0142-00
D 6DKXF93KE-TSE		3661-26	3661-25	3661-65	1505-00	1454-00	1455-00	1450-00	0140-00
D 6DKXF93KE-TSK		3661-26	3661-25	3661-65	1505-00	1454-00	1455-00	1450-00	0142-00

D Digital Model

• 1 Bank Unloading

•• 2 Banks Unloading

6D Copeland Discus™ III – Semi-Hermetic Compressors

6D Discus™ III Delta Reed Models - Compressor Parts

Model	Equivalent Digital Model	Standard Valve Plate Kit	Unloader Valve Plate Kit	Digital Valve Plate Kit	Cylinder Head Gasket	Unloader Cylinder Head Gasket	Digital Cylinder Head Gasket	Valve Plate Gasket	Terminal Plate Group
		(998-)	(998-)	(998-)	(020-)	(020-)	(020-)	(020-)	(521-)
D 6DHXR35ME-TSK		3661-27		3661-66	1505-00		1455-00	1450-00	0142-01
6DJNF11ME-FSD	N/A	3661-26			1505-00			1450-03	0140-00
6DJNF11ME-TSE	6DJXF11ME-TSE	3661-26			1505-00			1450-03	0140-00
6DJNF11ME-TSK	6DJXF11ME-TSK	3661-26			1505-00			1450-03	0142-00
D 6DJXF11ME-TSE		3661-26		3661-65	1505-00		1455-00	1450-03	0140-00
D 6DJXF11ME-TSK		3661-26		3661-65	1505-00		1455-00	1450-03	0142-00
6DJNR28ME-TSE	N/A	3661-27			1505-00			1450-03	0140-00
6DJNR28ME-TSK	N/A	3661-27			1505-00			1450-03	0142-00
6DJNR40ME-FSD	N/A	3661-27			1505-00			1450-03	0140-01
6DJNR40ME-TSE	6DJXR40ME-TSE	3661-27			1505-00			1450-03	0140-01
6DJNR40ME-TSN	6DJXR40ME-TSN	3661-27			1505-00			1450-03	0142-01
D 6DJXR40ME-TSE		3661-27		3661-66	1505-00		1455-00	1450-03	0140-01
D 6DJXR40ME-TSN		3661-27		3661-66	1505-00		1455-00	1450-03	0142-01
• 6DKNF93KE-FSD	N/A	3661-26	3661-25		1505-00	1454-00		1450-00	0140-00
• 6DKNF93KE-TSE	6DHXF93KE-TSE	3661-26	3661-25		1505-00	1454-00		1450-00	0140-00
• 6DKNF93KE-TSK	6DHXF93KE-TSK	3661-26	3661-25		1505-00	1454-00		1450-00	0142-00
D 6DKXF93KE-TSE		3661-26	3661-25	3661-65	1505-00	1454-00	1455-00	1450-00	0140-00
D 6DKXF93KE-TSK		3661-26	3661-25	3661-65	1505-00	1454-00	1455-00	1450-00	0142-00
• 6DKNR23ME-TSK	N/A	3661-27	3661-28		1505-00	1454-00		1450-00	0142-00
• 6DKNR35ME-FSD	N/A	3661-27	3661-28		1505-00	1454-00		1450-00	0140-01
• 6DKNR35ME-TSE	6DJXR35ME-TSE	3661-27	3661-28		1505-00	1454-00		1450-00	0140-01
• 6DKNR35ME-TSK	6DJXR35ME-TSK	3661-27	3661-28		1505-00	1454-00		1450-00	0142-01
D 6DKXR35ME-TSE		3661-27	3661-28	3661-66	1505-00	1454-00	1455-00	1450-00	0140-01
D 6DKXR35ME-TSK		3661-27	3661-28	3661-66	1505-00	1454-00	1455-00	1450-00	0142-01
• 6DMNR37ME-FSD	N/A	3661-27	3661-28		1505-00	1454-00		1450-02	0140-01
• 6DMNR37ME-FSU	N/A	3661-27	3661-28		1505-00	1454-00		1450-02	0140-01
• 6DMNR37ME-TSE	6DGXR37ME-TSE	3661-27	3661-28		1505-00	1454-00		1450-02	0140-01
• 6DMNR37ME-TSN	6DGXR37ME-TSN	3661-27	3661-28		1505-00	1454-00		1450-02	0142-01
D 6DMXR37ME-TSE		3661-27	3661-28	3661-66	1505-00		1455-00	1450-02	0140-01
D 6DMXR37ME-TSN		3661-27	3661-28	3661-66	1505-00		1455-00	1450-02	0142-01
•• 6DNNR37ME-FSD	N/A	3661-27	3661-28		1505-00	1454-00		1450-02	0140-01
•• 6DNNR37ME-FSU	N/A	3661-27	3661-28		1505-00	1454-00		1450-02	0140-01
•• 6DNNR37ME-TSE	6DMXR37ME-TSE	3661-27	3661-28		1505-00	1454-00		1450-02	0140-01
•• 6DNNR37ME-TSN	6DMXR37ME-TSN	3661-27	3661-28		1505-00	1454-00		1450-02	0142-01
•• 6DPNF93KE-FSD	N/A	3661-26	3661-25		1505-00	1454-00		1450-00	0140-00
•• 6DPNF93KE-TSE	6DKXF93KE-TSE	3661-26	3661-25		1505-00	1454-00		1450-00	0140-00
•• 6DPNF93KE-TSK	6DKXF93KE-TSK	3661-26	3661-25		1505-00	1454-00		1450-00	0142-00
•• 6DPNR23ME-TSE	N/A	3661-27	3661-28		1505-00	1454-00		1450-00	0140-00

D Digital Model

• 1 Bank Unloading

•• 2 Banks Unloading

Semi-Hermetic Compressors – 6D Copeland Discus™ III

6D Discus™ III Delta Reed Models - Compressor Parts

Model	Equivalent Digital Model	Standard Valve Plate Kit	Unloader Valve Plate Kit	Digital Valve Plate Kit	Cylinder Head Gasket	Unloader Cylinder Head Gasket	Digital Cylinder Head Gasket	Valve Plate Gasket	Terminal Plate Group
		(998-)	(998-)	(998-)	(020-)	(020-)	(020-)	(020-)	(521-)
•• 6DPNR23ME-TSK	N/A	3661-27	3661-28		1505-00	1454-00		1450-00	0142-00
•• 6DPNR35ME-FSD	N/A	3661-27	3661-28		1505-00	1454-00		1450-00	0140-01
•• 6DPNR35ME-TSE	6DKXR35ME-TSE	3661-27	3661-28		1505-00	1454-00		1450-00	0140-01
•• 6DPNR35ME-TSK	6DKXR35ME-TSK	3661-27	3661-28		1505-00	1454-00		1450-00	0142-01
• 6DRNF11ME-FSD	6DJXF11ME-FSD	3661-26	3661-25		1505-00	1454-00		1450-03	0140-00
• 6DRNF11ME-TSE	6DJXF11ME-TSE	3661-26	3661-25		1505-00	1454-00		1450-03	0140-00
• 6DRNF11ME-TSK	6DJXF11ME-TSK	3661-26	3661-25		1505-00	1454-00		1450-03	0142-00
D 6DRXF11ME-TSE		3661-26	3661-25	3661-65	1505-00	1454-00	1455-00	1450-03	0140-00
D 6DRXF11ME-TSK		3661-26	3661-25	3661-65	1505-00	1454-00	1455-00	1450-03	0142-00
• 6DRNR28ME-TSK	N/A	3661-27	3661-28		1505-00	1454-00		1450-03	0142-00
• 6DRNR40ME-FSD	N/A	3661-27	3661-28		1505-00	1454-00		1450-03	0140-01
• 6DRNR40ME-FSU	N/A	3661-27	3661-28		1505-00	1454-00		1450-03	0140-01
• 6DRNR40ME-TSE	6DJXR40ME-TSE	3661-27	3661-28		1505-00	1454-00		1450-03	0140-01
• 6DRNR40ME-TSN	6DJXR40ME-TSN	3661-27	3661-28		1505-00	1454-00		1450-03	0142-01
D 6DRXR40ME-TSE		3661-27	3661-28	3661-66	1505-00	1454-00	1455-00	1450-03	0140-01
D 6DRXR40ME-TSN		3661-27	3661-28	3661-66	1505-00	1454-00	1455-00	1450-03	0142-01
•• 6DSNF11ME-FSD	N/A	3661-26	3661-25		1505-00	1454-00		1450-03	0140-00
•• 6DSNF11ME-TSE	6DRXR40ME-TSE	3661-26	3661-25		1505-00	1454-00		1450-03	0140-00
•• 6DSNF11ME-TSK	6DRXR40ME-TSN	3661-26	3661-25		1505-00	1454-00		1450-03	0142-00
•• 6DSNR28ME-TSE	N/A	3661-27	3661-28		1505-00	1454-00		1450-03	0140-00
•• 6DSNR28ME-TSK	N/A	3661-27	3661-28		1505-00	1454-00		1450-03	0142-00
•• 6DSNR40ME-FSD	N/A	3661-27	3661-28		1505-00	1454-00		1450-03	0140-01
•• 6DSNR40ME-FSU	N/A	3661-27	3661-28		1505-00	1454-00		1450-03	0140-01
•• 6DSNR40ME-TSE	6DRXR40ME-TSE	3661-27	3661-28		1505-00	1454-00		1450-03	0140-01
•• 6DSNR40ME-TSN	6DRXR40ME-TSN	3661-27	3661-28		1505-00	1454-00		1450-03	0142-01
6DUNF13ME-AWD	6DUXF13ME-AWD	3661-30			1505-00	1454-00		1450-04	0140-01
6DUNR49ME-AWD	6DUXR49ME-AWD	3661-31			1505-00	1454-00		1450-04	0140-01
D 6DUXF13ME-AWD		3661-30		3661-67	1505-00	1454-00	1455-00	1450-04	0140-01
D 6DUXR49ME-AWD		3661-31		3661-68	1505-00	1454-00	1455-00	1450-04	0140-01
6DVNF13ME-AWD	6DVXF13ME-AWD	3661-30	3661-29		1505-00	1454-00		1450-04	0140-01
6DVNR49ME-AWD	6DVXR49ME-AWD	3661-31	3661-32		1505-00	1454-00		1450-04	0140-01
D 6DVXF13ME-AWD		3661-30	3661-29	3661-67	1505-00	1454-00	1455-00	1450-04	0140-01
D 6DVXR49ME-AWD		3661-31	3661-32	3661-68	1505-00	1454-00	1455-00	1450-04	0140-01
6DWRN32ME-FSD	N/A	3661-27	3661-28		1505-00	1454-00		1450-00	0140-01
6DWRN32ME-TSE	6DBXR32ME-TSE	3661-27	3661-28		1505-00	1454-00		1450-00	0140-01
6DWRN32ME-TSK	6DBXR32ME-TSK	3661-27	3661-28		1505-00	1454-00		1450-00	0142-01
6DYNR32ME-FSD	N/A	3661-27	3661-28		1505-00	1454-00		1450-00	0140-01
6DYNR32ME-TSE	6DWXR32ME-TSE	3661-27	3661-28		1505-00	1454-00		1450-00	0140-01
6DYNR32ME-TSK	6DWXR32ME-TSK	3661-27	3661-28		1505-00	1454-00		1450-00	0142-01

D Digital Model

• 1 Bank Unloading

•• 2 Banks Unloading

6D Copeland Discus™ III – Semi-Hermetic Compressors

6D Discus™ III Compressor Capacity Control Kits

Standard Model	Blocked Suction Capacity Control Model (33% Single Bank)	Blocked Suction Capacity Control Model (66% Two Bank)	Capacity Control Conversion Kit with 24V Unloader	Capacity Control Conversion Kit with 120V Unloader	Capacity Control Conversion Kit with 240V Unloader
6DBNR32ME	6DWRNR32ME	6DYNR32ME	998-3119-22	998-3119-23	998-3119-24
6DGNR37ME	6DMNR37ME	6DNNR37ME	998-3119-22	998-3119-23	998-3119-24
6DHNF93KE	6DKNF93KE	6DPNF93KE	998-3119-27	998-3119-28	998-3119-29
6DHNR23ME	6DKNR23ME	6DPNR23ME	998-3119-22	998-3119-23	998-3119-24
6DHNR35ME	6DKNR35ME	6DPNR35ME	998-3119-22	998-3119-23	998-3119-24
6DJNF11ME	6DRNF11ME	6DSNF11ME	998-3119-27	998-3119-28	998-3119-29
6DJNR28ME	6DRNR28ME	6DSNR28ME	998-3119-22	998-3119-23	998-3119-24
6DJNR40ME	6DRNR40ME	6DSNR40ME	998-3119-22	998-3119-23	998-3119-24

Contact Technical Services for any 6D Digital Capacity Modulation Applications.



Semi-Hermetic Compressors – 9R

Compressor Cooling	
Code	Description
A	Air cooled
D	Discus
R	Refrigerant cooled
T	Std. two stage
W	Water cooled

Tandem Style Models
Indicated by the digit representing the comp. model series connected in tandem with a comp. of the model series indicated by the first digit.

Comp. Motor Rating Nominal					
HP	Code	HP	Code	HP	Code
1/4	0025	2-3/4	0275	15	1500
1/3	0033	3 (0310)	0300	20	2000
1/2	0050	3-1/2	0350	25	2500
3/4	0075	4 (0406)	0400	30	3000
1	0100	5 (0506)	0500	35	3500
1-1/4	0125	6	0600	40	4000
1-1/2	0150	7-1/2 (0766)	0750	50	5000
1-3/4	0175	9	0900	60	6000
2	0200	10 (1015)	1000		
2-1/2	0250	12	1200		

Note: Nominal horsepower rating of tandem compressors is sum of individual compressor ratings

Compressor Motor Type	
Single Phase Motors	Code
Capacitor run - Capacitor start	C
Induction run - Capacitor start	I
Induction run - Split phase	S
Induction run - Capacitor start, low torque	X
Three Phase Motors	Code
General	T
3 Lead single voltage	
6 Lead part winding (575 volt)	
9 Lead dual voltage	
Star (wye) delta	E
6 Lead motors	F
Part winding or across the line	

Product Variations
Numbers will be assigned as follows:
1. Numbers -001 through -199 are reserved for sub+b/m numbers.
2. Numbers -200 indicates a standard compressor and component parts b/m and model no.
3. Numbers -201 and larger will be assigned for all other variations of a given model.

9RP2 - 1015 - TFE 800

Compressor Family Series
Either a number or a letter established for each product family.

Displacement and Valve Plate
A letter only, arbitrarily assigned for each different displacement within any one family series.

Model Variation
A number or letter, assigned to indicate different model types within any family series.

May also be
"A" = (Alkylbenzene)
"E" = (POE Oil)
"L" = (Less Oil)

Compressor Motor Protection	
Description	Code
External inherent protection - one protector (line break) use with contactor	A
Internal inherent protection - one protector use with contactor	F
Internal thermostat(s); and ext, supplementary protector(s) use with contactor.	H
Internal thermostat(s); and three ext, supplementary protector(s) use with contactor.	L
Internal thermal protectors - electronic sensors; and control module external. Use with contactor.	S

* When applicable, specific 50 Hz ratings (Not necessarily identical to typical shown above) will be shown as alternate on 60 HZ rated models.

Electrical Codes					
60 Hz	50 Hz	Code	60 Hz	50 Hz	Code
115-1	100-1	A	-	220-1	S
230-1	200-1	B	-	200-1	T
5206-230-3	200/220-3	C	200-3	-	U
460-3	380/400-3	D	208-230-1	200-1	V
575-3	500-3	E	-	200/220-3	W
-	115-1	F	Misc. A.C. Ratings	X	
-	230-1	G	-	500-3	Y
208-1	200-1	H	-	220/240-1	Z
-	208/230-1	I	200-1	200-1	3
208/230/460-3	200/400-3	K	100-1	100-1	4
-	210/240/380-3	L	200-230-3	-	5
-	380-/420-3	M	230-3	-	6
230/460-3	200/400-3	N	380	346	7
-	200/380-3	P	200/220/380	200/345	8
-	200/240-3	R			



9R – Semi-Hermetic Compressors

Common Replacement Parts

Common Parts	Part Number
Sight Glass Kit	998-0002-02
Sight Glass O-Ring	020-0844-04
Oil Screen Kit	998-0513-03
Oil Pump Kit	998-0008-33
Rotalock Adaptor Kit	998-0036-00
Terminal Plate Parts	Part Number
Terminal Fused Cluster (Fusite)	521-0018-00
Terminal Fused Seal (Fusite)	020-0844-02
“T” Block - used with Fusite electrical connector	921-0227-00
Terminal Insulator - models with terminal stud electrical connections	080-0026-00
Gaskets	Part Number
Complete Gasket Set	998-0669-37
Cylinder Head Gasket - all except 9RP and 9RT	020-0610-00
Cylinder Head Gasket - 9RP2	020-0607-00
Cylinder Head Gasket - 9RT	020-0608-00
Housing Cover	020-0749-00
Stator Cover	020-0130-00
Bottom Plate	020-0479-00
Oil Pump	020-1204-00
Terminal Plate	020-0146-00
Rotalock Adaptor	020-0012-09
Crankcase Heater	Part Number
120 Volt 100 Watt	518-0028-06
240 Volt 100 Watt	518-0028-07
Crankcase Heater Well	030-0187-01
9T (Two Stage) Compressor Parts	Part Number
Subcooler - replaces all previous part#'s	567-0014-00
Desuperheating/Subcooler TXV - all 9TK1/9TK2	510-0144-00
Desuperheating/Subcooler TXV - all 9TL1/9TL2/9TH1/9TH2	510-0144-02
Sentronic 3 Kits and Parts	Part Number
Complete Kit	585-1076-02
Sensor and Cable Kit	998-0162-00
Sensor Only	998-0162-01
Copper Gasket for Sensor	020-0297-13
O-Ring Gasket for Sensor	020-0003-28
Cooling Fan Kits for 9R Compressors	Part Number
120V w/Bottom Fan Guard	998-0550-05
120V w/Complete Fan Guard	998-0550-02
240V w/Bottom Fan Guard	998-0550-03
240V w/Complete Fan Guard	998-0550-00
460V w/Bottom Fan Guard	998-0550-04
460V w/Complete Fan Guard	998-0550-01
Fan Mounting Kit - "new" style 9R -0505/0765/1015/1505	998-0574-08
Fan Mounting Kit - "old" style (short cyl.head) 9R -0500/0760/1010/1500	998-0574-06
Fan Blade	083-0118-00
Top Fan Guard	024-0200-00

Semi-Hermetic Compressors – 9R

9R - Compressor Parts

Model	Valve Plate Kit	Valve Plate Gasket	Start Capacitor		Run Capacitor		Relay		Motor Protector Kit	Protector	Terminal Board Assy.
			OEM	Service	OEM	Service	OEM	Service			
	(998-)	(020-)	(014-)	(914-)	(014-)	(914-)	(040-)	(940-)			
9RA1-0505-CFB	0661-08	0128-01	0006-14	0006-09	0064-18	0037-22	0166-23	0001-64	998-0087-04	0144-00	0018-00
9RA1-0505-TFC	0661-08	0128-01							998-0086-09	0144-00	0018-00
9RA1-0505-TFD	0661-08	0128-01							998-0086-17	0144-00	0018-00
9RA1-0505-TFE	0661-08	0128-01							998-0086-29	0144-00	0018-00
9RA1-0506-CFB	0661-08	0128-01	0006-14	0006-09	0064-18	0037-22	0166-23	0001-64	998-0476-01	0144-00	0018-00
9RB1-0505-CFB	0661-09	0128-00							998-0087-04	0144-00	0018-00
9RB1-0505-TFC	0661-09	0128-00							998-0086-09	0144-00	0018-00
9RB1-0505-TFD	0661-09	0128-00							998-0086-17	0144-00	0018-00
9RB1-0505-TFE	0661-09	0128-00							998-0086-29	0144-00	0018-00
9RB1-0765-TFC	0661-09	0128-00							998-0086-22	0144-00	0018-00
9RB1-0765-TFD	0661-09	0128-00							998-0086-20	0144-00	0018-00
9RB1-0765-TFE	0661-09	0128-00							998-0086-40	0144-00	0018-00
9RC1-0765-TFC	0661-08	0128-00							998-0086-22	0144-00	0018-00
9RC1-0765-TFD	0661-08	0128-00							998-0086-20	0144-00	0018-00
9RC1-0765-TFE	0661-08	0128-00							998-0086-40	0144-00	0018-00
9RC1-1015-TFC	0661-08	0128-00							971-0504-06	0201-00	
9RC1-1015-TFD	0661-08	0128-00							998-0429-17	0201-00	
9RC1-1015-TFE	0661-08	0128-00							998-0429-11	0201-00	
9RJ1-0505-CFB	0661-09	0128-01	0006-14	0006-09	0064-16	0037-20	0166-23	0001-64	998-0087-04	0144-00	0018-00
9RJ1-0505-TFC	0661-09	0128-01							998-0086-09	0144-00	0018-00
9RJ1-0505-TFD	0661-09	0128-01							998-0086-17	0144-00	0018-00
9RJ1-0505-TFE	0661-09	0128-01							998-0086-29	0144-00	0018-00
9RJ1-0765-TFC	0661-09	0128-01							998-0086-21	0144-00	0018-00
9RJ1-0765-TFD	0661-09	0128-01							998-0086-20	0144-00	0018-00
9RJ1-0765-TFE	0661-09	0128-01							998-0086-40	0144-00	0018-00
9RP2-0765-TFC	0661-08	0128-00							998-0086-22	0144-00	0018-00
9RP2-0765-TFD	0661-08	0128-00							998-0086-20	0144-00	0018-00
9RP2-0765-TFE	0661-08	0128-00							998-0086-40	0144-00	0018-00
9RP2-1015-TFC	0661-08	0128-00							971-0504-06	0201-00	
9RP2-1015-TFD	0661-08	0128-00							998-0429-17	0201-00	
9RP2-1015-TFE	0661-08	0128-00							998-0429-11	0201-00	
9RS1-1505-TFD	0661-41	0320-00							998-0455-00	0201-00	
9RS1-1505-TFE	0661-41	0320-00							998-0455-02	0201-00	
9RS1-1505-TSC	0661-41	0320-00							998-0524-11	0145-00	
9RS2-0765-TFC	0661-08	0128-04							998-0086-23	0144-00	0018-00
9RS2-0765-TFD	0661-08	0128-04							998-0086-20	0144-00	0018-00
9RS2-0765-TFE	0661-08	0128-04							998-0086-26	0144-00	0018-00
9RS3-0765-TFC	0661-08	0128-04							998-0086-23	0144-00	0018-00
9RS3-0765-TFD	0661-08	0128-04							998-0086-20	0144-00	0018-00
9RS3-0765-TFE	0661-08	0128-04							998-0086-26	0144-00	0018-00
9RS3-1015-TFC	0661-08	0128-04							971-0504-06	0201-00	
9RS3-1015-TFD	0661-08	0128-04							998-0429-17	0201-00	
9RS3-1015-TFE	0661-08	0128-04							998-0429-11	0201-00	
9RT1-1505-TFD	0661-45	0320-00							998-0455-00	0201-00	
9RT1-1505-TFE	0661-45	0320-00							998-0455-02	0201-00	
9RT1-1505-TSC	0661-45	0320-00							998-0524-11	0145-00	

9T– Semi-Hermetic Compressors

9T - Compressor Parts

Model	Valve Plate Kit	Valve Plate Gasket	Start Capacitor		Run Capacitor		Relay		Motor Protector Kit	Protector	Terminal Board Assy.
	(998-)	(020-)	OEM	Service	OEM	Service	OEM	Service			
	(014-)	(914-)	(014-)	(914-)	(040-)	(940-)					
9TK1-0505-TFC	0661-36	0128-01							998-0086-38	0144-00	0018-00
9TK1-0505-TFD	0661-36	0128-01							998-0086-17	0144-00	0018-00
9TK1-0505-TFE	0661-36	0128-01							998-0086-29	0144-00	0018-00
9TK2-050E-TFC	0661-36	0128-01							998-0086-38	0144-00	0018-00
9TK2-050E-TFD	0661-36	0128-01							071-0429-31	0144-00	0018-00
9TL1-0765-TFC	0661-36	0128-00							998-0086-22	0144-00	0018-00
9TL1-0765-TFD	0661-36	0128-00							998-0086-20	0144-00	0018-00
9TL1-0765-TFE	0661-36	0128-00							998-0086-40	0144-00	0018-00
9TL2-076E-TFC	0661-36	0128-00							998-0086-22	0144-00	0018-00
9TL2-076E-TFD	0661-36	0128-00							998-0086-20	0144-00	0018-00
9TH1-1015-TFC	0661-36	0128-04							971-0504-06	0201-00	
9TH1-1015-TFD	0661-36	0128-04							998-0429-17	0201-00	
9TH2-101E-TFC	0661-36	0128-04							971-0504-06	0201-00	
9TH2-101E-TFD	0661-36	0128-04							998-0429-17	0201-00	

Note: All 9RC*/9RP*/9RS*-1015 models with a THC/THD/THE or TLC/TLD/TLE motor code use the same mechanical components listed above.

Note: All 9RS*/9RT*-1505 models with a THC/THD/THE or TLC/TLD/TLE motor code use the same mechanical components listed above. Motor protectors for the THC/THD/THE/TLC/TLD/TLE models are no longer available (NLA)

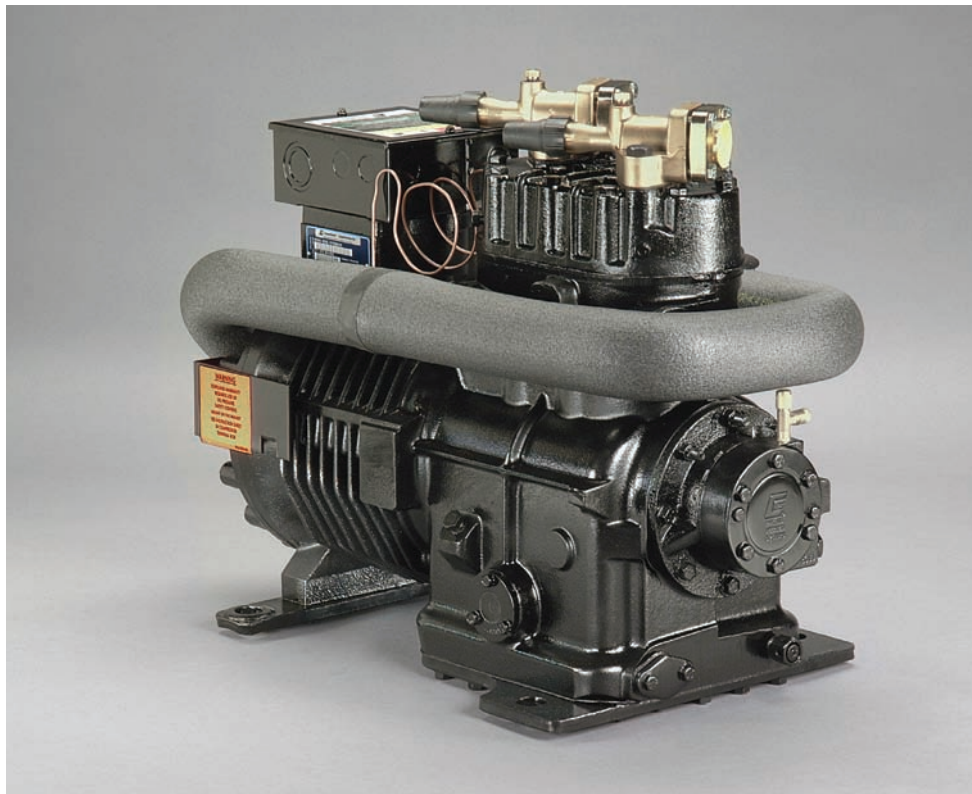

Application Range		
Code	Application	Refrn/Substance Compressed
B	Ref MT / HT	R-22/R-404A, 410A/407A/407C/407F

Compressor Motor Types		
Phase	Description	Code
1	Capacitor Run - Permanent Split Capacitor	P
3	General - 3 Lead Single Voltage - 6 Lead Part Winding (575 Volt)	T

Compressor Motor Protection	
Type Protection	Code
Internal Inherent Protection	F
External Electronic Protection	W
External Enhanced	E

Family Series
Z = Scroll

Optional
E = POE Oil - AK/DA, 3MA or SP32

ZBD 15KCE - PFV - 230

Modulation	
Code	Description
D	Digital
DU	Digital Uneven Tandem
DT	Digital Even Tandem
S	Ultra Tech
T	Even Tandem
U	Uneven Tandem

Capacity Multiplier
M = 10,000
K = 1,000

Nominal Capacity at Rating Condition
2 - 3 numeric characters

Model Variation	
1	R
2	H
3	L
4	M
5	Q
6	S
A	W
B	V
C	T
D	

Voltage Electrical Codes			
Voltage Code	60 Hertz		50 Hertz
	B	230-1	
C	208-230-3	200-3	
D	460-3	380-240-3	
E	575-3		
J	265-1	220-240-1	
M		380-420-3	
P		380-3	
Q	265-1		
R		220-240-3	
S		220-1	
V	208-230-1	200-1*	
W		200-220-3	

Misc AC Voltages		
Z		220-240-1
5	200-230-3	200-220-3
7	380-3	
0		415-3
3	220-1	220-1

Bill of Material Product Variation



ZB – Copeland Scroll™ Compressors

Common Replacement Parts

Oil Controls and Adapters	Part Number
OMB Oil Control - All Models	065365
OMB Adapters	Sight Glass Connection-Part#
ZB15KCE-ZB48KCE, ZB57KCE	Int. Thread (3/4" NPTF)-065668
ZB56/75/92KCE, ZB11MCE	Int. Thread (3/4" NPTF)-065668
ZB56/75/92KCE, ZB11MCE	Ext. Thread (1 3/4"-12 UNF)-066078
ZB15KCE-ZB48KCE, ZB57KCE	Ext. Thread (1 1/4"-12 UNF)-066650
ZB50KCE, ZB58KCE-ZB114KCE	Ext. Thread (1 1/4"-12 UNF)-066077
All ZBK5E models	Ext. Thread (1 1/4"-12 UNF)-066077

CoreSense™ Parts	Part Number
ZB58K5E-ZB114K5E and ZF34K5E-ZF49K5E models	
CoreSense Module Kit	943-0151-00
CoreSense Current Module Kit	943-0159-00
Top Cap Thermistor Kit	998-0229-00

Discharge Line Thermostat	Part Number
1/2" Discharge Line Thermostat	998-7022-02
5/8" Discharge Line Thermostat	998-7022-04
3/4" Discharge Line Thermostat	998-7022-07
7/8" Discharge Line Thermostat	998-7022-05

Miscellaneous Parts	Part Number
Oil Sight Glass Kit - All models with sight glass	998-0010-00
Oil Adjustment (fill drain) Valve	910-0715-00
Terminal Block (T-block) Kit - includes terminal screws	921-0227-00
Molded Plug (for ZSKAE models)	529-0060-04



Motor Protector Modules

Note #	OEM	Service	Voltage
2A	071-0660-00	971-0641-00	120/240V
2A	071-0660-01	971-0641-01	24V
2B	071-0650-00	971-0547-01	120/240V

CoreSense Communication Motor Protector

Note #	OEM	Service	Voltage
3	571-0064-06	971-0064-05	120/240V
3	571-0065-05	971-0065-04	24V

Crankcase Heater Notes

Note #	OEM	Service	Volts	Watts	Lead Length
4	018-0091-21	918-0047-00	120V	90 WATT	48" LEAD
	018-0091-22	918-0047-01	240V		
	018-0091-23	918-0047-02	480V		
	018-0091-24	918-0047-03	575V		
		998-7029-00		CONDUIT BOX	
6	018-0094-00	918-0052-00	240V	40 WATT	21" LEAD
	018-0094-01	918-0052-01	120V		
7	018-0095-00		240V	70 WATT	29" LEAD
	018-0095-01		480V		
	018-0095-02		575V		
	018-0095-04	918-0043-00	240V		48" LEAD
	018-0095-05	918-0043-01	480V		
	018-0095-06	918-0043-02	575V		
	018-0095-07	918-0043-07	120V		
9	018-0091-17	918-0019-01	120V	70 WATT	30" LEAD
	018-0091-18	918-0019-04	240V		
	018-0091-19	918-0019-08	460V		
	018-0091-15	918-0019-09	575V		



ZB - Compressor Parts

Model	Start Capacitor		Run Capacitor		Relay		Motor Protector	Mounting Parts	Hard Mounting Parts	Crankcase Heater
	OEM	Service	OEM	Service	OEM	Service				
	(014-)	(914-)	(014-)	(914-)	(040-)	(940-)				
ZB10KCE-PFV*	0061-27	0036-03	0064-06	0037-10	0166-37	0001-79	IP	N/A	0116-00	6
ZB11KC(E)-PFV*	0061-27	0036-03	0064-07	0037-11	0166-37	0001-79	IP	N/A	0116-00	6
ZB13KCE-PFV*	0061-27	0036-03	0064-07	0037-11	0166-37	0001-79	IP	N/A	0116-00	6
ZB14KCE-PFV*	0061-27	0036-03	0064-07	0037-11	0166-37	0001-79	IP	N/A	0116-00	6
ZB15KA-PFV*	0061-27	0036-03	0064-08	0037-12	0166-37	0001-79	IP	N/A	0116-00	7
ZB15KA-TF*							IP	N/A	0116-00	7
ZB15KC(E)-PFV*	0061-27	0036-03	0064-08	0037-12	0166-37	0001-79	IP	998-0178-00	0116-00	7
ZB15KC(E)-TF*							IP	998-0178-00	0116-00	7
ZB19KA-PFV*	0061-27	0036-03	0064-25	0037-36	0166-37	0001-79	IP	N/A	0116-00	7
ZB19KA-TF*							IP	N/A	0116-00	7
ZB19KC(E)-PFV*	0061-27	0036-03	0064-25	0037-36	0166-37	0001-79	IP	N/A	0116-00	7
ZB19KC(E)-TF*							IP	N/A	0116-00	7
ZB21KA-PFV*	0061-27	0036-03	0064-25	0037-36	0166-37	0001-79	IP	N/A	0116-00	7
ZB21KA-TF*							IP	998-0178-00	0116-00	7
ZB21KC(E)-PFV*	0061-27	0036-03	0064-29	0037-40	0166-37	0001-79	IP	998-0178-00	0116-00	7
ZB21KC(E)-TF*							IP	998-0178-00	0116-00	7
D ZBD21KCE-PFV*	0061-27	0036-03	0064-29	0037-40	166.37	0001-79	IP	998-0178-00	0116-00	7
D ZBD21KCE-TF*							IP	998-0178-00	0116-00	7
ZB26KA-PFV*	0061-27	0036-03	0064-25	0037-36	0166-37	0001-79	IP	N/A	0116-00	7
ZB26KA-TF*							IP	998-0178-00	0116-00	7
ZB26KC(E)-PFV*	0061-27	0036-03	0064-29	0037-40	0166-37	0001-79	IP	N/A	0116-00	7
ZB26KC(E)-TF*							IP	998-0178-00	0116-00	7
D ZBD28KCB-TF*							IP	527-0158-00	0116-00	7
ZB29KCE-PFV*	0061-27	0036-03	0064-18	0037-22	0166-37	0001-79	IP	998-0178-00	0116-00	7
ZB29KCE-TF*							IP	998-0178-00	0116-00	7
D ZBD29KCE-TF5							IP	0178-00	0116-00	7
ZB30KA-PFV*	0006-15	0006-10	0064-26	0037-37	0166-37	0001-79	IP	N/A	0116-00	7
ZB30KA-TF*							IP	N/A	0116-00	7
ZB30KC(E)-PFV*	0006-15	0006-10	0064-26	0037-37	0166-37	0001-79	IP	N/A	0116-00	7
ZB30KC(E)-TF*							IP	N/A	0116-00	7
D ZBD30KCE-TF*							IP	0158-00	0116-00	7
ZB38KA-PFV*	0006-15	0006-10	0064-27	0037-38	0166-37	0001-79	IP	998-0178-00	0116-00	7
ZB38KA-TF*							IP	998-0178-00	0116-00	7
ZB38KC(E)-PFV*	0006-15	0006-10	0064-27	0037-38	0166-37	0001-79	IP	998-0178-00	0116-00	7
ZB38KC(E)-TF*							IP	998-0178-00	0116-00	7
ZB38KCP-TF*							IP	998-0178-00	0116-00	7
D ZBD38KCE-PFV							IP	527-0158-00	0116-00	7
D ZBD38KCE-TF*							IP	527-0158-00	0116-00	7
D ZBD38KCP-TF*							IP	527-0158-00	0116-00	7
ZB42KA-PFV*	0006-15	0006-10	0064-26	0037-37	0166-37	0001-79	IP	N/A	0116-00	7
ZB42KC(E)-PFV*	0006-15	0006-10	0064-16	0037-20	0166-28	0001-69	IP	N/A	0116-00	7
ZB45KA-TF*							IP	N/A	0116-00	7
ZB45KC(E)-TF*							IP	N/A	0116-00	7
D ZBD45KCE-TF*							IP	527-0158-00	0116-00	7
ZB48KCE-TF*							IP	527-0158-00	0116-00	7
ZB49KCP-TF*							IP	N/A	0116-00	7
ZB50KC(E)-TF*							IP	N/A	0116-00	4
ZB56KA-TW*							NOTE 2B	N/A	0116-00	9
ZB56KC(E)-TW*							NOTE 2B	N/A	0116-00	9
ZB57KC(E)-TF*							IP	N/A	0116-00	7
D ZBD57KCE-TF*							IP	527-0158-00	0116-00	7
ZB58K5E-TF*							IP	998-0178-00	0116-00	4
ZB58KC(E)-TF*							IP	998-0178-00	0116-00	4
D ZBD58KCE-TF*							IP	N/A	0116-00	4

D = Digital

ZB – Copeland Scroll™ Compressors

ZB - Compressor Parts

Model	Start Capacitor		Run Capacitor		Relay		Motor Protector	Mounting Parts	Hard Mounting Parts	Crankcase Heater
	OEM (014-)	Service (914-)	OEM (014-)	Service (914-)	OEM (040-)	Service (940-)				
ZB66K5E-TF*							IP	998-0178-00	0116-00	4
ZB66KC(E)-TF*							IP	998-0178-00	0116-00	4
ZB68KA-TW*							NOTE 2B	527-0158-00	0159-00	9
ZB69KCP-TF*							NOTE 2B	N/A	0116-00	4
D ZBD69KCP-TF*							IP	N/A	0116-00	4
ZB75KA-TW*							NOTE 2B	527-0158-00	0159-00	9
ZB75KC(E)-TW*							NOTE 2B	527-0158-00	0159-00	9
ZB76K5E-TF*							IP	998-0178-00	0116-00	4
ZB76KC(E)-TF*							IP	998-0178-00	0116-00	4
D ZBD76KCE-TF							IP	N/A	0116-00	4
ZB78KCP-TF*							IP	N/A	0116-00	4
D ZBD78KCP-TF*							IP	N/A	0116-00	4
ZB88KC(E)-TF*							IP	N/A	0116-00	4
ZB92KA-TW*							NOTE 2B	N/A	0159-00	9
ZB92KC(E)-TW*							NOTE 2B	N/A	0159-00	9
ZB95K5E-TF*							IP	998-0178-00	0210-00	4
ZB95K5E-TW*							NOTE 2A	998-0178-00	0210-00	4
ZB95KC(E)-TE*							NOTE 3	998-0178-00	0210-00	4
ZB95KC(E)-TW*							NOTE 2A	998-0178-00	0210-00	4
ZB107KCP-TE*							NOTE 3	998-0178-00	0210-00	4
ZB107KCP-TW*							NOTE 2B	N/A	0116-00	4
ZB11MA-TW*							NOTE 2B	N/A	0159-00	9
ZB11MC(E)-TW*							NOTE 2B	N/A	0159-00	9
ZB114K5E-TF*							IP	527-0158-00	0210-00	4
ZB114K5E-TW*							NOTE 2A	527-0158-00	0210-00	4
ZB114KC(E)-TE*							NOTE 3	527-0158-00	0210-00	4
ZB114KC(E)-TW*							NOTE 2A	N/A	0210-00	4
ZB135KCP-TE*							NOTE 3	N/A	0178-00	4
ZB172KCP-TE*							NOTE 3	N/A	0175-02	4

D = Digital

Advanced Scroll Temperature Protection (ASTP), a feature to guard scroll compressors from overheating.

ASTP MODELS		
ZB50	-	ZR84
ZB58	ZP90	ZR94
ZB66	ZP103	ZR108
ZB76	ZP120	ZR125
ZB88	ZP137	ZR144
ZB95	ZP154	ZR160
ZB114	ZP182	ZR190

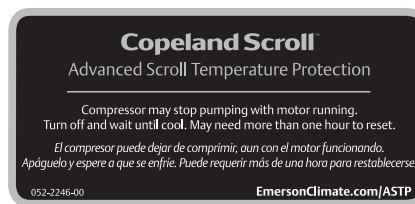

Copeland Scroll™ Compressors – ZF

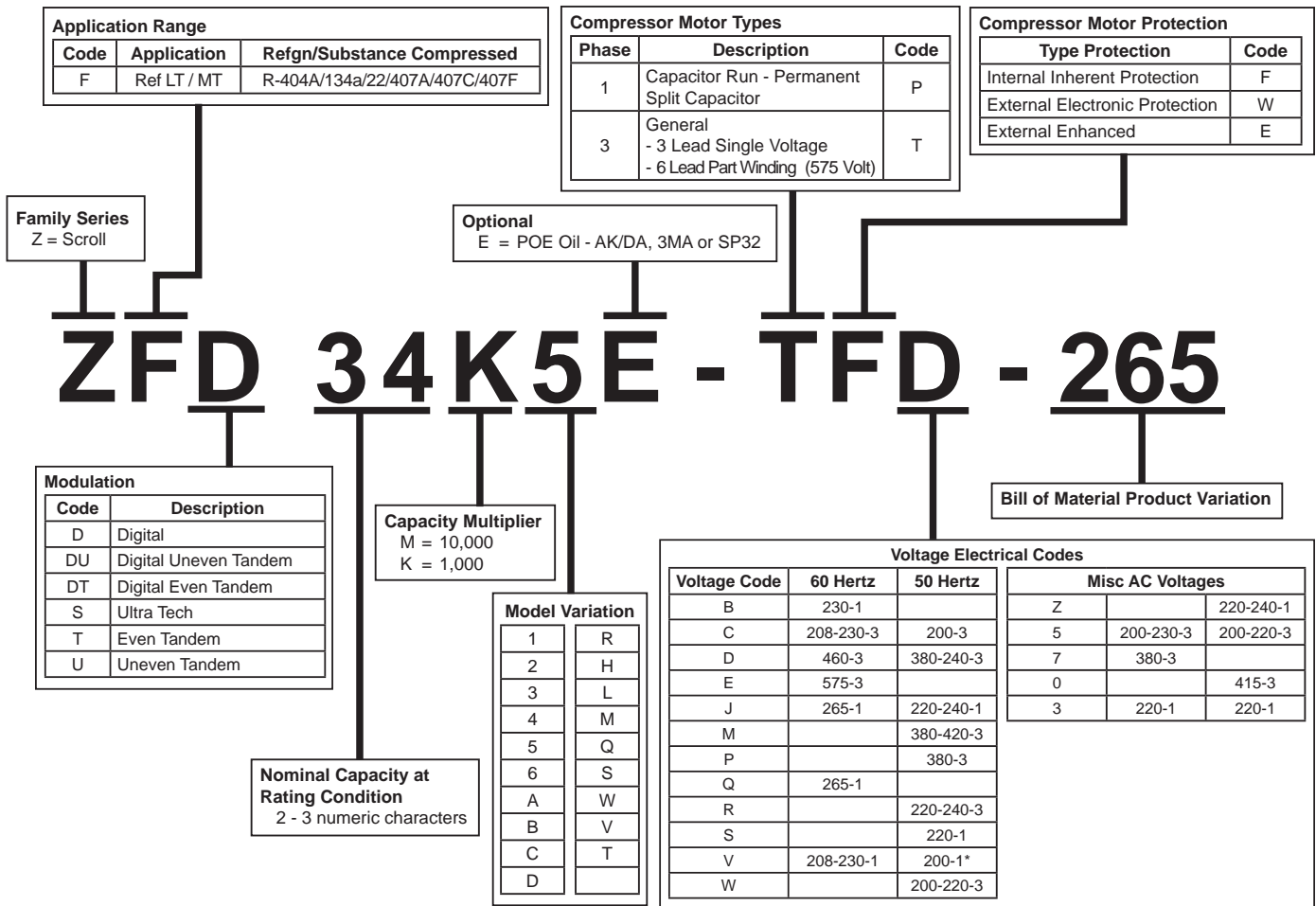

ZF – Copeland Scroll™ Compressors

Common Replacement Parts

Oil Controls and Adapters	Part Number
OMB Oil Control - All Models	065365
Oil Management Control w/ Series Relief Connector 24V, 50/60Hz	65366
Oil Management, OMB Adapter (3/4" NPT)	65668
Oil Management, OMB Adapter (1 1/4"-12 Rotalock)	66650
Injection Kit	Part Number
Scroll Demand Cooling Kit, 120V	998-1000-50
Scroll Demand Cooling Kit, 240V	998-1000-51
Cap Tube Injection Kit	Part Number
Scroll Demand Cooling Kit, 120V	998-1000-50
Scroll Demand Cooling Kit, 240V	998-1000-51
Digital Components	Part Number
IDCM With 2 Minute Anti Short Cycle Delay	543-0024-00
IDCM Without 2 Minute Anti Short Cycle Delay	543-0086-01
Solenoid Coil, 24 VAC, 12" Lead Length	923-0058-00
Solenoid Coil, 110 VAC, 63" Lead Length	923-0058-08
Solenoid Coil, 220 VAC, 63" Lead Length	923-0058-09
IDCM Without 2 Minute Anti Short Cycle Delay With T1-T2 Resistor	943-0086-00
Digital Valve & Tubing Kit, Rotalock Models	998-0066-00
Digital Valve & Tubing Kit, Stub Tube/Braze Models	998-0073-00
Closed Loop Digital Controller (Single Compressor Applications)	998-0189-00

Discharge Line Thermostat	Part Number
1/2" Discharge Line Thermostat	998-7022-02
5/8" Discharge Line Thermostat	998-7022-04
3/4" Discharge Line Thermostat	998-7022-07
Miscellaneous Parts	Part Number
Oil Sight Glass Kit - All models with sight glass	998-0010-00
Oil Adjustment (fill drain) Valve	910-0715-00
Terminal Block (T-block) Kit - includes terminal screws	921-0227-00
Molded Plug (for ZSKAE models)	529-0060-04

Crankcase Heater Notes

Note #	OEM	Service	Volts	Watts	Lead Length
4	018-0091-21	918-0047-00	120V	90 WATT	48" LEAD
	018-0091-22	918-0047-01	240V		
	018-0091-23	918-0047-02	480V		
	018-0091-24	918-0047-03	575V		
		998-7029-00		CONDUIT BOX	
5A	018-0091-06	918-0056-06	120 V	120 WATT	28" LEAD
	018-0091-04	918-0056-04	240 V		
	018-0091-05	918-0056-05	480 V		
	018-0091-07	918-0056-07	575 V		
5B	018-0091-10	918-0056-10	120 V	150 WATT	28" LEAD
	018-0091-09	918-0056-09	240 V		
	018-0091-08	918-0056-08	480 V		
	018-0091-11	918-0056-11	575 V		
6	018-0094-00	918-0052-00	240V	40 WATT	21" LEAD
	018-0094-01	918-0052-01	120V		
7	018-0095-00		240V	70 WATT	29" LEAD
	018-0095-01		480V		
	018-0095-02		575V		
	018-0095-04	918-0043-00	240V		
	018-0095-05	918-0043-01	480V		48" LEAD
	018-0095-06	918-0043-02	575V		
	018-0095-07	918-0043-07	120V		
9	018-0091-17	918-0019-01	120V	70 WATT	30" LEAD
	018-0091-18	918-0019-04	240V		
	018-0091-19	918-0019-08	460V	60 WATT	
	018-0091-15	918-0019-09	575V		
10	018-0096-02	918-0041-02	120 V	40 WATT	28" LEAD
	018-0096-00	918-0041-00	240 V		
	018-0096-01	918-041-01	480 V		
	018-0096-03	918-0041-03	575 V		



ZF – Copeland Scroll™ Compressors

ZF - Compressor Parts

Model	Start Capacitor		Run Capacitor		Relay		Motor Protec-tor	Mounting Parts (527-)	Hard Mounting Parts	CH *	Sight-glass Kit (998-)
	OEM	Service	OEM	Service	OEM	Service					
	(014-)	(914-)	(014-)	(914-)	(040-)	(940-)					
ZF06K4(E)-PFV*	0061-27	0036-03	0064-08	0037-12	0166-37	0001-79	IP	0116-00	998-0178-00	7	0010-02
ZF06K4(E)-TF*							IP	0116-00	998-0178-00	7	0010-02
ZF08K4(E)-PFV*	0061-27	0036-03	0064-25	0037-36	0116-37	0001-79	IP	0116-00	998-0178-00	7	0010-02
ZF08K4(E)-TF*							IP	0116-00	998-0178-00	7	0010-02
ZF09K4(E)-PFV*	0061-27	0036-03	0064-29	0037-40	0166-37	0001-79	IP	0116-00	998-0178-00	7	0010-02
ZF09K4(E)-TF*							IP	0116-00	998-0178-00	7	0010-02
ZF11K4(E)-PFV*	0061-27	0036-03	0064-26	0037-37	0166-37	0001-79	IP	0116-00	998-0178-00	7	0010-02
ZF11K4(E)-TF*							IP	0116-00	998-0178-00	7	0010-02
ZF13K4(E)-PFV*	0006-15	0006-10	0064-26	0037-37	0166-37	0001-79	IP	0116-00	527-0158-00	7	0010-02
ZF13K4(E)-TF*							IP	0116-00	527-0158-00	7	0010-02
ZF13KVE-TF*							IP	0116-00	527-0158-00	7	0010-02
D ZFD13KVE-TF*								0116-00	527-0158-00		0010-02
ZF15K4(E)-PFV*	0006-15	0006-10	0064-27	0037-38	0166-37	0001-79	IP	0116-00	527-0158-00	7	0010-02
ZF15K4(E)-TF*							IP	0116-00	527-0158-00	7	0010-02
ZF18K4(E)-TF*							IP	0116-00	527-0158-00	7	0010-02
ZF18KVE-TF*							IP	0116-00	527-0158-00	7	0010-02
D ZFD18KVE-TF*							IP	0116-00	527-0158-00	7	0010-02
ZF24K4(E)-TW*							NOTE 2B	0159-00	527-0158-00	9	0010-02
ZF24KVE-TW*							NOTE 2B	0159-00	527-0158-00	9	0010-02
ZF25K4E-TF*							IP	0116-00	527-0158-00	7	0010-02
ZF25KVE-TF*							IP	0116-00	527-0158-00	7	0010-02
D ZFD25KVE-TF*							IP	0116-00	527-0158-00	7	0010-02
ZF33K4(E)-TW*							NOTE 2B	0159-00	527-0158-00	9	0010-02
ZF33KVE-TW*							NOTE 2B	0159-00	527-0158-00	9	0010-02
ZF34K5E-TF*							IP	0210-00	998-0178-00	4	0010-02
ZF40K4(E)-TW*							NOTE 2B	0159-00	527-0158-00	9	0010-02
ZF40KVE-TW*							NOTE 2B	0159-00	527-0158-00	9	0010-02
ZF41K5E-TF*							IP	0210-00	998-0178-00	4	0010-02
ZF48K4(E)-TW*							NOTE 2B	0159-00	527-0158-00	9	0010-02
ZF48KVE-TW*							NOTE 2B	0159-00	527-0158-00	9	0010-02
ZF49K5E-TF*							IP	0210-00	998-0178-00	4	0010-02
ZF49K5E-TW*							NOTE 2A	0210-00	998-0178-00	4	0010-02
ZF54K5E-TF*							IP	0210-00	998-0178-00	4	0010-02
ZF54K5E-TW*							NOTE 2A	0210-00	998-0178-00	4	0010-02

D = Digital

* Crankcase Heater Note

Copeland Scroll™ CO₂ Compressors – ZO

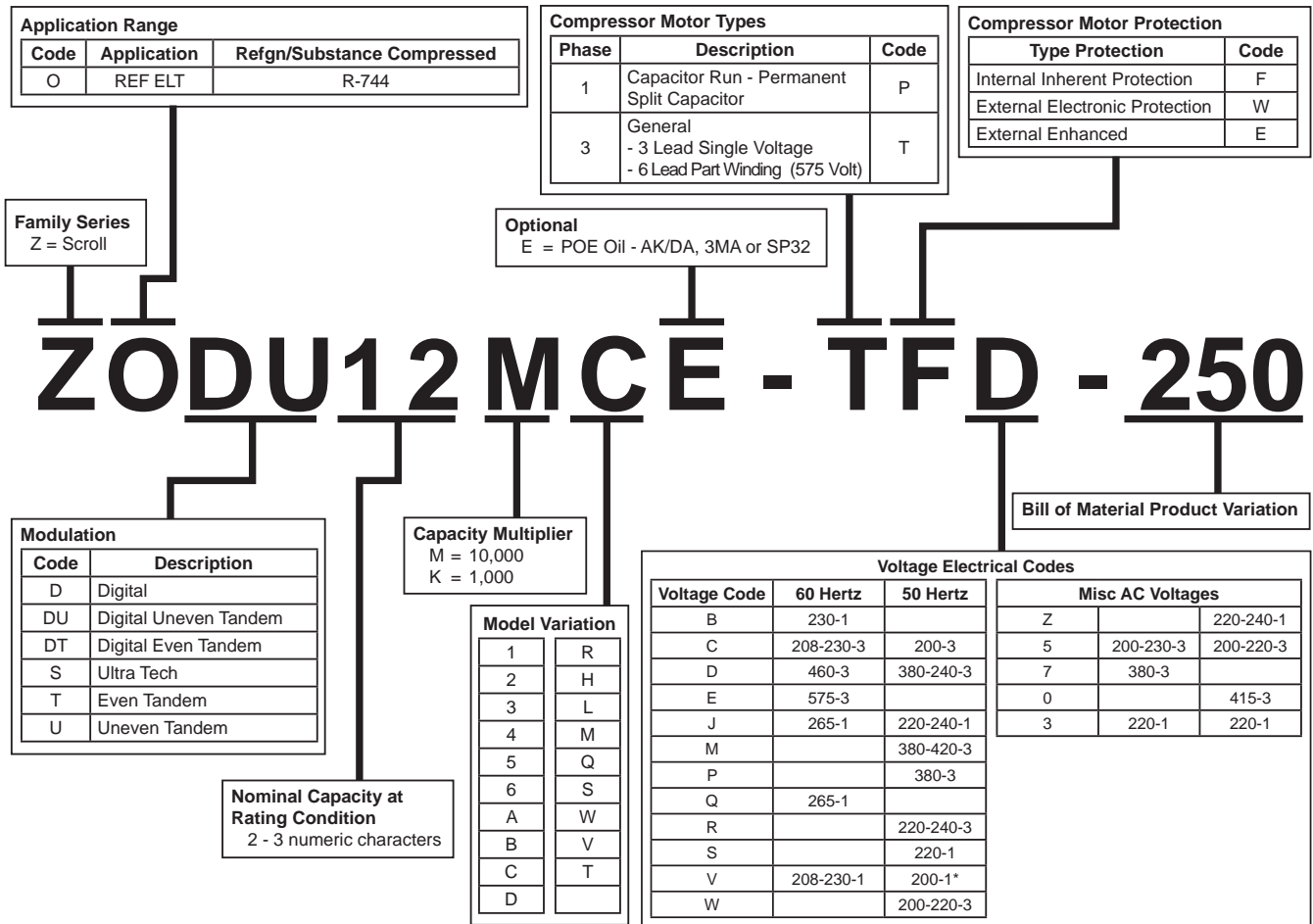

ZO – Copeland Scroll™ CO₂ Compressors

Common Replacement Parts

Oil Controls and Adapters	Part Number
O MB Oil - All Models	065365
ZOD104KCE, ZOD34K3E	Int. Thread (3/4" NPT)-065668
ZOD34K3E	Ext. Thread (1 1/4-12UNF)-066650
Oil Management Control	65365
O MB Adapters	Sight Glass Connection-Part #
ZO88/104KCE, ZO34K3E, ZO34K3E-ZO58K3E	(3/4" NPT) 65668
ZO88/104KCE, ZO34K3E, ZO34K3E-ZO58K3E	Oil Management, OMB Adapter (1 1/4"-12 Rotalock) 66650
Discharge Line Thermostat	Part Number
1/2" Discharge Line Thermostat	998-0540-02
5/8" Discharge Line Thermostat	998-7022-04
3/4" Discharge Line Thermostat	998-0548-01
Digital Components	Part Number
Solenoid Coil, 24 VAC, 12" Lead Length	923-0058-00
Solenoid Coil, 110 VAC, 63" Lead Length	923-0058-08
Solenoid Coil, 220 VAC, 63" Lead Length	923-0058-09
DCM without 2 minute anti-short-cycle delay with T1-T2 resistor	943-0086-00
Digital Valve & Tubing Kit, Rotalock Models	998-0066-00
Miscellaneous Parts	Part Number
ALL REF SCROLL SG KIT	998-0010-02
Dual High and Low Pressure Cut-Out Control	085-CP2M-7K
Suction High Pressure Pop Off Valve (500 psi)	510-0730-01
Oil Sight Glass Kit - All models with sightglass	998-0010-02
Oil Adjustment Valve Kit	910-0715-00
Suction High Pressure Pop Off Valve (500 psi)	510-0730-01
1 Gallon Can Ultra RL68HB CO2 Oil - US	998-E068-01

Crankcase Heater Notes

Note #	OEM	Service	Volts	Watts	Lead Length
6	018-0094-01	918-0052-01	120V	40 WATT	21" LEAD
	018-0094-00	918-0052-00	240V		
7	018-0095-00		240V	70 WATT	29" LEAD
	018-0095-01		480V		
	018-0095-02		575V		
	018-0095-04	918-0043-00	240V		48" LEAD
	018-0095-05	918-0043-01	480V		
	018-0095-06	918-0043-02	575V		
	018-0095-07	918-0043-07	120V		

Copeland Scroll™ CO₂ Compressors – ZO

ZO Compressor Parts

Model	Motor Protector	Mounting Parts	Hard Mounting Parts	Crankcase Heater	Sight-Glass Kit
		(527-)			(998-)
ZO21K5E-TF5	IP	0044-15		6	0010-02
ZO21K5E-TF7	IP	0044-15		6	0010-02
ZO21K5E-TFD	IP	0044-15		6	0010-02
ZO34K3E-TF5	IP	0116-00	998-0178-00	7	0010-02
ZO34K3E-TF7	IP	0116-00	998-0178-00	7	0010-02
ZO34K3E-TFD	IP	0116-00	998-0178-00	7	0010-02
ZO34K3E-TFE	IP	0116-00	998-0178-00	7	0010-02
ZOD34K3E-TF5	IP	0116-00	998-0178-00	7	0010-02
ZOD34K3E-TF7	IP	0116-00	998-0178-00	7	0010-02
ZOD34K3E-TFD	IP	0116-00	998-0178-00	7	0010-02
ZOD34K3E-TFE	IP	0116-00	998-0178-00	7	0010-02
ZO45K3E-TF5	IP	0116-00	998-0178-00	7	0010-02
ZO45K3E-TFD	IP	0116-00	998-0178-00	7	0010-02
ZO45K3E-TFE	IP	0116-00	998-0178-00	7	0010-02
ZO58K3E-TF7	IP	0116-00	998-0178-00	7	0010-02
ZO58K3E-TFD	IP	0116-00	998-0178-00	7	0010-02
ZO58K3E-TFE	IP	0116-00	998-0178-00	7	0010-02
ZO88KCE-TF5	IP	0116-00	527-0158-00	7	0010-02
ZO88KCE-TF7	IP	0116-00	527-0158-00	7	0010-02
ZO88KCE-TFD	IP	0116-00	527-0158-00	7	0010-02
ZO88KCE-TFE	IP	0116-00	527-0158-00	7	0010-02
ZO104KCE-TF5	IP	0116-00	527-0158-00	7	0010-02
ZO104KCE-TF7	IP	0116-00	527-0158-00	7	0010-02
ZO104KCE-TFD	IP	0116-00	527-0158-00	7	0010-02
ZO104KCE-TFE	IP	0116-00	527-0158-00	7	0010-02
ZOD104KCE-TF5	IP	0116-00	527-0158-00	7	0010-02
ZOD104KCE-TF7	IP	0116-00	527-0158-00	7	0010-02
ZOD104KCE-TFE	IP	0116-00	527-0158-00	7	0010-02

ZP – Copeland Scroll™ Compressors

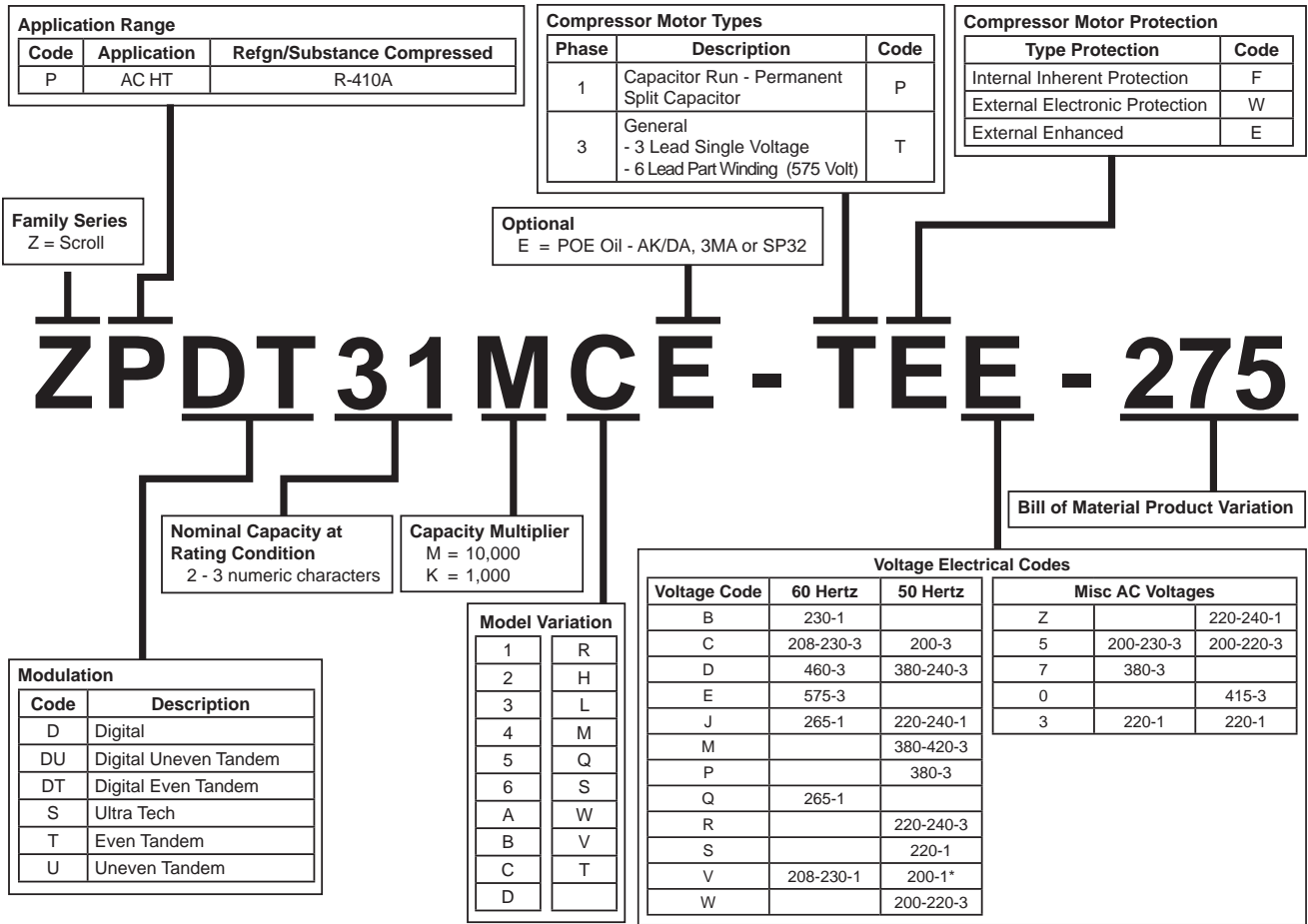

Common Replacement Parts

Molded Plug	Part Number
10 GA. - All K4/K4E and K5/K5E 130 or 830 BOM compressors	529-0060-04
Miscellaneous Parts	Part Number
Oil Sight Glass Kit - All models with sight glass	998-0010-00
Oil Adjustment (fill drain) Valve	910-0715-00
Terminal Block (T-block) Kit - includes terminal screws	921-0227-00

Motor Protector Modules

Note #	OEM	Service	Voltage
2A	071-0660-01	971-0641-01	24V
2A	071-0660-00	971-0641-00	120/240V
2D	071-0649-01	998-0520-04	24V
2D	071-0649-00	998-0520-00	120/240V

CoreSense Communication Motor Protector

Note #	OEM	Service	Voltage
3	571-0064-06	971-0064-05	120/240V
3	571-0065-05	971-0065-04	24V

Crankcase Heater Notes

Note #	OEM	Service	Volts	Watts	Lead Length
4	018-0091-21	918-0047-00	120V	90 WATT	48" LEAD
	018-0091-22	918-0047-01	240V	90 WATT	
	018-0091-23	918-0047-02	480V	90 WATT	
	018-0091-24	918-0047-03	575V	90 WATT	
	998-7029-00	CONDUIT BOX			
5A	018-0091-06	918-0056-06	120V	120 WATT	28" LEAD
	018-0091-04	918-0056-04	240V	120 WATT	
	018-0091-05	918-0056-05	480V	120 WATT	
	018-0091-07	918-0056-07	575V	120 WATT	
5B	018-0091-10	918-0056-10	120V	150 WATT	28" LEAD
	018-0091-09	918-0056-09	240V	150 WATT	
	018-0091-08	918-0056-08	480V	150 WATT	
	018-0091-11	918-0056-11	575V	150 WATT	
6	018-0094-01	918-0052-01	120V	40 WATT	21" LEAD
	018-0094-00	918-0052-00	240V	40 WATT	
7	018-0095-00		240V	70 WATT	29" LEAD
	018-0095-01		480V	70 WATT	
	018-0095-02		575V	70 WATT	
	018-0095-07	918-0043-07	120V	70 WATT	48" LEAD
	018-0095-04	918-0043-00	240V	70 WATT	
	018-0095-05	918-0043-01	480V	70 WATT	
	018-0095-06	918-0043-02	575V	70 WATT	
9	018-0091-17	918-0019-01	120V	70 WATT	30" LEAD
	018-0091-18	918-0019-04	240V	70 WATT	
	018-0091-19	918-0019-08	460V	70 WATT	
	018-0091-15	918-0019-09	575V	60 WATT	
13	018-0096-02	918-0041-02	120V	40 WATT	28" LEAD
	018-0096-00	918-0041-00	240V	40 WATT	
	018-0096-01	918-0041-01	480V	40 WATT	
	018-0096-03	918-0041-03	575V	40 WATT	

ZP – Copeland Scroll™ Compressors

ZP - Compressor Parts

Model	Start Capacitor		Run Capacitor		Relay		Motor Protector	Mounting Parts (527-)	Crankcase Heater
	OEM	Service	OEM	Service	OEM	Service			
	(014-)	(914-)	(014-)	(914-)	(040-)	(940-)			
D ZPDT12MCE-TF*							IP	0150-00	7
D ZPDU13MCE-TFD							IP	0150-00	7
ZP14K5E-PFV*	0061-27	0036-03	0064-06	0037-10	0166-07	0140-08	IP	0044-15	6
ZP16K3E-PFV*	0061-27	0036-03	0064-08	0037-12	0166-37	0001-79	IP	0116-00	7
ZP16K5E-PFV*	0061-27	0036-03	0064-08	0037-12	0166-37	0001-79	IP	0116-00	6
D ZPDT16MCE-TF*							IP	0150-00	7
D ZPDT18MCE-TF*							IP	0150-00	7
ZP20K3E-PFV*	0061-27	0036-03	0064-07	0037-11	0166-37	0001-79	IP	0116-00	7
ZP20K3E-TF*							IP	0116-00	6
ZP20K5E-PFV*	0061-27	0036-03	0064-07	0037-11	0166-37	0001-79	IP	0116-00	6
ZP20K5E-TF*							IP	0044-15	6
ZP21K5E-PFV*	0061-27	0036-03	0064-08	0037-12	0166-37	0001-79	IP	0116-00	6
ZP21K5E-TF*							IP	0044-15	6
D ZPDT21MCE-TF*							IP	0177-00	4
ZP22KCE-PFV*	0061-27	0036-03	0064-08	0037-12	0166-37	0001-79	IP	0116-00	7
ZP23K3E-PFV*	0061-27	0036-03	0064-08	0037-12	0166-37	0001-79	IP	0116-00	7
ZP23K3E-TF*							IP	0116-00	7
ZP24K5E-PFV*	0061-27	0036-03	0064-08	0037-12	0166-37	0001-79	IP	0044-15	6
ZP24K5E-TF*							IP	0044-15	6
D ZPDT24MCE-TF*							IP	0177-00	4
ZP25K5E-PFV*	0061-27	0036-03	0064-08	0037-12	0166-37	0001-79	IP	0044-15	6
ZP25K5E-TF*							IP	0044-15	6
ZP26K3E-PFV*	0061-27	0036-03	0064-25	0037-36	0166-37	0001-79	IP	0116-00	7
ZP26K3E-TF*							IP	0116-00	7
ZP26KCE-PFV*	0061-27	0036-03	0064-13	0037-17	0166-37	0001-79	IP	0116-00	7
D ZPDT27MCE-TF*							IP	0177-00	4
ZP28K5E-PFV*	0061-27	0036-03	0064-25	0037-36	0166-37	0001-79	IP	0044-15	6
ZP28K5E-TF*							IP	0044-15	6
ZP29K5E-PFV*	0061-27	0036-03	0064-25	0037-36	0166-37	0001-79	IP	0044-15	6
ZP29K5E-TF*							IP	0044-15	6
ZP31K5E-PFV*	0061-27	0036-03	0064-25	0037-36	0166-37	0001-79	IP	0044-15	6
ZP31K5E-TF*							IP	0044-15	6
D ZPDT31MCE-TE*							EP	0177-00	4
ZP32K3E-PFV*	0061-27	0036-03	0064-25	0037-36	0166-37	0001-79	IP	0116-00	7
ZP32K3E-TF*							IP	0116-00	7
ZP32KCE-PFV*			0064-14	0037-18			IP	0116-00	7
ZP34K5E-PFV*	0061-27	0036-03	0064-25	0037-36	0166-37	0001-79	IP	0116-00	13
ZP34K5E-TF*							IP	0116-00	13
D ZPD34K5E-TF*							IP	0116-00	13
ZP36K3E-PFV*	0061-27	0036-03	0064-28	0037-39	0166-37	0001-79	IP	0116-00	7
ZP36K3E-TF*							IP	0116-00	7
ZP36K5E-PFV*	0061-27	0036-03	0064-25	0037-36	0166-37	0001-79	IP	0116-00	13
ZP36K5E-TF*							IP	0116-00	13
D ZPDT36MCE-TE*							EP	0177-00	4
ZP38K3E-PFV*	0061-27	0036-03	0064-28	0037-39	0166-37	0001-79	IP	0116-00	7
ZP38K3E-TF*							IP	0116-00	7
ZP38K5E-PFV*	0061-27	0036-03	0064-25	0037-36	0166-37	0001-79	IP	0116-00	13
ZP38K5E-TF*							IP	0116-00	13
ZP38KCE-PFV*	0061-27	0036-03	0064-14	0037-18	0166-37	0001-79	IP	0116-00	7
ZP39K5E-PFV*	0061-27	0036-03	0064-25	0037-36	0166-37	0001-79	IP	0116-00	13

D = Digital

ZP - Compressor Parts

Model	Start Capacitor		Run Capacitor		Relay		Motor Protector	Mounting Parts (527-)	Crankcase Heater
	OEM	Service	OEM	Service	OEM	Service			
	(014-)	(914-)	(014-)	(914-)	(040-)	(940-)			
ZP39K5E-TF*							IP	0116-00	13
ZP41K3E-PFV*	0061-27	0036-03	0064-26	0037-37	0166-37	0001-79	IP	0116-00	7
ZP41K3E-TF*							IP	0116-00	7
ZP42K5E-PFV*	0061-27	0036-03	0064-34	0037-51	0166-37	0001-79	IP	0116-00	13
ZP42K5E-TF*							IP	0116-00	13
D ZPDU42MCE-TE*							EP	0213-00	N/A
ZP44K3E-PFV*	0061-27	0036-03	0064-26	0037-37	0166-37	0001-79	IP	0116-00	7
ZP44K3E-TF*							IP	0116-00	7
ZP44K5E-PFV*	0061-27	0036-03	0064-34	0037-51	0166-37	0001-79	IP	0116-00	13
D ZPD42K5E-PFV*	0061-27	0036-03	0057-01	0037-38	0166-37	0001-79	IP	0116-00	N/A
D ZPD42K5E-PFZ	0061-27	0036-03	0064-27	0037-38	0166-37	0001-79	IP	0116-00	N/A
D ZPD42K5E-TF*							IP	0116-00	13
ZP44K5E-TF*							IP	0116-00	13
ZP44KCE-PFV*	0061-27	0036-03	0064-29	0037-40	0166-37	0001-79	IP	0116-00	7
ZP49K5E-PFV*	0061-27	0036-03	0064-34	0037-51	0166-37	0001-79	IP	0116-00	13
ZP49K5E-TF*							IP	0116-00	13
ZP50K3E-PFV*	0006-15	0006-10	0064-27	0037-38	0166-37	0001-79	IP	0116-00	7
ZP50K3E-TF*							IP	0116-00	7
ZP51K5E-PFV*	0061-27	0036-03	0064-34	0037-51	0166-37	0001-79	IP	0116-00	13
ZP51K5E-TF*							IP	0116-00	13
D ZPD51K5E-PF*	0061-27	0036-03	0057-01	0037-51	0166-37	0001-79	IP	0116-00	13
D ZPD51K5E-TF*							IP	0116-00	13
ZP54K3E-PFV*	0006-15	0006-10	0064-27	0037-38	0166-37	0001-79	IP	0116-00	7
ZP54K3E-TF*							IP	0116-00	7
ZP54K5E-PFV*	0061-27	0036-03	0064-27	0037-38	0166-37	0001-79	IP	0116-00	13
D ZPD54K5E-PFV	0061-27	0036-03	0057-01	0037-38	0166-37	0001-79	IP	0116-00	13
ZP54K5E-TF*							IP	0116-00	13
D ZPD54K5E-TF*							IP	0116-00	13
ZP57K3E-PFV*	0006-15	0006-10	0064-27	0037-38	0166-37	0001-79	IP	0116-00	7
ZP57K3E-TF*							IP	0116-00	7
ZP57K5E-PFV*	0061-27	0036-03	0064-27	0037-38	0166-37	0001-79	IP	0116-00	13
ZP57K5E-TF*							IP	0116-00	13
ZP57KCE-PFV*	0006-15	0006-10	0064-27	0037-38	0166-37	0001-79	IP	0116-00	7
ZP57KCE-TF*							IP	0116-00	7
ZP61K5E-PFV*	0061-27	0036-03	0064-27	0037-38	0166-37	0001-79	IP	0116-00	13
ZP61K5E-TF*							IP	0116-00	13
ZP61KCE-TF*							IP	0116-00	7
D ZPD61KCE-TFE*							IP	0116-00	7
D ZPD61KCE-TF0*							IP	0221-00	N/A
D ZPD61KCE-TF5							IP	0116-00	7
ZP67KCE-PFV*	0006-15	0006-10	0064-35	0037-52	0166-28	0001-69	IP	0116-00	7
ZP67KCE-TF*							IP	0116-00	7
D ZPD67KCE-PFZ*	0006-17		0064-40		0166-28		IP	0116-00	7
ZP70KWE-PFV*	0006-15	0006-10	0064-27	0037-38	0166-37	0001-79	IP	0116-00	7
ZP72KCE-PFV*	0006-15	0006-10	0064-35	0037-52	0166-28	0001-69	IP	0116-00	7
ZP72KCE-TF*							IP	0116-00	7
D ZPD72KCE-TF0							IP	0116-00	7
ZP76KCE-TF*							IP	0116-00	7
ZP83KCE-TF*							IP	0116-00	7
D ZPD83KCE-TFD*							IP	0116-00	7

D = Digital

ZP – Copeland Scroll™ Compressors

ZP - Compressor Parts

Model	Start Capacitor		Run Capacitor		Relay		Motor Protector	Mounting Parts (527-)	Crankcase Heater
	OEM	Service	OEM	Service	OEM	Service			
	(014-)	(914-)	(014-)	(914-)	(040-)	(940-)			
D ZPD83KCE-TFE							IP	0116-00	7
D ZPD83KCE-TF5							IP	0116-00	7
D ZPD83KCE-TF7							IP	0116-00	7
D ZPD83KCE-TF0							IP	0221-00	N/A
ZP83KWE-PFV*	0053-30	0053-14	0064-35	0037-52	0166-02	0140-03	IP	0116-00	7
ZP83KWE-TF*							IP	0116-00	7
ZP90KCE-TF*							IP	0116-00	4
ZP91KCE-TF*							IP	0221-00	7
D ZPD91KCE-TF*							IP	0116-00	7
ZP103KCE-TF*							IP	0210-00	4
D ZPD103KCE-TF*							IP	0116-00	4
D ZPD103KCE-TF*							IP	0116-00	4
ZP104KCE-TF*							IP	0221-00	7
ZP120KCE-TF*							IP	0210-00	4
D ZPD120KCE-TF*							IP	0116-00	4
ZP122KCE-TF*							IP	0221-00	7
ZP137KCE-TF*							IP	0210-00	4
D ZPD137KCE-TF*							IP	0116-00	4
ZP154KCE-TE*							NOTE 3	0210-00	4
ZP154KCE-TW*							NOTE 2D	0210-00	4
D ZPD154KCE-TE*							EP	0210-00	4
D ZPD154KCE-TF*							IP	0210-00	4
ZP180KCE-TW*							NOTE 2A	0159-00	9
ZP181KCE-TW*							NOTE 2D	0210-00	4
D ZPD181KCE-TE*							EP	0210-00	4
ZP182KCE-TE*							NOTE 3	0210-00	4
ZP182KCE-TW*							NOTE 2D	0210-00	4
D ZPD182KCE-TE*							EP	0210-00	4
D ZPD182KCE-TF*							IP	N/A	N/A
ZP235KCE-TE*							NOTE 3	0175-02	5A
ZP235KCE-TW*							NOTE 2A	0175-02	5A
ZP236KCE-TE*							NOTE 2C	0175-02	5A
ZP285KCE-TE*							NOTE 3	0175-00	5B
ZP285KCE-TW*							NOTE 2A	0175-00	5B
ZP295KCE-TE*							NOTE 3	0175-00	5B
ZP295KCE-TW*							NOTE 2A	0175-02	5B
ZP296KCE-TE*							NOTE 3	0175-02	5A
ZP385KCE-TE*							NOTE 3	0175-02	5B
ZP385KCE-TW*							NOTE 2A	0175-02	5B
ZP485KCE-TE*							NOTE 3	0175-02	5B
ZP485KCE-TW*							NOTE 2A	0175-02	5B
ZPS20K4E-PFV*	0061-27	0036-03	0064-35	0037-52	0166-07	0140-08	IP	0116-00	7
ZPS20K4E-TF*							IP	0116-00	7
ZPS20K5E-PFV*	0061-27	0036-03	0064-07	0037-11	0166-37	0001-79	IP	0044-15	6
ZPS20K5E-TF*							IP	0044-15	6
ZPS21K5E-PFV*	0061-27	0036-03	0064-07	0037-11	0166-37	0001-79	IP	0044-15	6
ZPS25K4E-TF*							IP	0116-00	7
ZPS26K4E-PFV*	0061-27	0036-03	0064-08	0037-12	0166-21	0001-62	IP	0116-00	7
ZPS26K4E-TF*							IP	0116-00	7
ZPS26K5E-PFV*	0061-27	0036-03	0064-08	0037-12	0166-37	0001-79	IP	0044-15	6

D = Digital

ZP - Compressor Parts

Model	Start Capacitor		Run Capacitor		Relay		Motor Protector	Mounting Parts (527-)	Crankcase Heater
	OEM	Service	OEM	Service	OEM	Service			
	(014-)	(914-)	(014-)	(914-)	(040-)	(940-)			
ZPS26K5E-TF*							IP	0044-15	6
ZPS30K3E-PFV*	0061-27	0036-03	0064-12	0037-16	0166-07	0140-08	IP	0116-00	7
ZPS30K4E-PFV*	0061-27	0036-03	0064-08	0037-12	0166-21	0001-62	IP	0116-00	7
ZPS30K4E-TF*							IP	0116-00	7
ZPS30K5E-PFV*	0061-27	0036-03	0064-08	0037-12	0166-37	0001-79	IP	0044-15	6
ZPS30K5E-TF*							IP	0044-15	6
ZPS31K5E-PFV*	0061-27	0036-03	0064-08	0037-12	0166-37	0001-79	IP	0044-15	6
ZPS35K4E-PFV*	0061-27	0036-03	0064-25	0037-36	0166-37	0001-79	IP	0116-00	7
ZPS35K4E-TF*							IP	0116-00	7
ZPS35K5E-PFV*	0061-27	0036-03	0064-25	0037-36	0166-37	0001-79	IP	0116-00	13
ZPS35K5E-TF*							IP	0116-00	13
ZPS40K3E-PFV*	0061-27	0036-03	0064-14	0037-18	0166-37	0001-79	IP	0116-00	7
ZPS40K4E-PFV*	0061-27	0036-03	0064-25	0037-36	0166-37	0001-79	IP	0116-00	7
ZPS40K4E-TF*							IP	0116-00	7

D = Digital

Advanced Scroll Temperature Protection (ASTP), a feature to guard scroll compressors from overheating.

ASTP MODELS		
ZB50	-	ZR84
ZB58	ZP90	ZR94
ZB66	ZP103	ZR108
ZB76	ZP120	ZR125
ZB88	ZP137	ZR144
ZB95	ZP154	ZR160
ZB114	ZP182	ZR190

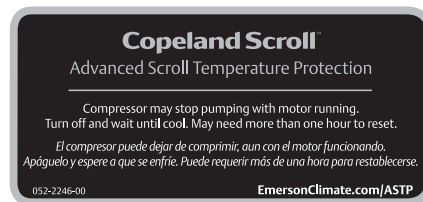

ZP – Copeland Scroll™ Compressors

ZPS - Compressor Parts

Model	Start Capacitor		Run Capacitor		Relay		Motor Protec-tor	Mounting Parts	Crankcase Heater
	OEM	Service	OEM	Service	OEM	Service			
	(014-)	(914-)	(014-)	(914-)	(040-)	(940-)		(527-)	
ZPS40K5E-PFV*	0061-27	0036-03	0064-06	0037-10	0166-02	0140-03	IP	0116-00	13
ZPS40K5E-TF*							IP	0116-00	13
ZPS49K4E-PFV*	0006-15	0006-10	0064-27	0037-38	0166-07	0140-08	IP	0116-00	7
ZPS49K4E-TF*							IP	0116-00	7
ZPS49K5E-PFV*	0061-27	0036-03	0064-14	0037-18	0166-02	0140-03	IP	0116-00	13
ZPS49K5E-TF*							IP	0116-00	13
ZPS51K4E-PFV*	0006-15	0006-10	0064-27	0037-38	0166-07	0140-08	IP	0116-00	7
ZPS51K4E-TF*							IP	0116-00	7
ZPS51K5E-PFV*	0061-27	0036-03	0064-14	0037-18	0166-02	0140-03	IP	0116-00	13
ZPS51K5E-TF*							IP	0116-00	13
ZPS60K4E-PFV*	0006-15	0006-10	0064-27	0037-38	0166-07	0140-08	IP	0116-00	7
ZPS60K4E-TF*							IP	0116-00	7
ZPS60K5E-PFV*	0053-38	0053-07	0064-14	0037-18	0166-02	0140-03	IP	0116-00	13
ZPS60K5E-TF*							IP	0116-00	13

ZPT - Compressor Parts

Model	Mounting Parts		For Crankcase Heaters and Start Components, see Compressor
	Compressor to Rails	Rails to Mounting Surface	
ZPT88K5E-TF*	527-0212-00	527-0150-00	ZP44K5E
ZPT98K5E-PFV*	527-0212-00	527-0150-00	ZP49K5E
ZPT98K5E-TF*	527-0212-00	527-0150-00	ZP49K5E
ZPT100K3E-TF*	527-0181-00	527-0150-00	ZP50K3E
ZPT108K3E-TF*	527-0181-00	527-0150-00	ZP54K3E
ZPT108K5E-PFV*	527-0212-00	527-0150-00	ZP54K5E
ZPT108K5E-TF*	527-0212-00	527-0150-00	ZP54K5E
ZPT114K3E-PFV*	527-0181-00	527-0150-00	ZP57K3E
ZPT114K3E-TF*	527-0181-00	527-0150-00	ZP57K3E
ZPT114K5E-PFV*	527-0181-00	527-0150-00	ZP57K5E
ZPT114K5E-TF*	527-0181-00	527-0150-00	ZP57K5E
ZPT122K5E-PFV*	527-0181-00	527-0150-00	ZP61K5E
ZPT122K5E-TF*	527-0181-00	527-0150-00	ZP61K5E
ZPT122KCE-TF*	527-0181-00	527-0150-00	ZP61KCE
ZPT134KCE-TF*	527-0181-00	527-0150-00	ZP67KCE
ZPT144KCE-TF*	527-0181-00	527-0150-00	ZP72KCE
ZPT152KCE-TF*	527-0181-00	527-0150-00	ZP76KCE
ZPT166KCE-TF*	527-0181-00	527-0150-00	ZP83KCE
ZPT180KCE-TF*	027-0385-00	527-0177-00	ZP90KCE
ZPT182KCE-TF*	527-0181-00	527-0150-00	ZP91KCE
ZPT206KCE-TF*	027-0385-00	527-0177-00	ZP103KCE
ZPT208KCE-TF*	027-0385-00	527-0177-00	ZP104KCE
ZPT240KCE-TF*	027-0385-00	527-0177-00	ZP120KCE
ZPT244KCE-TF*	027-0385-00	527-0177-00	ZP122KCE

ZPT - Compressor Parts

Model	Mounting Parts		For Crankcase Heaters and Start Components, see Compressor
	Compressor to Rails	Rails to Mounting Surface	
ZPT274KCE-TF*	027-0385-00	527-0177-00	ZP137KCE
ZPT308KCE-TE*	027-0385-00	527-0177-00	ZP154KCE-TE*
ZPT308KCE-TW*	027-0385-00	527-0177-00	ZP154KCE-TW*
ZPT360KCE-TW*	527-0166-00	527-0177-00	ZP180KCE
ZPT364KCE-TE*	027-0385-00	527-0177-00	ZP182KCE-TE*
ZPT364KCE-TW*	027-0385-00	527-0177-00	ZP182KCE-TW*
ZPT470KCE-TE*	527-0178-00	N/A	ZP235KCE-TE*
ZPT470KCE-TW*	527-0178-00	N/A	ZP235KCE-TW*
ZPT472KCE-TE*	527-0178-00	N/A	ZP236KCE-TE*
ZPT570KCE-TE*	527-0178-00	N/A	ZP285KCE-TE*
ZPT570KCE-TW*	527-0178-00	N/A	ZP285KCE-TW*
ZPT590KCE-TE*	527-0178-00	N/A	ZP295KCE-TE*
ZPT590KCE-TW*	527-0178-00	N/A	ZP295KCE-TW*
ZPT592KCE-TE*	527-0178-00	N/A	ZP296KCE-TE*
ZPT770KCE-TE*	527-0178-00	N/A	ZP385KCE-TE*
ZPT770KCE-TW*	527-0178-00	N/A	ZP385KCE-TW*
ZPT970KCE-TE*	527-0178-00	N/A	ZP485KCE-TE*
ZPT970KCE-TW*	527-0178-00	N/A	ZP485KCE-TW*

ZPU - Uneven Tandems

Model	Motor Protector	Mounting Parts	Crankcase Heater	Model	Motor Protector	Mounting Parts	Crankcase Heater
		(527-)				(527-)	
ZPU223KCE-TFD	IP	0177-00	4	ZPU336KCE-TE5	EP	0177-00	4
ZPU223KCE-TFE	IP	0177-00	4	ZPU336KCE-TE7	EP	0177-00	4
ZPU223KCE-TF5	IP	0177-00	4	ZPU417KCE-TEC	EP	0213-00	4
ZPU223KCE-TF7	IP	0177-00	4	ZPU417KCE-TED	EP	0213-00	4
ZPU240KCE-TFD	IP	0177-00	4	ZPU417KCE-TEE	EP	0213-00	4
ZPU240KCE-TFE	IP	0177-00	4	ZPU417KCE-TE7	EP	0213-00	4
ZPU240KCE-TF5	IP	0177-00	4	ZPU418KCE-TED	EP	0213-00	
ZPU240KCE-TF7	IP	0177-00	4	ZPU418KCE-TEE	EP	0213-00	
ZPU257KCE-TFD	IP	0177-00	4	ZPU418KCE-TE5	EP	0213-00	
ZPU257KCE-TFE	IP	0177-00	4	ZPU418KCE-TE7	EP	0213-00	
ZPU257KCE-TF5	IP	0177-00	4	ZPU870KWE-TED	EP	0213-00	
ZPU257KCE-TF7	IP	0177-00	4	ZPU870KWE-TEE	EP	0177-00	
ZPU336KCE-TED	EP	0177-00	4	ZPU870KWE-TE7	EP	0178-00	
ZPU336KCE-TEE	EP	0177-00	4				

ZR – Copeland Scroll™ Compressors

Application Range		
Code	Application	Refgn/Substance Compressed
R	AC	R-22/407C/134a

Compressor Motor Types		
Phase	Description	Code
1	Capacitor Run - Permanent Split Capacitor	P
3	General - 3 Lead Single Voltage - 6 Lead Part Winding (575 Volt)	T

Compressor Motor Protection	
Type Protection	Code
Internal Inherent Protection	F
External Electronic Protection	W
External Enhanced	E

Family Series
Z = Scroll

Optional
E = POE Oil - AK/DA, 3MA or SP32

ZRDU12MCE - TFD - 250

Modulation	
Code	Description
D	Digital
DU	Digital Uneven Tandem
DT	Digital Even Tandem
S	Ultra Tech
T	Even Tandem
U	Uneven Tandem

Capacity Multiplier
M = 10,000
K = 1,000

Model Variation	
1	R
2	H
3	L
4	M
5	Q
6	S
A	W
B	V
C	T
D	

Nominal Capacity at Rating Condition
2 - 3 numeric characters

Voltage Electrical Codes			
Voltage Code	60 Hertz		Misc AC Voltages
	230-1	200-3	
B	230-1		Z
C	208-230-3	200-3	5
D	460-3	380-240-3	7
E	575-3		0
J	265-1	220-240-1	3
M		380-420-3	
P		380-3	
Q	265-1		
R		220-240-3	
S		220-1	
V	208-230-1	200-1*	
W		200-220-3	

Bill of Material Product Variation



Common Replacement Parts

Molded Plug	Part Number
10 GA. - All K4/K4E and K5/K5E 130 or 830 BOM compressors	529-0060-04
Miscellaneous Parts	Part Number
Oil Sight Glass Kit - All models with sight glass	998-0010-00
Oil Adjustment (fill drain) Valve	910-0715-00
Terminal Block (T-block) Kit - includes terminal screws	921-0227-00
Digital Components	Part Number
Digital Copressor Controller	543-0024-01

Motor Protector Modules

Note #	OEM	Service	Voltage
2A	071-0660-01	971-0641-01	24V
2A	071-0660-00	971-0641-00	120/240V
2D	071-0649-01	998-0520-04	24V
2D	071-0649-00	998-0520-00	120/240V

CoreSense Communication Motor Protector

Note #	OEM	Service	Voltage
3	571-0064-06	971-0064-05	120/240V
3	571-0065-05	971-0065-04	24V

Crankcase Heater Notes

Note #	OEM	Service	Volts	Watts	Lead Length
4	018-0091-21	918-0047-00	120 V	90 WATT	48"LEAD
	018-0091-22	918-0047-01	240 V		
	018-0091-23	918-0047-02	480V		
	018-0091-24	918-0047-03	575 V		
	998-7029-00	CONDUIT BOX			
5A	018-0091-06	918-0056-06	120V	120 WATT	28"LEAD
	018-0091-04	918-0056-04	240V		
	018-0091-05	918-0056-05	480V		
	018-0091-07	918-0056-07	575V		
5B	018-0091-10	918-0056-10	120V	150 WATT	28"LEAD
	018-0091-09	918-0056-09	240V		
	018-0091-08	918-0056-08	480V		
	018-0091-11	918-0056-11	575V		
6	018-0094-01	918-0052-01	120V	40 WATT	21" LEAD
	018-0094-00	918-0052-00	240V		
7	018-0095-00		240V	70 WATT	29" LEAD
	018-0095-01		480V		
	018-0095-02		575V		
	018-0095-07	918-0043-07	120V		48" LEAD
	018-0095-04	918-0043-00	240V		
	018-0095-05	918-0043-01	480V		
	018-0095-06	918-0043-02	575V		
9	018-0091-17	918-0019-01	120V	70 WATT	30" LEAD
	018-0091-18	918-0019-04	240V		
	018-0091-19	918-0019-08	460V		
	018-0091-15	918-0019-09	575V	60 WATT	
13	018-0096-02	918-0041-02	120V	40 WATT	28"LEAD
	018-0096-00	918-0041-00	240V		
	018-0096-01	918-0041-01	480V		
	018-0096-03	918-0041-03	575V		

ZR – Copeland Scroll™ Compressors

ZR - Compressor Parts

Model	Start Capacitor		Run Capacitor		Relay		Motor Protector	Mounting Parts (527-)	Crankcase Heater
	OEM	Service	OEM	Service	OEM	Service			
	(014-)	(914-)	(014-)	(914-)	(040-)	(940-)			
D ZRDU11MCE-TF*							IP	0150-00	7
D ZRDU11MC-TF*							IP	0150-00	7
D ZRDT12MC-TF*							IP	0150-00	7
D ZRDT12MCE-TF*							IP	0150-00	7
D ZRDU13MC-TF*							IP	0150-00	7
D ZRDU13MCE-TFD							IP	0150-00	7
D ZRDT14MC-TF*							IP	0150-00	7
D ZRDT14MCE-TF*							IP	0150-00	7
ZR16K4(E)-PFJ*	0061-27	0036-03	0064-07	0037-11	0166-37	0001-79	IP	0044-15	6
ZR16K4(E)-PFV*	0061-27	0036-03	0064-06	0037-10	0166-37	0001-79	IP	0044-15	6
ZR16K5(E)-PFV*	0061-27	0036-03	0064-06	0037-10	0166-37	0001-79	IP	0044-15	6
ZR16K5E-PFJ*	0061-27	0036-03	0064-06	0037-10	0166-37	0001-79	IP	0044-15	6
ZR16KC-PFV*	0061-27	0036-03	0064-06	0037-10	0166-37	0001-79	IP	0044-15	6
D ZRDT16MC-TF*							IP	0150-00	7
D ZRDT16MCE-TFD							IP	0150-00	7
D ZRDT25MC-TF5							IP	0177-00	4
ZR18K3(E)-PFV*	0061-27	0036-03	0064-06	0037-10	0166-37	0001-79	IP	0116-00	8
ZR18K4(E)-PFJ*	0061-27	0036-03	0064-13	0037-17	0166-37	0001-79	IP	0044-15	6
ZR18K4(E)-PFV*	0061-27	0036-03	0064-07	0037-11	0166-37	0001-79	IP	0044-15	6
ZR18K5(E)-PFV*	0061-27	0036-03	0064-06	0037-10	0166-37	0001-79	IP	0044-15	6
ZR18K5E-PFJ*	0061-27	0036-03	0064-06	0037-10	0166-37	0001-79	IP	0044-15	6
ZR18KC-PFV*	0061-27	0036-03	0064-06	0037-10	0166-37	0001-79	IP	0044-15	6
ZR21K5(E)-PFJ*	0061-27	0036-03	0064-07	0037-11	0166-15	0001-55	IP	0044-15	6
ZR21K5(E)-PFV*	0061-27	0036-03	0064-07	0037-11	0166-37	0001-79	IP	0044-15	6
ZR21K5(E)-TF*							IP	0044-15	6
ZR22K3(E)-PFJ*			0064-14	0037-18			IP	0116-00	7
ZR22K3(E)-PFV*	0061-27	0036-03	0064-25	0037-36	0166-37	0001-79	IP	0116-00	7
ZR22K3(E)-TF*							IP	0116-00	7
ZR22K4(E)-PFJ*	0061-27	0036-03	0064-25	0037-36	0166-37	0001-79	IP	0044-15	6
ZR22K4(E)-PFV*	0061-27	0036-03	0064-07	0037-11	0166-37	0001-79	IP	0044-15	6
ZR22KC-PFV*	0061-27	0036-03	0064-07	0037-11	0166-37	0001-79	IP	0044-15	6
ZR24K3(E)-PFJ*	0061-27	0036-03	0064-25	0037-18	0166-37	0001-79	IP	0116-00	7
ZR24K3(E)-PFV*	0061-27	0036-03	0064-08	0037-12	0166-37	0001-79	IP	0116-00	7
ZR24K3(E)-TF*							IP	0116-00	7
ZR24K4(E)-PFJ*	0061-27	0036-03	0064-25	0037-36	0166-37	0001-79	IP	0044-15	6
ZR24K4(E)-PFV*	0061-27	0036-03	0064-07	0037-11	0166-37	0001-79	IP	0044-15	6
ZR24KC-PFV*	0061-27	0036-03	0064-07	0037-11	0166-37	0001-79	IP	0044-15	6
ZR25K5(E)-PFJ*	0061-27	0036-03	0064-13	0037-17	0166-37	0001-79	IP	0044-15	6
ZR25K5(E)-PFV*	0061-27	0036-03	0064-08	0037-12	0166-37	0001-79	IP	0044-15	6
ZR25K5(E)-TF*							IP	0044-15	6
D ZRDT25MCE-TFD							IP	0177-00	
ZR26K3(E)-PFJ*			0064-25	0037-18			IP	0116-00	7
ZR26K3(E)-PFV*	0061-27	0036-03	0064-08	0037-12	0166-37	0001-79	IP	0116-00	7
ZR26K3(E)-TF*							IP	0116-00	7
ZR26K5-PFV*	0061-27	0036-03	0064-25	0037-36	0166-37	0001-79	IP	0044-15	6
ZR26KC-PFV*	0061-27	0036-03	0064-12	0037-16	0166-37	0001-79	IP	0044-15	7
ZR28K3(E)-PFJ*			0064-15	0037-19			IP	0116-00	7
ZR28K3(E)-PFV*	0061-27	0036-03	0064-25	0037-36	0166-37	0001-79	IP	0116-00	7
ZR28K3(E)-TF*							IP	0116-00	7
ZR28K5(E)-PFJ*	0061-27	0036-03	0064-25	0037-36	0166-37	0001-79	IP	0044-15	6
ZR28K5(E)-PFV*	0061-27	0036-03	0064-25	0037-36	0166-37	0001-79	IP	0044-15	6
ZR28K5(E)-TF*							IP	0044-15	6

D = Digital

ZR - Compressor Parts

Model	Start Capacitor		Run Capacitor		Relay		Motor Protector	Mounting Parts	Crankcase Heater
	OEM	Service	OEM	Service	OEM	Service			
	(014-)	(914-)	(014-)	(914-)	(040-)	(940-)		(527-)	
ZR28KC-PFV*	0061-27	0036-03	0064-13	0037-17	0166-37	0001-79	IP	0044-15	7
ZR28KC-TF*							IP	0044-15	7
ZR30K3(E)-PFJ*			0064-15	0037-19			IP	0116-00	7
ZR30K3(E)-PFV*	0061-27	0036-03	0064-25	0037-36	0166-37	0001-79	IP	0116-00	7
ZR30K3(E)-TF*							IP	0116-00	7
ZR30KC-PFV*	0061-27	0036-03	0064-07	0037-11	0166-37	0001-79	IP	0116-00	7
ZR32K3(E)-PFJ*			0064-15	0037-19			IP	0116-00	7
ZR32K3(E)-PFV*	0061-27	0036-03	0064-25	0037-36	0166-37	0001-79	IP	0116-00	7
ZR32K3(E)-TF*							IP	0116-00	7
ZR32K5(E)-PFJ*			0064-25	0037-36			IP	0044-15	6
ZR32K5(E)-PFV*	0061-27	0036-03	0064-29	0037-40	0166-37	0001-79	IP	0044-15	6
ZR32K5(E)-TF*							IP	0044-15	6
ZR32KC-PFV*	0061-27	0036-03	0064-13	0037-17	0166-37	0001-79	IP	0116-00	7
ZR34K3(E)-PFJ*			0064-16	0037-20			IP	0116-00	7
ZR34K3(E)-PFV*	0061-27	0036-03	0064-29	0037-40	0166-37	0001-79	IP	0116-00	7
ZR34K3(E)-TF*							IP	0116-00	7
ZR34K5(E)-PFV*	0061-27	0036-03	0064-26	0037-37	0166-07	0140-08	IP	0044-15	6
ZR34K5-TF*							IP	0044-15	6
ZR34KC-PFV*	0061-27	0036-03	0064-08	0037-12	0166-37	0001-79	IP	0116-00	7
ZR34KC-TF*							IP	0116-00	7
ZR35K5-TF*							IP	0044-15	6
ZR36K3(E)-PFJ*			0064-16	0037-20			IP	0116-00	7
ZR36K3(E)-PFV*	0061-27	0036-03	0064-29	0037-40	0166-37	0001-79	IP	0116-00	7
ZR36K3(E)-TF*							IP	0116-00	7
ZR36KC-PFV*	0061-27	0036-03	0064-14	0037-18	0166-37	0001-79	IP	0116-00	7
D ZRD36KCE-PF*			0064-29	0037-40			IP	0116-00	7 and 13
ZR36KC-TF*							IP	0116-00	7
D ZRD36KC-TF*							IP	0116-00	4 and 7
D ZRD36KCE-TF*							IP	0116-00	7 and 13
ZR38K5(E)-PFJ*			0064-26	0037-37			IP	0116-00	13
ZR38K5(E)-PFV*	0061-27	0036-03	0064-28	0037-39	0166-37	0001-79	IP	0116-00	13
ZR38K5(E)-TF*							IP	0116-00	13
ZR40K3(E)-PFJ*			0064-17	0037-21			IP	0116-00	7
ZR40K3(E)-PFV*	0061-27	0036-03	0064-28	0037-39	0166-37	0001-79	IP	0116-00	7
ZR40K3(E)-TF*							IP	0116-00	7
ZR40KC-PFV*	0061-27	0036-03	0064-14	0037-18	0166-37	0001-79	IP	0116-00	7
ZR40KC-TF*							IP	0116-00	7
ZR42K3(E)-PFJ*			0064-18	0037-22			IP	0116-00	7
ZR42K3(E)-PFV*	0061-27	0036-03	0064-26	0037-37	0166-37	0001-79	IP	0116-00	7
ZR42K3(E)-TF*							IP	0116-00	7
ZR42K5(E)-PFJ*			0064-18	0037-22			IP	0116-00	13
ZR42K5(E)-PFV*	0061-27	0036-03	0064-28	0037-39	0166-37	0001-79	IP	0116-00	13
ZR42K5(E)-TF*							IP	0116-00	13
ZR42KC-PFV*	0061-27	0036-03	0064-14	0037-18	0166-37	0001-79	IP	0116-00	7
D ZRD42KCE-PFJ*	0061-27	0036-03	0064-26	0037-22	0166-37	0001-79	IP	0116-00	7 and 13
ZR42KC-TF*							IP	0116-00	7
D ZRD42KCE-TF*							IP	0116-00	7 and 13
ZR44K5-PFV*	0061-27	0036-03	0064-26	0037-37	0166-37	0001-79	IP	0116-00	13
ZR44K5-TF*							IP	0116-00	13
ZR45K3(E)-PFJ*			0064-18	0037-22			IP	0116-00	7
ZR45K3(E)-PFV*	0061-27	0036-03	0064-28	0037-39	0166-37	0001-79	IP	0116-00	7
ZR45K3-TF*							IP	0116-00	7

D = Digital

ZR – Copeland Scroll™ Compressors

ZR - Compressor Parts

Model	Start Capacitor		Run Capacitor		Relay		Motor Protector	Mounting Parts (527-)	Crankcase Heater
	OEM	Service	OEM	Service	OEM	Service			
	(014-)	(914-)	(014-)	(914-)	(040-)	(940-)			
ZR45KC(E)-TF*							IP	0116-00	7
ZR45KC-PFV*	0061-27	0036-03	0064-08	0037-12	0166-37	0001-79	IP	0116-00	7
ZR46K3(E)-PFV*	0006-15	0006-10	0064-26	0037-37	0166-37	0001-79	IP	0116-00	7
ZR46K3(E)-TF*							IP	0116-00	7
ZR46KC(E)-TF*							IP	0116-00	7
ZR47K3(E)-PFJ*			0064-18	0037-22			IP	0116-00	7
ZR47K3(E)-PFV*	0061-27	0036-03	0064-18	0037-22	0166-37	0001-79	IP	0116-00	7
ZR47K3(E)-TF*							IP	0116-00	7
ZR47KC(E)-TF*							IP	0116-00	7
ZR47KC-PFV*	0061-27	0036-03	0064-25	0037-36	0166-37	0001-79	IP	0116-00	7
ZR48K3(E)-PFJ*			0064-18	0037-22			IP	0116-00	7
ZR48K3(E)-PFV*	0061-27	0036-03	0064-18	0037-22	0166-37	0001-79	IP	0116-00	7
ZR48K3(E)-TF*							IP	0116-00	7
ZR48K5(E)-PFJ*			0064-35	0037-52			IP	0116-00	13
ZR48K5(E)-PFV*	0061-27	0036-03	0064-18	0037-22	0166-37	0001-79	IP	0116-00	13
ZR48K5(E)-TF*							IP	0116-00	13
ZR48KC(E)-PFV*	0061-27	0036-03	0064-14	0037-18	0166-37	0001-79	IP	0116-00	7
D ZRD48KCE-PFV*			0064-26	0037-37			IP	0116-00	7 and 13
D ZRD48KC-TF*							IP	0116-00	7 and 13
ZR48KC(E)-TF*							IP	0116-00	7
D ZRD48KCE-TF*							IP	0116-00	7 and 13
ZR49K3(E)-PFV*	0006-15	0006-10	0064-26	0037-37	0166-37	0001-79	IP	0116-00	7
ZR49K3(E)-TF*							IP	0116-00	7
ZR49K3-PFV*	0006-15	0006-10	0064-26	0037-37	0166-37	0001-79	IP	0116-00	7
ZR49KC(E)-PFV*	0006-15	0006-10	0064-15	0037-19	0166-37	0001-79	IP	0116-00	7
D ZRD49KCE-PFV*	0006-15		0064-26	0037-37	0166-37	0001-79	IP	0116-00	7
ZR49KC(E)-TF*							IP	0116-00	7
D ZRD49KCE-TF*							IP	0116-00	7
ZR51KC-TF*							IP	0116-00	7
ZR52K3-PFV*	0006-15	0006-10	0064-27	0037-38	0166-37	0001-79	IP	0116-00	7
ZR52K3-TF*							IP	0116-00	7
ZR54K3(E)-PFV*	0006-15	0006-10	0064-27	0037-38	0166-37	0001-79	IP	0116-00	7
ZR54K3(E)-TF*							IP	0116-00	7
ZR54K3-PFV*	0006-15	0006-10	0064-27	0037-38	0166-37	0001-79	IP	0116-00	7
ZR54K5(E)-PFV*	0061-27	0036-03	0064-27	0037-38	0166-37	0001-79	IP	0116-00	13
ZR54K5(E)-TF*							IP	0116-00	13
ZR54KC(E)-TF*							IP	0116-00	7
ZR54KC-PFV*	0006-15	0006-10	0064-26	0037-37	0166-37	0001-79	IP	0116-00	
ZR57K3(E)-PFV*	0006-15	0006-10	0064-27	0037-38	0166-37	0001-79	IP	0116-00	7
ZR57K3(E)-TF*							IP	0116-00	7
ZR57K3-PFV*	0006-15	0006-10	0064-27	0037-38	0166-37	0001-79	IP	0116-00	7
ZR57KC(E)-TF*							IP	0116-00	7
ZR57KC-PFV*	0006-15	0006-10	0064-26	0037-37	0166-37	0001-79	IP	0116-00	7
ZR61K3(E)-PFV*	0006-15	0006-10	0064-27	0037-38	0166-37	0001-79	IP	0116-00	7
D ZRD61KCE-PFV*	0006-15	0006-10	0064-27	0037-38	0166-37	0001-79	IP	0116-00	7
ZR61K3(E)-TF*							IP	0116-00	7
ZR61KC(E)-PFV*	0006-15	0006-10	0064-34	0037-51	0166-37	0001-79	IP	0116-00	7
ZR61KC(E)-TF*							IP	0116-00	7
D ZRD61KCE-TF*							IP	0116-00	7
ZR67KC-PFV*	0006-15	0006-10	0064-26	0037-37	0166-37	0001-79	IP	0116-00	7
ZR67KW(E)-PFV*	0006-15	0006-10	0064-26	0037-37	0166-37	0001-79	IP	0116-00	7
ZR68KC(E)-PFJ*			0064-16	0037-20			IP	0116-00	7

D = Digital

ZR - Compressor Parts

Model	Start Capacitor		Run Capacitor		Relay		Motor Protector	Mounting Parts	Crankcase Heater
	OEM	Service	OEM	Service	OEM	Service			
	(014-)	(914-)	(014-)	(914-)	(040-)	(940-)		(527-)	
ZR68KC(E)-PFV*	0006-15	0006-10	0064-35	0037-52	0166-37	0001-79	IP	0116-00	7
ZR68KC(E)-TF*							IP	0116-00	7
ZR72KC(E)-TF*							IP	0116-00	7
D ZRD72KCE-TF*							IP	0116-00	7
ZR80KC-PFV*	0006-15	0006-10	0064-35	0037-52	0166-37	0001-79	IP	0116-00	7
ZR80KW-PFV*	0006-15	0006-10	0064-35	0037-52	0166-37	0001-79	IP	0116-00	7
ZR81KC(E)-TF*							IP	0116-00	7
ZR84KC(E)-TF*							IP	0116-00	4
ZR90K3(E)-TW*							NOTE 2D	0159-00	9
ZR94KC(E)-TF*							IP	0116-00	4
D ZRD94KCE-TF*							IP	0116-00	
D ZRDT96KC-TF*							IP	0150-00	7 and 13
ZR108KC(E)-TF*							IP	0116-00	4
ZR11M3(E)-TW*							NOTE 2D	0159-00	9
ZR12M3(E)-TW*							NOTE 2D	0159-00	9
ZR125KC(E)-TF*							IP	0116-00	4
D ZRD125KCE-TF*							IP	0116-00	4 and 7
ZR144KC(E)-TF*							IP	0116-00	4
ZR160KC(E)-TE*							NOTE 3	0210-00	4
ZR160KC(E)-TW*							NOTE 2A	0210-00	4
ZR16M3(E)-TW*							NOTE 2D	0159-00	9
ZR190KC(E)-TE*							NOTE 3	0210-00	4
ZR190KC(E)-TW*							NOTE 2A	0210-00	4
ZR19M3(E)-TW*							NOTE 2D	0159-00	9
ZR250KC(E)-TE*							NOTE 3	0175-02	5A
ZR250KC(E)-TW*							NOTE 2D	0175-02	5A
ZR300KC(E)-TE*							NOTE 3	0175-00	5B
ZR300KC(E)-TW*							NOTE 2D	0175-00	5B
ZR310KC(E)-TE*							NOTE 3	0175-00	5B
ZR310KC(E)-TW*							NOTE 2D	0175-02	5B
ZR380KC(E)-TE*							NOTE 3	0175-00	5B
ZR380KC(E)-TW*							NOTE 2D	0175-02	5B

D = Digital

Advanced Scroll Temperature Protection (ASTP), a feature to guard scroll compressors from overheating.

ASTP MODELS		
ZB50	-	ZR84
ZB58	ZP90	ZR94
ZB66	ZP103	ZR108
ZB76	ZP120	ZR125
ZB88	ZP137	ZR144
ZB95	ZP154	ZR160
ZB114	ZP182	ZR190

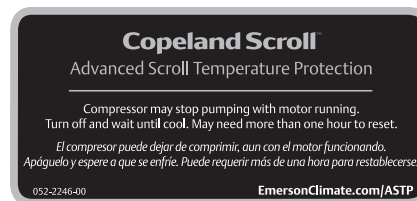

ZR – Copeland Scroll™ Compressors

ZRS - Compressor Parts

Model	Start Capacitor		Run Capacitor		Relay		Motor Protector	Mounting Parts	Crankcase Heater
	OEM	Service	OEM	Service	OEM	Service			
	(014-)	(914-)	(014-)	(914-)	(040-)	(940-)		(527-)	
ZRS35K4(E)-PFV*	0061-27	0036-03	0064-08	0037-12	0166-21	0001-62	IP	0116-00	7
ZRS43K4(E)-PFV*	0061-27	0036-03	0064-25	0037-36	0166-37	0001-79	IP	0116-00	7
ZRS43K4(E)-TF*							IP	0116-00	7
ZRS52K4(E)-PFV*	0006-17	0006-12	0064-27	0037-38	0166-07	0140-08	IP	0116-00	7
ZRS52K4(E)-TF*							IP	0116-00	7

ZRU - Uneven Tandems

Model	Motor Protector	Mounting Parts	Crankcase Heater	Model	Motor Protector	Mounting Parts	Crankcase Heater
		(527-)				(527-)	
ZRU140KCE-TFD	IP	0181-00	7	ZRU350KC-TEE	EP	0177-00	4
ZRU140KCE-TF5	IP	0181-00	7	ZRU350KC-TE5	EP	0177-00	4
ZRU178KCE-TFD	IP	0177-00	4	ZRU350KC-TE7	EP	0177-00	4
ZRU178KCE-TFE	IP	0177-00	4	ZRU350KCE-TED	EP	0177-00	4
ZRU178KCE-TF5	IP	0177-00	4	ZRU350KCE-TEE	EP	0177-00	4
ZRU178KCE-TF7	IP	0177-00	4	ZRU350KCE-TE5	EP	0177-00	4
ZRU350KC-TED	EP	0177-00	4	ZRU350KCE-TE7	EP	0177-00	4



ZRT - Compressor Parts

Model	Mounting Parts		For Crankcase Heaters and Start Components, see Compressor
	Compressor to Rails	Rails to Mounting Surface	
ZRT90K3(E)-PFV*	527-0212-00	527-0150-00	ZR45K3(E)
ZRT90K3-TF*	527-0212-00	527-0150-00	ZR45K3
ZRT90KC-PFV*	527-0212-00	527-0150-00	ZR45KC
ZRT90KC-TF*	527-0212-00	527-0150-00	ZR45KC
ZRT92K3-PFV*	527-0212-00	527-0150-00	ZR46K3
ZRT92K3-TF*	527-0212-00	527-0150-00	ZR46K3
ZRT96K3(E)-PFV*	527-0212-00	527-0150-00	ZR48K3(E)
ZRT96K3(E)-TF*	527-0212-00	527-0150-00	ZR48K3(E)
ZRT96KC(E)-PFV*	527-0212-00	527-0150-00	ZR48KC(E)
ZRT96KC(E)-TF*	527-0212-00	527-0150-00	ZR48KC(E)
ZRT98K3(E)-TF*	527-0212-00	527-0150-00	ZR49K3(E)
ZRT98K3-PFV*	527-0212-00	527-0150-00	ZR49K3
ZRT108K3(E)-TF*	527-0212-00	527-0150-00	ZR54K3(E)
ZRT108K3-PFV*	527-0212-00	527-0150-00	ZR54K3
ZRT108KC-TF*	527-0212-00	527-0150-00	ZR54KC
ZRT114K3-TF*	527-0212-00	527-0150-00	ZR57K3
ZRT114K3-PFV*	527-0212-00	527-0150-00	ZR57K3
ZRT122K3(E)-PFV*	527-0212-00	527-0150-00	ZR61K3(E)
ZRT122K3(E)-TF*	527-0212-00	527-0150-00	ZR61K3(E)
ZRT122KC(E)-TF*	527-0212-00	527-0150-00	ZR61KC(E)
ZRT136KC(E)-TF*	527-0181-00	527-0150-00	ZR68KC(E)
ZRT144KC(E)-TF*	527-0181-00	527-0150-00	ZR72KC(E)
ZRT162KC(E)-TF*	527-0181-00	527-0150-00	ZR81KC(E)
ZRT168KC(E)-TF*	027-0385-00	527-0177-00	ZR84KC(E)
ZRT180K3(E)-TW*	527-0166-00	527-0177-00	ZR90K3(E)
ZRT188KC(E)-TF*	027-0385-00	527-0177-00	ZR94KC(E)
ZRT216KC(E)-TF*	027-0385-00	527-0177-00	ZR108KC(E)
ZRT220K3(E)-TW*	527-0166-00	527-0177-00	ZR11M3(E)
ZRT240K3(E)-TW*	527-0166-00	527-0177-00	ZR12M3(E)
ZRT250KC(E)-TF*	027-0385-00	527-0177-00	ZR125KC(E)
ZRT288KC(E)-TF*	027-0385-00	527-0177-00	ZR144KC(E)
ZRT320K3(E)-TW*	527-0166-00	527-0177-00	ZR160K3(E)
ZRT320KC(E)-TE*	027-0385-00	527-0177-00	ZR160KC(E)
ZRT320KC(E)-TW*	027-0385-00	527-0177-00	ZR160KC(E)
ZRT380K3(E)-TW*	527-0166-00	527-0177-00	ZR19M3(E)
ZRT380KC(E)-TE*	027-0385-00	527-0177-00	ZR190KC(E)
ZRT380KC(E)-TW*	027-0385-00	527-0177-00	ZR190KC(E)
ZRT500KC(E)-TE*	527-0178-00	N/A	ZR250KC(E)
ZRT500KC(E)-TW*	527-0178-00	N/A	ZR250KC(E)
ZRT600KC(E)-TE*	527-0178-00	N/A	ZR300KC(E)
ZRT600KC(E)-TW*	527-0178-00	N/A	ZR300KC(E)
ZRT760KC(E)-TE*	527-0178-00	N/A	ZR380KC(E)
ZRT760KC(E)-TW	527-0178-00	N/A	ZR380KC(E)

ZS – Copeland Scroll™ Compressors

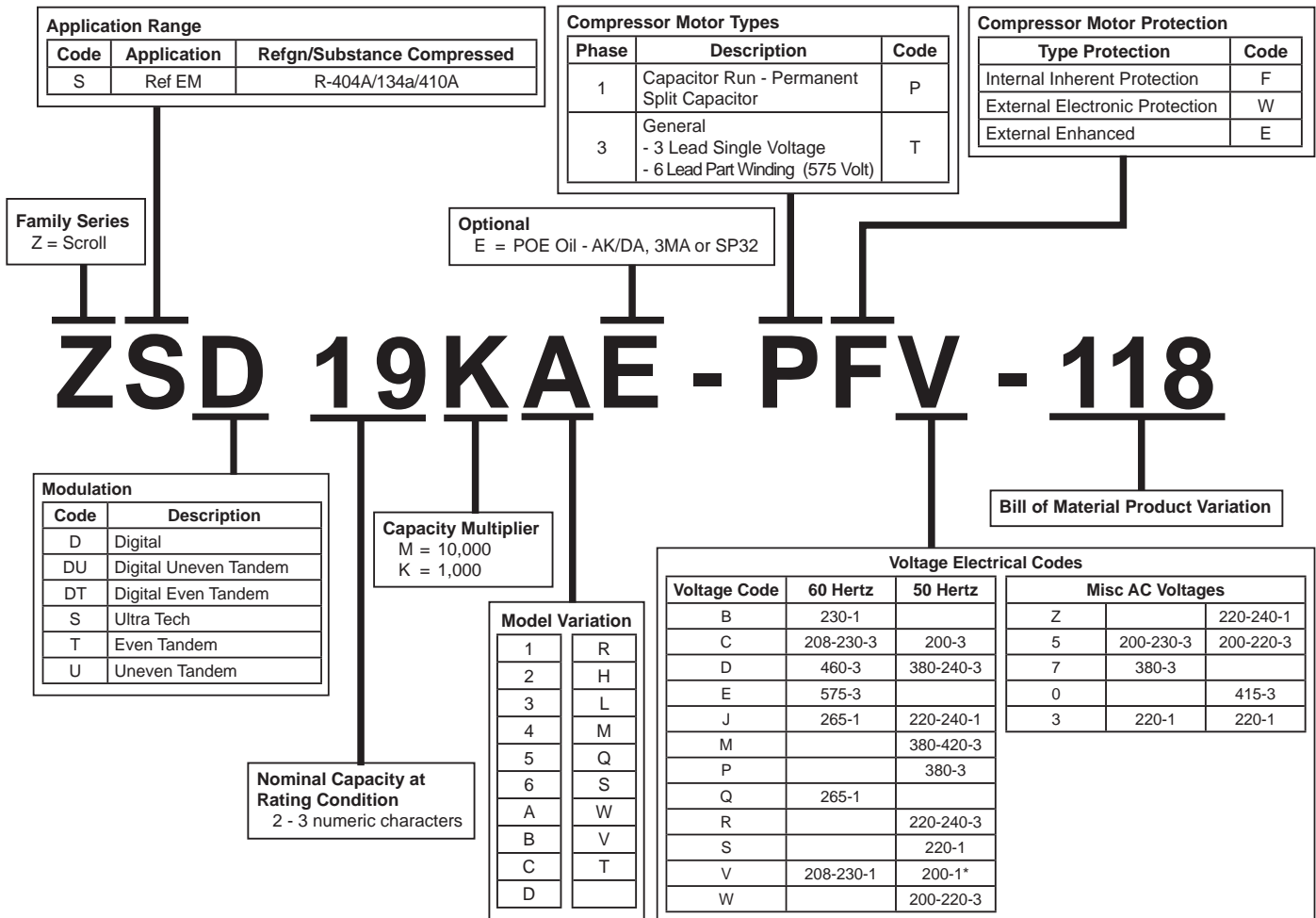

Common Replacement Parts

Molded Plug	Part Number
10 GA. - All K4/K4E and K5/K5E 130 or 830 BOM compressors	529-0060-04
Oil Controls and Adapters	Part Number
OMB Oil Control - All Models	065365
OMB Adapter	Sight Glass Connection-Part#
ZS15K4E-ZS92K4E, ZS11MCE	Int. Thread (3/4" NPTF)-065668
ZS15K4E-ZS45K4E	Ext. Thread (1 1/4" -12 UNF)-066650
ZS56/75/92KCE, ZS11MCE	Ext. Thread (1 3/4" -12 UNF)-066078
Discharge Line Thermostat	Part Number
1/2" Discharge Line Thermostat	998-7022-02
5/8" Discharge Line Thermostat	998-7022-04
7/8" Discharge Line Thermostat	998-7022-05



ZS Motor Protector Modules

Note #	OEM	Service	Voltage
2A	071-0660-00	971-0641-00	24V
2A	071-0660-01	971-0641-01	120/240V
2B	071-0650-00	971-0547-01	120/240V

ZS Crankcase Heater Notes

Note #	OEM	Service	Volts	Watts	Lead Length
6	018-0094-01	918-0052-01	120 V	40 WATT	21" LEAD
6	018-0094-00	918-0052-00	240 V	40 WATT	21" LEAD
7	018-0095-00		240 V	70 WATT	29" LEAD
7	018-0095-01		480 V	70 WATT	29" LEAD
7	018-0095-02		575 V	70 WATT	29" LEAD
7	018-0095-07	918-0043-07	120 V	70 WATT	48" LEAD
7	018-0095-04	918-0043-00	240 V	70 WATT	48" LEAD
7	018-0095-05	918-0043-01	480 V	70 WATT	48" LEAD
7	018-0095-06	918-0043-02	575 V	70 WATT	48" LEAD
9	018-0091-17	918-0019-01	120 V	70 WATT	30" LEAD
9	018-0091-18	918-0019-04	240 V	70 WATT	30" LEAD
9	018-0091-19	918-0019-08	460 V	70 WATT	30" LEAD
9	018-0091-15	918-0019-09	575 V	60 WATT	30" LEAD



ZS – Copeland Scroll™ Compressors

ZS - Compressor Parts

Model	Start Capacitor		Run Capacitor		Relay		Motor Protec- tor	Mounting Parts (527-)	Hard Mount Kit (527-)	CH *	Molded Plug (529-)	Sight- glass Kit (998-)
	OEM	Service	OEM	Service	OEM	Service						
	(014-)	(914-)	(014-)	(914-)	(040-)	(940-)						
ZS09KAE-PFV	0061-27	0036-03	0064-06	0037-10	0166-37	0001-79	IP	0044-15		6	0060-24	
ZS09KAE-TF*							IP	0044-15		6	0060-24	
ZS11KAE-PFV	0061-27	0036-03	0064-06	0037-10	0166-37	0001-79	IP	0044-15		6	0060-24	
ZS11KAE-TF*							IP	0044-15		6	0060-24	
ZS13KAE-PFV	0061-27	0036-03	0064-07	0037-11	0166-37	0001-79	IP	0044-15		6	0060-24	
ZS13KAE-TF*							IP	0044-15		6	0060-24	
ZS15K4(E)-PFV	0061-27	0036-03	0064-08	0037-12	0166-37	0001-79	IP	0116-00	0157-00	7		0010-02
ZS15K4(E)-TF*							IP	0116-00	0157-00	7		0010-02
ZS15KAE-PFV	0061-27	0036-03	0064-08	0037-12	0166-37	0001-79	IP	0044-15		6	0060-24	
ZS15KAE-TF*							IP	0044-15		6	0060-24	
ZS19K4(E)-PFV	0061-27	0036-03	0064-25	0037-36	0166-37	0001-79	IP	0116-00	0157-00	7		0010-02
ZS19K4(E)-TF*							IP	0116-00	0157-00	7		0010-02
ZS19KAE-PFV	0061-27	0036-03	0064-25	0037-36	0166-37	0001-79	IP	0044-15		6	0060-24	
ZS19KAE-TF*							IP	0044-15		6	0060-24	
ZS21K4(E)-PFV	0061-27	0036-03	0064-29	0037-40	0166-37	0001-79	IP	0116-00	0157-00	7		0010-02
ZS21K4(E)-TF*							IP	0116-00	0157-00	7		0010-02
ZS21KAE-PFV	0061-27	0036-03	0064-28	0037-39	0166-37	0001-79	IP	0116-00		7	0060-24	
ZS21KAE-TF*							IP	0116-00		7	0060-24	
ZS26K4(E)-PFV	0061-27	0036-03	0064-26	0037-37	0166-37	0001-79	IP	0116-00	0157-00	7		0010-02
ZS26K4(E)-TF*							IP	0116-00	0157-00	7		0010-02
ZS26KAE-PFV	0061-27	0036-03	0064-28	0037-39	0166-37	0001-79	IP	0116-00		7	0060-24	
ZS26KAE-TF*							IP	0116-00		7	0060-24	
ZS29KAE-PFV	0061-27	0036-03	0064-18	0037-22	0166-37	0001-79	IP	0116-00		7	0060-24	
ZS29KAE-TF*							IP	0116-00		7	0060-24	
ZS30K4(E)-PFV	0061-27	0036-03	0064-26	0037-37	0166-37	0001-79	IP	0116-00	0157-00	7		0010-02
ZS30K4(E)-TF*							IP	0116-00	0157-00	7		0010-02
ZS33KAE-PFV	0061-27	0036-03	0064-27	0037-38	0166-37	0001-79	IP	0116-00		7	0060-24	
ZS33KAE-TF*							IP	0116-00		7	0060-24	
ZS38K4(E)-TF*							IP	0116-00	0157-00	7		0010-02
ZS38K4E-PFV	0006-15	0006-10	0064-27	0037-38	0166-37	0001-79	IP	0116-00	0157-00	7		0010-02
ZS45K4(E)-TF*							IP	0116-00	0157-00	7		0010-02
ZS56K4(E)-TW*							NOTE 2B	0159-00	0158-00	9		0010-02
ZS75K4(E)-TW*							NOTE 2B	0159-00	0158-00	9		0010-02
ZS75KA-TW*							NOTE 2B	0159-00	0158-00	9		0010-02
ZS92K4(E)-TW*							NOTE 2B	0159-00	0158-00	9		0010-02
ZS92K5E-TW*							NOTE 2B	0159-00	0158-00	9		0010-02
ZS11M4(E)-TW*							NOTE 2B	0159-00	0158-00	9		0010-02

Copeland Semi-Hermetic Mounting Parts and Kits

Compressor Model	Kit Number (527)	Mounting Stud		Spring (Motor End)			Spring (Compressor End)			Rubber Spacer		Shipping Retainer	
		Part Number	QTY	Part # (006)	QTY	Color	Part # (006)	QTY	Color	Part # (027)	QTY	Part # (074)	QTY
EA/ER	0006-00	100-0012-45	4	0012-00	2	Grey	0012-00	2	Grey	0192-00	4	0619-00	4
H	0005-01	103-0001-03 *	4	0013-01	2	Dark Blue	0013-01	2	Dark Blue	0015-00	4		
K 1/2 to 1 HP	0005-02	103-0001-03 *	4	0013-01	2	Dark Blue	0013-02	2	Dark Maroon	0015-00	4		
K 1-1/2 & 2 HP	0005-03	103-0001-03 *	4	0013-02	2	Dark Maroon	0013-02	2	Dark Maroon	0015-00	4		
LA	0007-00	100-0012-45	4	0012-01	2	Dark Blue	0012-01	2	Dark Blue	0192-00	4	0619-00	4
MR	0105-00	100-0012-46	4	0012-02	2	Maroon	0012-02	2	Maroon	0192-00	4	0619-01	4
NR 3 HP	0007-00	100-0012-45	4	0012-01	2	Dark Blue	0012-01	2	Dark Blue	0192-00	4	0619-00	4
NR 4 to 5 HP	0040-00	100-0012-45	4	0103-00	2	Orange	0103-00	2	Orange	0192-00	4	0619-00	4
2D	0105-00	100-0012-46	4	0012-02	2	Maroon	0012-02	2	Maroon	0192-00	4	0619-01	4
3A/3R	0007-00	100-0012-45	4	0012-01	2	Dark Blue	0012-01	2	Dark Blue	0192-00	4	0619-00	4
3D 5 to 6 HP	0009-00	100-0012-43	4	0012-02	2	Maroon	0012-02	2	Maroon	0192-00	4	0619-01	4
3DA 7-1/2 HP	0009-00	100-0012-43	4	0012-02	2	Maroon	0012-02	2	Maroon	0192-00	4	0619-01	4
3DB 10 HP	0045-00	100-0012-43	4	0012-02	2	Maroon	0110-00	2	White	0192-00	4	0619-01	4
3DB 7-1/2 HP	0009-00	100-0012-43	4	0012-02	2	Maroon	0012-02	2	Maroon	0192-00	4	0619-01	4
3DF/3DS 7-1/2 to 10 HP	0045-00	100-0012-43	4	0012-02	2	Maroon	0110-00	2	White	0192-00	4	0619-01	4
4D/4R 10 to 22 HP	0037-00	100-0012-43	4	0087-00	2	Yellow	0086-00	2	Green	0192-00	4	0619-01	4
6R 10 HP	0037-00	100-0012-43	4	0087-00	2	Yellow	0086-00	2	Green	0192-00	4	0619-01	4
FLAT BOTTOM													
3D 15 HP	0081-00	100-0012-43	4	0087-00	2	Yellow	0211-00	2	Red	0192-00	4	0619-01	4
4D/4R 25 to 30 HP	0042-00	100-0012-43	4	0108-00	2	Black	0086-00	2	Green	0192-00	4	0619-01	4
6D/6R 20 to 30 HP	0042-00	100-0012-43	4	0108-00	2	Black	0086-00	2	Green	0192-00	4	0619-01	4
6D/6R 35 HP	0057-00	100-0012-43	4	0149-00	2	Blue	0086-00	2	Green	0192-00	4	0619-01	4
DEEP SUMP **													
4DA/4DH	0081-00	100-0012-43	4	0087-00	2	Yellow	0211-00	2	Red	0192-00	4	0619-01	4
4DJ 20 & 30 HP	0079-00	100-0012-43	4	0108-00	2	Black	0211-00	2	Red	0192-00	4	0619-01	4
4RA, 4RH, 4RE, & 4RK	0081-00	100-0012-43	4	0087-00	2	Yellow	0211-00	2	Red	0192-00	4	0619-01	4
4RJ 20 & 30 HP	0079-00	100-0012-43	4	0108-00	2	Black	0211-00	2	Red	0192-00	4	0619-01	4
6D 40 HP	0080-00	100-0012-43	4	0149-00	2	Blue	0211-00	2	Red	0192-00	4	0619-01	4
6DH, 6RA, & 6RH	0081-00	100-0012-43	4	0087-00	2	Yellow	0211-00	2	Red	0192-00	4	0619-01	4
6DT 30 HP	0080-00	100-0012-43	4	0149-00	2	Blue	0211-00	2	Red	0192-00	4	0619-01	4
8D	0115-00	100-0012-49	4	0284-00	2	Purple	0283-00	2	Brown	0192-00	4	0619-04	4

* Rubber Space (Lower) 027-0014-00 QTY 4

** Deep Sump - Only commonly used models are listed

Quick Reference Guide

Copeland Reed Compressor Service Valves

Comp. Model	Discharge Valves					Suction Valves				
	Dischg. Size (ODF)	Discharge Valve Kit (Valve, Cap, Gasket)	Valve Type	Cap (Metal)	Gasket Valve to Body	Suction Size (ODF)	Suction Valve Kit (Valve, Cap, Gasket)	Valve Type	Cap (Metal)	Gasket Valve to Body
EA 2HP/3HP	1/2	998-0510-34	2 Bolt	505-0431-00	020-1224-01	7/8	998-0510-12	2 Bolt	505-0374-00	020-1224-00
ER 2 HP	5/8	998-0510-33	2 Bolt	505-0431-00	020-1224-01	7/8	998-0510-12	2 Bolt	505-0374-00	020-1224-00
ER 3 HP	5/8	998-0510-33	2 Bolt	505-0431-00	020-1224-01	1-1/8	998-0510-13	2 Bolt	505-0374-00	020-1224-00
H 1/2 HP	3/8	998-0510-36	2 Bolt	505-0431-00	020-1224-01	1/2	998-0510-32	2 Bolt	505-0431-00	020-1224-01
K 3/4 HP	3/8	998-0510-36	2 Bolt	505-0431-00	020-1224-01	5/8	998-0510-31	2 Bolt	505-0431-00	020-1224-01
K 11/2 HP	1/2	998-0510-34	2 Bolt	505-0431-00	020-1224-01	7/8	998-0510-12	2 Bolt	505-0374-00	020-1224-00
KAGB 1 HP	3/8	998-0510-36	2 Bolt	505-0431-00	020-1224-01	5/8	998-0510-31	2 Bolt	505-0431-00	020-1224-01
KAJ/M 1 HP	1/2	998-0510-34	2 Bolt	505-0431-00	020-1224-01	5/8	998-0510-31	2 Bolt	505-0431-00	020-1224-01
KAK 2 HP	1/2	998-0510-34	2 Bolt	505-0431-00	020-1224-01	7/8	998-0510-12	2 Bolt	505-0374-00	020-1224-00
KAL 11/2HP	1/2	998-0510-34	2 Bolt	505-0431-00	020-1224-01	7/8	998-0510-12	2 Bolt	505-0374-00	020-1224-00
KAN 1/2 HP	3/8	998-0510-36	2 Bolt	505-0431-00	020-1224-01	1/2	998-0510-32	2 Bolt	505-0431-00	020-1224-01
KAR	1/2	998-0510-34	2 Bolt	505-0431-00	020-1224-01	5/8	998-0510-31	2 Bolt	505-0431-00	020-1224-01
LA/3A/3R	5/8	998-0510-33	2 Bolt	505-0431-00	020-1224-01	1-1/8	998-0510-13	2 Bolt	505-0374-00	020-1224-00
NR	5/8	998-0510-06	2 Bolt	005-0601-00	020-1224-00	1-1/8	998-0510-13	2 Bolt	505-0374-00	020-1224-00
MR	7/8	998-0510-12	2 Bolt	505-0374-00	020-1224-00	1-3/8	998-0510-11	*2 Bolt	505-0374-00	020-0489-00

* Adaptor Fitting and Gasket Kit # 998-0036-14 goes with 998-0510-11

Discharge Rotalock Adapter Kit for 2D

Kit # 998-0036-02 Can be used with Valve Models

998-0510-38	3/4"	2D
998-0510-90	7/8"	2D
998-0510-51	1-1/8"	2D

Discharge Rotalock Adapter Kit for 3D, 4D, 4R, 6D, 6R, 9R

Kit # 998-0036-00 can be used with valve models

998-0510-02	1-1/8 "	3D, 9R
998-0510-46	1-3/8"	4D, 4R, 6D, 6R
998-0510-66	1-5/8"	4D, 4R, 6D, 6R



Copeland Discus Compressor Service Discharge Valves

Comp. Model	Dischg. Size (ODF)	Discharge Valve Kit (Valve, Cap, Gasket)	Valve Type	Discharge Valve Cap	Rotalock Fitting Teflon Seal	Gasket Flange Body	Metal Cap	Mueller Valve Cap	Mueller Adaptor Fitting and Gasket Kit
2D	7/8	998-0510-12	2 Bolt	505-0280-00	--	020-1224-00	505-0374-00	--	--
3D	7/8	998-0510-37	Rotalock	505-0438-00	020-0028-03	020-0489-00	505-0438-00	--	--
3D	1-1/8	998-0510-02	Rotalock	505-0438-00	020-0028-03	020-0489-00	505-0438-00	--	--
4DA/E3-10 HP	1-1/8	998-0510-09	2 Bolt	505-0280-00	--	020-0489-00	505-0374-00	--	998-0036-13
4DA/E3-20 HP	1-3/8	998-0510-11	2 Bolt	505-0280-00	--	020-0489-00	--	505-0280-00	998-0036-14
4DH/K3-25 HP	1-3/8	998-0510-11	2 Bolt	505-0280-00	--	020-0489-00	--	505-0280-00	998-0036-14
4DJ/R3-30 HP	1-3/8	998-0510-11	2 Bolt	505-0280-00	--	020-0489-00	--	505-0280-00	998-0036-14
4DL/P3-15 HP	1-3/8	998-0510-46	Rotalock	505-0438-00	020-0028-03	020-0489-00	505-0438-00	--	--
4DT/S3-22HP	1-3/8	998-0510-46	Rotalock	505-0438-00	020-0028-03	020-0489-00	505-0438-00	--	--
6DG/M/N3-35 HP	1-5/8	998-0510-66	Rotalock	505-0435-00	020-0028-03	020-0489-00	--	--	--
6DH/K/P3-35 HP	1-5/8	998-0510-66	Rotalock	505-0435-00	020-0028-03	020-0489-00	--	--	--
6DJ/R/S3-40 HP	1-5/8	998-0510-66	Rotalock	505-0435-00	020-0028-03	020-0489-00	--	--	--
6DL/C/D3-27 HP	1-3/8	998-0510-46	Rotalock	505-0438-00	020-0028-03	020-0489-00	505-0438-00	--	--
6DT/E/F3-30 HP	1-3/8	998-0510-46	Rotalock	505-0438-00	020-0028-03	020-0489-00	505-0438-00	--	--



Copeland Discus Compressor Service Suction Valves

Comp. Model	Suction Size (ODF)	Suction Valve Kit (Valve, Cap, Gasket)	Valve Type	Gasket Valve to Body	Mueller Valve Cap	Mueller Adaptor Fitting and Gasket Kit	Hans Nobis Valve Cap	Hans Nobis Adaptor Fitting and Gasket Kit
2D	13/8	998-0510-11	2 Bolt	020-0489-00	505-0280-00	998-0036-14	--	--
3D	13/8	998-0510-11	2 Bolt	020-0489-00	505-0280-00	998-0036-14	--	--
3D	15/8	998-0510-07	4 Bolt	020-0006-46	005-0663-00	998-0036-10	005-0955-00	998-0036-20
4DA/E3-10 HP	15/8	998-0510-07	4 Bolt	020-0006-46	005-0663-00	998-0036-10	005-0955-00	998-0036-20
4DA/E3-20 HP	15/8	998-0510-07	4 Bolt	020-0006-46	005-0663-00	998-0036-10	005-0955-00	998-0036-20
4DH/K3-25 HP	21/8	998-0510-20	4 Bolt	020-0006-47	005-0664-00	998-0036-05	005-0956-00	998-0036-23
4DJ/R3-30 HP	21/8	998-0510-20	4 Bolt	020-0006-47	005-0664-00	998-0036-05	005-0956-00	998-0036-23
4DL/P3-15 HP	15/8	998-0510-07	4 Bolt	020-0006-46	005-0663-00	998-0036-10	005-0955-00	998-0036-20
4DT/S3-22HP	21/8	998-0510-20	4 Bolt	020-0006-47	005-0664-00	998-0036-05	005-0956-00	998-0036-23
6DG/M/N3-35 HP	21/8	998-0510-20	4 Bolt	020-0006-47	005-0664-00	998-0036-05	005-0956-00	998-0036-23
6DH/K/P3-35 HP	21/8	998-0510-20	4 Bolt	020-0006-47	005-0664-00	998-0036-05	005-0956-00	998-0036-23
6DJ/R/S3-40 HP	21/8	998-0510-20	4 Bolt	020-0006-47	005-0664-00	998-0036-05	005-0956-00	998-0036-23
6DL/C/D3-27 HP	21/8	998-0510-20	4 Bolt	020-0006-47	005-0664-00	998-0036-05	005-0956-00	998-0036-23
6DT/E/F3-30 HP	21/8	998-0510-20	4 Bolt	020-0006-47	005-0664-00	998-0036-05	005-0956-00	998-0036-23



A-model Sweat Connection Sizes

Model	Suction Connection Size	Discharge Connection Size	Model	Suction Connection Size	Discharge Connection Size
AF07C1*	5/16" ODF	1/4" ODF	ARE27C3*	5/16" ODF	1/4" ODF
AF22C1*	3/8" ODF	1/4" ODF	ARE29C4*	5/16" ODF	1/4" ODF
AFB04C3*	5/16" ODF	1/4" ODF	ARE34C4*	5/16" ODF	1/4" ODF
AFB05C3*	5/16" ODF	1/4" ODF	ARE35C3*	5/16" ODF	1/4" ODF
AFB06C3*	5/16" ODF	1/4" ODF	ARE36C3*	5/16" ODF	1/4" ODF
AFB09C3*	5/16" ODF	1/4" ODF	ARE37C3*	5/16" ODF	1/4" ODF
AFE05C4*	5/16" ODF	1/4" ODF	ARE40C4*	5/16" ODF	1/4" ODF
AFE06C4*	5/16" ODF	1/4" ODF	ARE41C3*	5/16" ODF	1/4" ODF
AFE07C3*	5/16" ODF	1/4" ODF	ARE46C4*	5/16" ODF	1/4" ODF
AFE08C4*	5/16" ODF	1/4" ODF	ARE47C3*	5/16" ODF	1/4" ODF
AFE10C3*	5/16" ODF	1/4" ODF	ARE51C4*	5/16" ODF	1/4" ODF
AFE11C3*	5/16" ODF	1/4" ODF	ARE59C3*	5/16" ODF	1/4" ODF
AFE11C4*	5/16" ODF	1/4" ODF	ARJ11K1*	3/8" ODF	5/16" ODF
AFE12C3*	5/16" ODF	1/4" ODF	ARJ11K2*	ROTALOCK	5/16" ODF
AFE12C4*	5/16" ODF	1/4" ODF	ARJ13K1*	3/8" ODF	5/16" ODF
AFE13C3*	5/16" ODF	1/4" ODF	ARJ84C2*	ROTALOCK	5/16" ODF
AFE13C4*	5/16" ODF	1/4" ODF	ART51C1*	3/8" ODF	1/4" ODF
AFE17C4*	5/16" ODF	1/4" ODF	ART62C1*	3/8" ODF	1/4" ODF
AFJ23C1*	ROTALOCK	5/16" ODF	ART64C1*	3/8" ODF	1/4" ODF
AFJ23C2*	ROTALOCK	5/16" ODF	ART69C1*	3/8" ODF	1/4" ODF
AFJ31C1*	ROTALOCK	5/16" ODF	ART82C1*	3/8" ODF	1/4" ODF
AFJ37C1*	ROTALOCK	5/16" ODF	ART97C1*	3/8" ODF	1/4" ODF
AFJ37C2*	ROTALOCK	1/4" ODF	ASB12C3*	5/16" ODF	1/4" ODF
AFT12C1*	3/8" ODF	1/4" ODF	ASB14C3*	5/16" ODF	1/4" ODF
AFT18C1*	3/8" ODF	1/4" ODF	ASE12C4*	5/16" ODF	1/4" ODF
AFT22C1*	3/8" ODF	1/4" ODF	ASE14C4*	5/16" ODF	1/4" ODF
AFT26C1*	3/8" ODF	1/4" ODF	ASE19C3*	5/16" ODF	1/4" ODF
AFT29C1*	3/8" ODF	1/4" ODF	ASE19C4*	5/16" ODF	1/4" ODF
ARB10C3*	5/16" ODF	1/4" ODF	ASE20C4*	5/16" ODF	1/4" ODF
ARB13C3*	5/16" ODF	1/4" ODF	ASE24C3*	5/16" ODF	1/4" ODF
ARB17C3*	5/16" ODF	1/4" ODF	ASE26C4*	5/16" ODF	1/4" ODF
ARB21C3*	5/16" ODF	1/4" ODF	ASE32C3*	5/16" ODF	1/4" ODF
ARE13C4*	5/16" ODF	1/4" ODF	ASE35C4*	5/16" ODF	1/4" ODF
ARE17C4*	5/16" ODF	1/4" ODF	AST40C1*	3/8" ODF	1/4" ODF
ARE25C3*	5/16" ODF	1/4" ODF	AST45C1*	3/8" ODF	1/4" ODF
ARE25C4*	5/16" ODF	1/4" ODF	AST54C1*	3/8" ODF	1/4" ODF

Standard connection sizes are shown above. The connection sizes may vary on special OEM Bill of Materials.

Quick Reference Guide

C-model Sweat Connection Sizes

Model	Suction Connection Size	Discharge Connection Size	Model	Suction Connection Size	Discharge Connection Size
CF04K6*	3/4" ODF	3/8" ODF	CR47KQ*	7/8" ODF	1/2" ODF
CF06K6*	3/4" ODF	3/8" ODF	CR53KQ*	7/8" ODF	1/2" ODF
CF09K6*	3/4" ODF	1/2" ODF	CRA1-0150*	5/8" ODF	3/8" ODF
CF12K6*	3/4" ODF	1/2" ODF	CRB1-0175*	5/8" ODF	3/8" ODF
CR16K6*	3/4" ODF	3/8" ODF	CRC1-0175*	5/8" ODF	3/8" ODF
CR16KQ*	5/8" ODF	3/8" ODF	CRD1-0200*	5/8" ODF	3/8" ODF
CR18K6*	3/4" ODF	3/8" ODF	CRE2-0225*	5/8" ODF	3/8" ODF
CR18KQ*	5/8" ODF	3/8" ODF	CRF2-0250*	3/4" ODF	3/8" ODF
CR20K6*	3/4" ODF	3/8" ODF	CRG3-0250*	3/4" ODF	3/8" ODF
CR20KQ*	5/8" ODF	3/8" ODF	CRH3-0275*	3/4" ODF	3/8" ODF
CR22K6*	3/4" ODF	3/8" ODF	CRJ3-0300*	3/4" ODF	3/8" ODF
CR22KQ*	5/8" ODF	3/8" ODF	CRK3-0325*	3/4" ODF	3/8" ODF
CR24K6*	5/8" ODF	3/8" ODF	CRL3-0350*	7/8" ODF	1/2" ODF
CR24KQ*	5/8" ODF	3/8" ODF	CRM3-0400*	7/8" ODF	1/2" ODF
CR28K6*	3/4" ODF	1/2" ODF	CRN5-0500*	7/8" ODF	1/2" ODF
CR28KQ*	5/8" ODF	3/8" ODF	CRP5-0450*	7/8" ODF	1/2" ODF
CR30K6*	3/4" ODF	3/8" ODF	CRT5-0450*	7/8" ODF	1/2" ODF
CR30KF*	3/4" ODF	3/8" ODF	CS10K6*	3/4" ODF	3/8" ODF
CR30KQ*	5/8" ODF	3/8" ODF	CS12K6*	3/4" ODF	3/8" ODF
CR32K6*	3/4" ODF	1/2" ODF	CS14K6*	3/4" ODF	3/8" ODF
CR32KQ*	5/8" ODF	3/8" ODF	CS18K6*	3/4" ODF	3/8" ODF
CR33KQ*	3/4" ODF	3/8" ODF	CS20K6*	3/4" ODF	1/2" ODF
CR34K6*	3/4" ODF	3/8" ODF	CS27K3*	3/4" ODF	1/2" ODF
CR34KQ*	3/4" ODF	3/8" ODF	CS27K6*	3/4" ODF	1/2" ODF
CR35K6*	3/4" ODF	1/2" ODF	CS33K3*	7/8" ODF	1/2" ODF
CR35KF*	3/4" ODF	1/2" ODF	CS33K6*	7/8" ODF	1/2" ODF
CR37KQ*	3/4" ODF	3/8" ODF	CTH1-0275*	7/8" ODF	1/2" ODF
CR38K6*	3/4" ODF	3/8" ODF	CTL1-0350*	7/8" ODF	1/2" ODF
CR41KQ*	3/4" ODF	3/8" ODF	CTN1-0500*	7/8" ODF	1/2" ODF
CR42K6*	3/4" ODF	1/2" ODF	CTN1-0501*	7/8" ODF	1/2" ODF

Standard connection sizes are shown above. The connection sizes may vary on special OEM Bill of Materials.

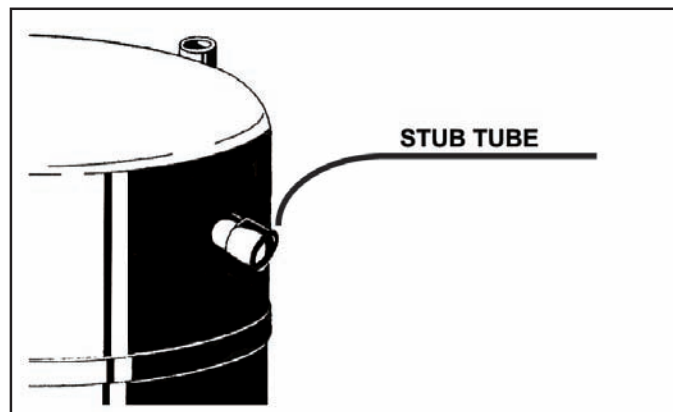

R-model Sweat Connection Sizes

Model	Suction Connection Size	Discharge Connection Size
REB3-0150*	1/2" ODF	1/3" ODF
REK3-0125*	1/2" ODF	1/3" ODF
REL3-0200*	1/2" ODF	1/3" ODF
RES3-0175*	1/2" ODF	1/3" ODF
REY3-0175*	1/2" ODF	1/3" ODF
REZ3-0125*	1/2" ODF	1/3" ODF
RF18C1*	1/2" ODF	3/8" ODF
RF18C2*	1/2" ODF	3/8" ODF
RF40C1*	1/2" ODF	3/8" ODF
RF41C1*	1/2" ODF	3/8" ODF
RF41C5*	1/2" ODF	3/8" ODF
RF42C1*	1/2" ODF	3/8" ODF
RFT18C1*	3/8" ODF	1/4" ODF
RFT22C1*	3/8" ODF	1/4" ODF
RFT26C1*	3/8" ODF	1/4" ODF
RFT29C1*	3/8" ODF	1/4" ODF
RFT32C1*	3/8" ODF	1/4" ODF
RFT42C1*	3/8" ODF	1/4" ODF
RR10K1*	1/2" ODF	3/8" ODF
RR10K2*	1/2" ODF	3/8" ODF
RR12K1*	1/2" ODF	3/8" ODF
RR14K1*	1/2" ODF	1/3" ODF
RR16K1*	1/2" ODF	3/8" ODF
RR17K1*	1/2" ODF	1/3" ODF
RR20K1*	1/2" ODF	1/3" ODF
RR81C1*	1/2" ODF	3/8" ODF
RR81C2*	1/2" ODF	3/8" ODF
RRG4-0100*	3/8" ODF	1/4" ODF
RRK4-0126*	3/8" ODF	1/4" ODF
RRL4-0100*	1/2" ODF	1/4" ODF
RRL6-0100*	1/2" ODF	1/4" ODF
RRS4-0075*	1/2" ODF	1/4" ODF
RRT10K1*	1/2" ODF	3/8" ODF
RRT62C1*	3/8" ODF	1/4" ODF
RRT64C1*	3/8" ODF	1/4" ODF
RRT73C1*	3/8" ODF	1/4" ODF
RRT81C1*	1/2" ODF	3/8" ODF
RS40C1*	1/2" ODF	3/8" ODF
RS40C2*	1/2" ODF	3/8" ODF
RS43C1*	1/2" ODF	3/8" ODF

Model	Suction Connection Size	Discharge Connection Size
RS43C2*	1/2" ODF	3/8" ODF
RS47C2*	3/8" ODF	1/4" ODF
RS54C1*	1/2" ODF	3/8" ODF
RS54C2*	1/2" ODF	3/8" ODF
RS55C1*	1/2" ODF	3/8" ODF
RS55C2*	1/2" ODF	3/8" ODF
RS64C1*	1/2" ODF	3/8" ODF
RS64C2*	1/2" ODF	3/8" ODF
RS70C1*	1/2" ODF	3/8" ODF
RS80C1*	1/2" ODF	3/8" ODF
RS80C2*	1/2" ODF	3/8" ODF
RS86C2*	1/2" ODF	3/8" ODF
RS97C1*	1/2" ODF	3/8" ODF
RS97C2*	1/2" ODF	3/8" ODF
RS97CE*	1/2" ODF	3/8" ODF
RSE4-0075*	3/8" ODF	1/4" ODF
RSE4-0076*	3/8" ODF	1/4" ODF
RSF2-0050*	3/8" ODF	1/4" ODF
RSL2-0075*	1/2" ODF	1/4" ODF
RSL2-0100*	1/2" ODF	1/4" ODF
RSL2-0101*	1/2" ODF	1/4" ODF
RSL5-0101*	1/2" ODF	3/8" ODF
RSN4-0050*	3/8" ODF	1/4" ODF
RSN4-0075*	3/8" ODF	1/4" ODF
RSN4-0100*	3/8" ODF	1/4" ODF
RSN5-0075*	1/2" ODF	1/4" ODF
RSN6-0075*	3/8" ODF	1/4" ODF
RSU4-0050*	3/8" ODF	1/4" ODF
RSU5-0050*	3/8" ODF	1/4" ODF
RST10K1*	1/2" ODF	3/8" ODF
RST40C1*	3/8" ODF	1/4" ODF
RST45C1*	3/8" ODF	1/4" ODF
RST55C1*	3/8" ODF	1/4" ODF
RST61C1*	3/8" ODF	1/4" ODF
RST64C1*	3/8" ODF	1/4" ODF
RST70C1*	1/2" ODF	3/8" ODF
RST80C1*	1/2" ODF	3/8" ODF
RST97C1*	1/2" ODF	3/8" ODF

Standard connection sizes are shown above. The connection sizes may vary on special OEM Bill of Materials.

Quick Reference Guide

Z-model Sweat Connection Sizes

Model	Suction Connection Size	Discharge Connection Size
1.3 - 2.0 HP		
ZB10K	3/4" ODF	1/2" ODF
ZB11K	3/4" ODF	1/2" ODF
ZB13K	3/4" ODF	1/2" ODF
ZB14K	3/4" ODF	1/2" ODF
ZP14K	3/4" ODF	1/2" ODF
ZP16K	3/4" ODF	1/2" ODF
ZP20K	3/4" ODF	1/2" ODF
ZP21K	3/4" ODF	1/2" ODF
ZP22K	3/4" ODF	1/2" ODF
ZP23K	3/4" ODF	1/2" ODF
ZP24K	3/4" ODF	1/2" ODF
ZR16K	3/4" ODF	1/2" ODF
ZR18K	3/4" ODF	1/2" ODF
ZR18K	3/4" ODF	1/2" ODF
ZR21K	3/4" ODF	1/2" ODF
ZR22K	3/4" ODF	1/2" ODF
ZR24K	3/4" ODF	1/2" ODF
ZS09K	3/4" ODF	1/2" ODF
ZS11K	3/4" ODF	1/2" ODF
ZS13K	3/4" ODF	1/2" ODF
2.0 - 3.5 HP		
ZB15K	3/4" ODF	1/2" ODF
ZB19K	3/4" ODF	1/2" ODF
ZB21K	3/4" ODF	1/2" ODF
ZB26K	3/4" ODF	1/2" ODF
ZB29K	7/8" ODF	1/2" ODF
ZF06K	3/4" ODF	1/2" ODF
ZF08K	3/4" ODF	1/2" ODF
ZF09K	3/4" ODF	1/2" ODF
ZF11K	3/4" ODF	1/2" ODF
ZP25K	3/4" ODF	1/2" ODF
ZP26K	3/4" ODF	1/2" ODF
ZP28K	3/4" ODF	1/2" ODF
ZP29K	3/4" ODF	1/2" ODF
ZP31K	3/4" ODF	1/2" ODF
ZP32K	3/4" ODF	1/2" ODF
ZP34K	7/8" ODF	1/2" ODF
ZP36K3	3/4" ODF	1/2" ODF
ZP36K5	7/8" ODF	1/2" ODF
ZP38K3/C	3/4" ODF	1/2" ODF
ZP38K5	7/8" ODF	1/2" ODF

Model	Suction Connection Size	Discharge Connection Size
2.0 - 3.5 HP (cont.)		
ZP39K	7/8" ODF	1/2" ODF
ZP41K	3/4" ODF	1/2" ODF
ZP42K	7/8" ODF	1/2" ODF
ZP44K3/C	3/4" ODF	1/2" ODF
ZP44K5	7/8" ODF	1/2" ODF
ZR25K	3/4" ODF	1/2" ODF
ZR26K	3/4" ODF	1/2" ODF
ZR28K	3/4" ODF	1/2" ODF
ZR30K	3/4" ODF	1/2" ODF
ZR32K	3/4" ODF	1/2" ODF
ZR34K	3/4" ODF	1/2" ODF
ZR35K	3/4" ODF	1/2" ODF
ZR36K	3/4" ODF	1/2" ODF
ZR38K	7/8" ODF	1/2" ODF
ZR40K	3/4" ODF	1/2" ODF
ZR42K3	3/4" ODF	1/2" ODF
ZR42K5	7/8" ODF	1/2" ODF
ZR44K	7/8" ODF	1/2" ODF
ZR45K	7/8" ODF	1/2" ODF
ZR46K	7/8" ODF	1/2" ODF
ZS15K	3/4" ODF	1/2" ODF
ZS19K	3/4" ODF	1/2" ODF
ZS21K	3/4" ODF	1/2" ODF
ZS26K	3/4" ODF	1/2" ODF
4.0 - 6.0 HP		
ZB30K	7/8" ODF	1/2" ODF
ZB38K	7/8" ODF	1/2" ODF
ZB42K	7/8" ODF	1/2" ODF
ZB45K	7/8" ODF	1/2" ODF
ZB48K	7/8" ODF	3/4" ODF
ZF13K	7/8" ODF	1/2" ODF
ZF15K	7/8" ODF	1/2" ODF
ZF18K	7/8" ODF	1/2" ODF
ZP50K	7/8" ODF	1/2" ODF
ZP51K	7/8" ODF	1/2" ODF
ZP54K	7/8" ODF	1/2" ODF
ZP57K	7/8" ODF	1/2" ODF
ZP61K	7/8" ODF	1/2" ODF
ZP67K	7/8" ODF	1/2" ODF
ZP70K	7/8" ODF	1/2" ODF
ZP72K	7/8" ODF	1/2" ODF

Standard connection sizes are shown above. The connection sizes may vary on special OEM Bill of Materials.

Z-model Sweat Connection Sizes

Model	Suction Connection Size	Discharge Connection Size
4.0 - 6.0 HP (cont.)		
ZP76K	7/8" ODF	1/2" ODF
ZP83K	7/8" ODF	1/2" ODF
ZR49K	7/8" ODF	1/2" ODF
ZR54K	7/8" ODF	1/2" ODF
ZR57K	7/8" ODF	1/2" ODF
ZR61K	7/8" ODF	1/2" ODF
ZR67K	7/8" ODF	1/2" ODF
ZR68K	7/8" ODF	1/2" ODF
ZR72K	7/8" ODF	1/2" ODF
ZR80K	7/8" ODF	3/4" ODF
ZR81K	7/8" ODF	3/4" ODF
ZS29K	7/8" ODF	1/2" ODF
ZS30K	7/8" ODF	1/2" ODF
ZS33K	7/8" ODF	1/2" ODF
ZS38K	7/8" ODF	1/2" ODF
ZS45K	7/8" ODF	1/2" ODF
7.0 - 15.0 HP		
ZB50K	1-1/8" ODF	7/8" ODF
ZB58K	1-1/8" ODF	7/8" ODF
ZB66K	1-3/8" ODF	7/8" ODF
ZB76K	1-3/8" ODF	7/8" ODF
ZB88K	1-3/8" ODF	7/8" ODF
ZB95K	1-3/8" ODF	7/8" ODF
ZB114K	1-3/8" ODF	7/8" ODF
ZF25K	7/8" ODF	3/4" ODF
ZR84K	1-1/8" ODF	7/8" ODF
ZR94K	1-1/8" ODF	7/8" ODF
ZR11M	1-3/8" ODF	7/8" ODF
ZR108K	1-3/8" ODF	7/8" ODF
ZR125K	1-3/8" ODF	7/8" ODF
ZR144K	1-3/8" ODF	7/8" ODF
ZR160K	1-3/8" ODF	7/8" ODF
ZR190K	1-3/8" ODF	7/8" ODF
ZP90K	1-1/8" ODF	7/8" ODF
ZP91K	7/8" ODF	3/4" ODF
ZP103K	1-3/8" ODF	7/8" ODF
ZP104K	1-1/8" ODF	7/8" ODF
ZP120K	1-3/8" ODF	7/8" ODF
ZP137K	1-3/8" ODF	7/8" ODF
ZP154K	1-3/8" ODF	7/8" ODF
ZP181K	1-3/8" ODF	7/8" ODF

Model	Suction Connection Size	Discharge Connection Size
7.5 - 15.0 HP		
ZB11M	1-5/8" ODF	1-3/8" ODF
ZB56K	1-3/8" ODF	7/8" ODF
ZB68K	1-3/8" ODF	7/8" ODF
ZB75K	1-3/8" ODF	7/8" ODF
ZB92K	1-3/8" ODF	7/8" ODF
ZF24K	1-3/8" ODF	7/8" ODF
ZF33K	1-3/8" ODF	7/8" ODF
ZF40K	1-3/8" ODF	7/8" ODF
ZF48K	1-5/8" ODF	1-3/8" ODF
ZR11M	1-3/8" ODF	7/8" ODF
ZR12M	1-3/8" ODF	7/8" ODF
ZR16M	1-3/8" ODF	7/8" ODF
ZR19M	1-5/8" ODF	1-1/8" ODF
ZR90K	1-3/8" ODF	7/8" ODF
ZS11M	1-5/8" ODF	1-3/8" ODF
ZS56K	1-3/8" ODF	7/8" ODF
ZS75K	1-3/8" ODF	7/8" ODF
ZS92K	1-3/8" ODF	7/8" ODF
ZP180K	1-5/8" ODF	1-1/8" ODF
LCS		
ZR250K	1-5/8" ODF	1-3/8" ODF
ZR300K	2-1/8" ODF	1-3/8" ODF
ZR310K	1-5/8" ODF	1-3/8" ODF
ZR380K	1-5/8" ODF	1-3/8" ODF
ZP235K	1-5/8" ODF	1-3/8" ODF
ZP236K	1-5/8" ODF	1-3/8" ODF
ZP285K	2-1/8" ODF	1-3/8" ODF
ZP295K	1-5/8" ODF	1-3/8" ODF
ZP296K	1-5/8" ODF	1-3/8" ODF
ZP385K	1-5/8" ODF	1-3/8" ODF
ZP485K	1-5/8" ODF	1-3/8" ODF

Standard connection sizes are shown above. The connection sizes may vary on special OEM Bill of Materials.

Single Rotalock Valve Kits

Kit Number	Connection Size	Thread Size	Valve Part Number	Gasket Part Number
998-0510-42	3/8" Flare	1 - 14 UNC	510-0132-02	020-0028-00
998-0510-43	3/8" Sweat	1 - 14 UNC	510-0133-00	020-0028-00
998-0510-40	1/2" Flare	1 - 14 UNC	510-0132-00	020-0028-00
998-0510-44	1/2" Sweat	1 - 14 UNC	510-0133-09	020-0028-00
998-0510-41	5/8" Flare	1 - 14 UNC	510-0132-01	020-0028-00
998-0510-45	5/8" Sweat	1 - 14 UNC	510-0133-02	020-0028-00
998-0510-52	7/8" Sweat	1 - 14 UNC	510-0133-13	020-0028-00
998-0510-38	3/4" Sweat	1-1/4 - 12 UNC	510-0080-04	020-0028-02
998-0510-90	7/8" Sweat	1-1/4 - 12 UNC	510-0133-04	020-0028-02
998-0510-51	1-1/8" Sweat	1-1/4 - 12 UNC	510-0133-12	020-0028-02
998-0510-37	7/8" Sweat	1-3/4 - 12 UNC	510-0330-02	020-0028-03
998-0510-02	1-1/8" Sweat	1-3/4 - 12 UNC	510-0330-01	020-0028-03
998-0510-46	1-3/8" Sweat	1-3/4 - 12 UNC	510-0330-00	020-0028-03
998-0510-66	1-5/8" Sweat	1-3/4 - 12 UNC	510-0323-00	020-0028-03
998-0510-67	1-3/8" Sweat	2-1/4 - 12 UNC	510-0402-01	020-0941-00
998-0510-68	1-5/8" Sweat	2-1/4 - 12 UNC	510-0402-00	020-0941-00



Suction and Discharge Rotalock Valve Kits

Kit Number	Suction Size/Style	Suction Thread Size	Discharge Size/Style	Discharge Thread Size
998-5100-24	1-1/8" Sweat	1-3/4 - 12 UNC	3/4" Sweat	1-1/4 - 12 UNC
998-5100-17	1-1/8" Sweat	1-3/4 - 12 UNC	7/8" Sweat	1-1/4 - 12 UNC
998-5100-16	1-3/8" Sweat	1-3/4 - 12 UNC	3/4" Sweat	1-1/4 - 12 UNC
998-5100-27	1-3/8" Sweat	1-3/4 - 12 UNC	7/8" Sweat	1-1/4 - 12 UNC
998-5100-41	1-3/8" Sweat	2-1/4 - 12 UNC	1-1/8" Sweat	1-3/4 - 12 UNC
998-5100-39	1-5/8" Sweat	2-1/4 - 12 UNC	1-1/8" Sweat	1-3/4 - 12 UNC
998-5100-38	1-5/8" Sweat	2-1/4 - 12 UNC	1-3/8" Sweat	1-3/4 - 12 UNC

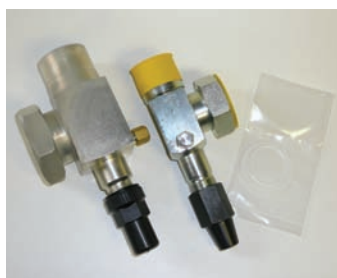

Stub Tube to Rotalock Adapter Kits

Kit Part Number	Stub Tube I.D.	Thread Size
998-0034-14	3/8"	1" - 14
998-0034-15	1/2"	1" - 14
998-0034-16	5/8"	1" - 14
998-0034-01	3/4"	1-1/4" - 12
998-0034-02	7/8"	1-1/4" - 12
998-0034-03	1-1/8"	1-3/4" - 12
998-0034-04	1-3/8"	1-3/4" - 12
998-0034-06	1-5/8"	2-1/4" - 12

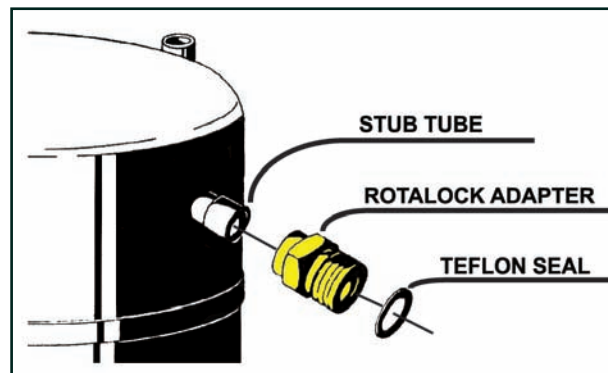

Rotalock to Stub Tube Adapter Kits

Kit Part Number	Thread Size	I.D.
998-0034-18	1" - 14	1/2"
998-0034-17	1" - 14	5/8"
998-0034-07	1-1/4" - 12	3/4"
998-0034-08	1-1/4" - 12	7/8"
998-0034-09	1-1/4" - 12	1-1/8"
998-0034-10	1-3/4" - 12	1-1/8"
998-0034-13	1-3/4" - 12	1-3/8"
998-0034-11	2-1/4" - 12	1-3/8"
998-0034-12	2-1/4" - 12	1-5/8"

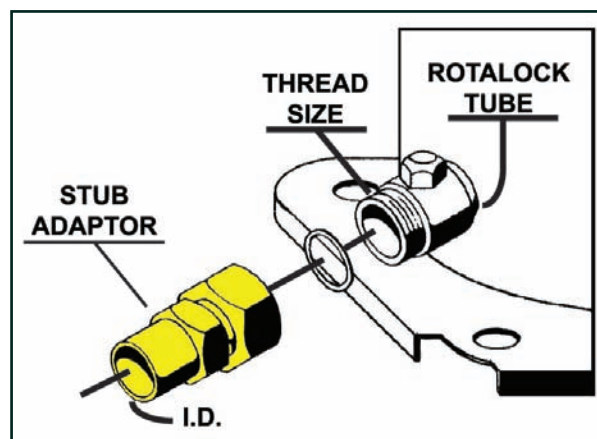

Quick Reference Guide

Semi-Hermetic Compressor Oil Charges

Discus Models

Model Family	Standard		Deep Sump	
	Initial	Recharge	Initial	Recharge
2D	80	72	110	95
3D	115	105	190	170
4DA3A100E	140	130	-	-
4DL3A150E	135	120	250	235
4DA3A200E	135	120	250	235
4DT3A220E	130	120	245	235
4DH3A250E	130	120	245	235
4DJ3A300E	140	125	255	240
4DA3R12ME	140	130	-	-
4DL3F63KE	135	120	250	235
4DA3R18ME	135	120	250	235
4DT3F76KE	130	120	245	235
4DH3R22ME	130	120	245	235
4DJ3R28ME	140	125	255	240
6D	140	130	255	245
6DT3A300*	255	245	255	245
6DJ3A400*	255	245	255	245
6DT3F11M*	255	245	255	245
6DJ3R40M*	255	245	255	245

Non-Discus Models

Model Family	Standard		Deep Sump	
	Initial	Recharge	Initial	Recharge
H	22	16	-	-
K	22	20	-	-
E	60	55	-	-
3	70	65	-	-
L	80	75	-	-
M	80	70	110	95
N	70	70	-	-
4RA	135	120	250	235
4RH	130	120	245	235
4RJ	140	125	255	240
6R	140	130	255	245
9R	115	105	165	155

3D Moduload

3DE3-0500-TFC
 3DE3-0500-TFD
 3DE3-0500-TFE
 3DE3-0750-TFC
 3DE3-0750-TFD
 3DE3-0750-TFE
 3DE3-075E-TFC
 3DE3-075E-TFD
 3DE3-075E-TFE
 3DG3-0900-TFC
 3DG3-0900-TFD
 3DG3-0900-TFE
 3DG3-090E-TFC
 3DG3-090E-TFD
 3DG3-090E-TFE
 3DGH-090E-TFC
 3DGH-090E-TFD
 3DGH-090E-TFE
 3DH3-0600-TFC
 3DH3-0600-TFD
 3DH3-0600-TFE
 3DH3-060E-TFC
 3DH3-060E-TFD
 3DH3-060E-TFE
 3DHH-060E-TFC
 3DHH-060E-TFD
 3DHH-060E-TFE
 3DJ3-0750-TFC
 3DJ3-0750-TFD
 3DJ3-0750-TFE
 3DJ3-075E-TFC
 3DJ3-075E-TFD
 3DJ3-075E-TFE
 3DJH-075E-TFC
 3DJH-075E-TFD
 3DJH-075E-TFE
 3DK3-0750-TFC
 3DK3-0750-TFD
 3DK3-0900-TFC
 3DK3-0900-TFD
 3DK3-0900-TFE
 3DK3-1200-TFC
 3DK3-1200-TFD

3DK3-120E-TFC
 3DK3-120E-TFD
 3DK4-1200-TFD
 3DK8-0750-TFC
 3DK8-0750-TFD
 3DK8-075E-TFD
 3DKB-0750-TFC
 3DKB-0750-TFD
 3DKH-120E-TFC
 3DKH-120E-TFD
 3DP3-0500-FSM
 3DP3-0500-TFC
 3DP3-0500-TFD
 3DP3-0500-TFE
 3DP3-0750-TFC
 3DP3-0750-TFD
 3DP3-0750-TFE
 3DP3-075E-TFD
 3DP3-1000-TFC
 3DP3-1000-TFD
 3DP3-1000-TFE
 3DP3-100E-TFC
 3DP3-100E-TFD
 3DP3-100E-TFE
 3DPH-100E-TFC
 3DPH-100E-TFD
 3DPH-100E-TFE
 3DR3-1000-TFC
 3DR3-1000-TFD
 3DR3-1000-TFE
 3DR3-100E-TFC
 3DR3-100E-TFD
 3DR3-100E-TFE
 3DRH-100E-TFC
 3DRH-100E-TFD
 3DRH-100E-TFE
 3DE3A0500-TFC
 3DE3A0500-TFD
 3DE3A0500-TFE
 3DE3A0750-TFC
 3DE3A0750-TFD
 3DE3A0750-TFE

3DE3A075E-TFD
 3DE3A075E-TFE
 3DEHA075E-TFC
 3DEHA075E-TFD
 3DEHA075E-TFE
 3DG3A0900-TFC
 3DG3A0900-TFE
 3DG3A090E-TFC
 3DG3A090E-TFD
 3DG3A090E-TFE
 3DGHA090E-TFC
 3DGHA090E-TFD
 3DGHA090E-TFE
 3DH3A0600-TFC
 3DH3A0600-TFD
 3DH3A0600-TFE
 3DH3A060E-TFC
 3DH3A060E-TFD
 3DH3A060E-TFE
 3DHHA060E-TFC
 3DHHA060E-TFD
 3DHHA060E-TFE
 3DJ3A0750-TFC
 3DJ3A0750-TFD
 3DJ3A0750-TFE
 3DJ3A075E-TFC
 3DJ3A075E-TFD
 3DJ3A075E-TFE
 3DJHA075E-TFC
 3DJHA075E-TFD
 3DJHA075E-TFE
 3DK3A0750-TFC
 3DK3A0750-TFD
 3DK3A0900-TFC
 3DK3A0900-TFD
 3DK3A0900-TFE
 3DK3A1200-TFC
 3DK3A1200-TFD
 3DK3A120E-TFC
 3DK3A120E-TFD
 3DKHA120E-TFC
 3DKHA120E-TFD
 3DP3A0500-TFC

3DP3A0500-TFD
 3DP3A0500-TFE
 3DP3A0750-TFC
 3DP3A0750-TFD
 3DP3A0750-TFE
 3DP3A075E-TFD
 3DP3A1000-TFC
 3DP3A1000-TFD
 3DP3A1000-TFE
 3DP3A100E-TFC
 3DP3A100E-TFD
 3DP3A100E-TFE
 3DPHA100E-TFC
 3DPHA100E-TFD
 3DPHA100E-TFE
 3DR3A1000-TFC
 3DR3A1000-TFD
 3DR3A1000-TFE
 3DRHA100E-TFC
 3DRHA100E-TFD
 3DRHA100E-TFE
 3DT3A0750-TFC
 3DT3A0750-TFD
 3DT3A0750-TFE
 3DT3A1000-TFC
 3DT3A1000-TFD
 3DT3A1000-TFE
 3DT3A1500-TFC
 3DT3A1500-TFD
 3DT3A1500-TFE
 3DT3A150E-TFC
 3DT3A150E-TFD
 3DT3A150E-TFE
 3DTHA150E-TFC
 3DTHA150E-TFD
 3DTHA150E-TFE

Quick Reference Guide

- 4DC3-2200-FSD
- 4DC3-2200-TSE
- 4DC3-2200-TSK
- 4DC3-220E-FSD
- 4DC3-220E-TSE
- 4DC3-220E-TSK
- 4DE1-1000-TSE
- 4DE1-1000-TSK
- 4DE1-2000-FSD
- 4DE1-2000-TSE
- 4DE1-2000-TSK
- 4DE2-2000-TSK
- 4DE3-100E-TSK
- 4DE3-2000-FSD
- 4DE3-2000-TSE
- 4DE3-2000-TSK
- 4DE3-200E-FSD
- 4DE3-200E-TSE
- 4DE3-200E-TSK
- 4DE4-2000-TSK
- 4DE5-2000-TSK
- 4DE8-2000-FSD
- 4DE8-200E-TSK
- 4DK1-1500-TSK
- 4DK1-2500-FSD
- 4DK1-2500-TSE
- 4DK1-2500-TSK
- 4DK3-150E-FSM
- 4DK3-150E-TSE
- 4DK3-150E-TSK
- 4DK3-2500-FSD
- 4DK3-2500-TSE
- 4DK3-2500-TSK
- 4DK3-250E-FSD
- 4DK3-250E-TSE
- 4DK3-250E-TSK
- 4DN1-1000-FSD
- 4DN1-1000-TSE
- 4DN1-1000-TSK
- 4DN3-1000-FSD
- 4DN3-1000-TSE
- 4DN3-1000-TSK
- 4DN3-100E-FSD
- 4DN3-100E-TSE
- 4DN3-1010-TSE
- 4DN3-1010-TSK
- 4DN3-101E-TSE
- 4DN3-101E-TSK
- 4DP1-1500-FSD
- 4DP1-1500-TSK
- 4DP3-1500-FSD
- 4DP3-1500-TSE
- 4DP3-1500-TSK
- 4DP3-150E-FSD
- 4DP3-150E-TSE
- 4DP3-150E-TSK
- 4DP8-1500-TSK
- 4DP8-150E-TSK
- 4DR1-2000-TSE
- 4DR1-2000-TSK
- 4DR1-3000-FSD
- 4DR1-3000-TSE
- 4DR1-3000-TSK
- 4DR3-200E-FSM
- 4DR3-200E-TSE
- 4DR3-200E-TSK
- 4DR3-3000-FSD
- 4DR3-3000-TSE
- 4DR3-3000-TSK
- 4DR3-300E-FSD
- 4DR3-300E-TSE
- 4DR3-300E-TSK
- 4DR8-200E-TSK
- 4DRB-2000-TSE
- 4DRB-2000-TSK
- 4DS1-2200-FSD
- 4DS1-2200-TSE
- 4DS1-2200-TSK
- 4DS3-2200-FSD
- 4DS3-2200-TSE
- 4DS3-2200-TSK
- 4DS3-220E-FSD
- 4DS3-220E-TSE
- 4DS3-220E-TSK
- 4DC3A2200-TSE
- 4DC3A2200-TSK
- 4DC3A220E-FSD
- 4DC3A220E-TSE
- 4DC3A220E-TSK
- 4DE1A1000-TSE
- 4DE1A1000-TSK
- 4DE1A2000-FSD
- 4DE1A2000-TSE
- 4DE1A2000-TSK
- 4DE2A2000-TSK
- 4DE3A100E-TSK
- 4DE3A2000-FSD
- 4DE3A2000-TSE
- 4DE3A2000-TSK
- 4DE3A200E-FSD
- 4DE3A200E-TSE
- 4DE3A200E-TSK
- 4DE4A2000-TSK
- 4DE8A2000-FSD
- 4DE8A200E-TSK
- 4DK1A1500-TSK
- 4DK1A2500-FSD
- 4DK1A2500-TSE
- 4DK3A150E-FSM
- 4DK3A150E-TSE
- 4DK3A150E-TSK
- 4DK3A2500-FSD
- 4DK3A2500-TSE
- 4DK3A2500-TSK
- 4DK3A250E-FSD
- 4DK3A250E-TSE
- 4DK3A250E-TSK
- 4DN1A1000-FSD
- 4DN1A1000-TSE
- 4DN1A1000-TSK
- 4DN3A1000-FSD
- 4DN3A1000-TSE
- 4DN3A1000-TSK
- 4DN3A100E-FSD
- 4DN3A100E-TSE
- 4DN3A1010-TSE
- 4DN3A1010-TSK
- 4DN3A101E-TSE
- 4DN3A101E-TSK
- 4DP1A1500-FSD
- 4DP1A1500-TSK
- 4DC3A220E-TSK
- 4DE1A1000-TSE
- 4DE1A1000-TSK
- 4DE1A2000-FSD
- 4DE1A2000-TSE
- 4DE1A2000-TSK
- 4DE2A2000-TSK
- 4DE3A100E-TSK
- 4DE3A2000-FSD
- 4DE3A2000-TSE
- 4DE3A2000-TSK
- 4DE3A200E-FSD
- 4DE3A200E-TSE
- 4DE3A200E-TSK
- 4DE4A2000-TSK
- 4DE8A2000-FSD
- 4DE8A200E-TSK
- 4DK1A1500-TSK
- 4DK1A2500-FSD
- 4DK1A2500-TSE
- 4DK3A150E-FSM
- 4DK3A150E-TSE
- 4DK3A150E-TSK
- 4DK3A2500-FSD
- 4DK3A2500-TSE
- 4DK3A2500-TSK
- 4DK3A250E-FSD
- 4DK3A250E-TSE
- 4DK3A250E-TSK
- 4DN1A1000-FSD
- 4DN1A1000-TSE
- 4DN1A1000-TSK
- 4DN3A1000-FSD
- 4DN3A1000-TSE
- 4DN3A1000-TSK
- 4DN3A100E-FSD
- 4DN3A100E-TSE
- 4DN3A1010-TSE
- 4DN3A1010-TSK
- 4DN3A101E-TSE
- 4DN3A101E-TSK
- 4DP1A1500-FSD
- 4DP1A1500-TSK
- 4DP3A1500-FSD
- 4DP3A1500-TSE
- 4DP3A1500-TSK
- 4DP3A150E-FSD
- 4DP3A150E-TSE
- 4DP3A150E-TSK
- 4DP8A1500-TSK
- 4DP8A150E-TSK
- 4DR1A2000-TSE
- 4DR1A2000-TSK
- 4DR1A3000-FSD
- 4DR1A3000-TSE
- 4DR1A3000-TSK
- 4DR3A200E-TSE
- 4DR3A200E-TSK
- 4DR3A3000-FSD
- 4DR3A3000-TSE
- 4DR3A3000-TSK
- 4DR3A300E-FSD
- 4DR3A300E-TSE
- 4DR3A300E-TSK
- 4DR8A200E-TSK
- 4DS1A2200-FSD
- 4DS1A2200-TSE
- 4DS1A2200-TSK
- 4DS3A2200-FSD
- 4DS3A2200-TSE
- 4DS3A2200-TSK
- 4DS3A220E-FSD
- 4DS3A220E-TSE
- 4DS3A220E-TSK
- 4RE2-1000-FSM
- 4RE2-1000-TSE
- 4RE2-1000-TSK
- 4RE2-2000-FSD
- 4RE2-2000-TSE
- 4RE2-2000-TSK
- 4RK2-1500-FSM
- 4RK2-1500-TSE
- 4RK2-1500-TSK
- 4RK2-2500-FSD
- 4RK2-2500-TSE
- 4RK2-2500-TSK
- 4RR1-3000-FSD
- 4RR1-3000-TSE
- 4RR1-3000-TSK
- 4RR2-3000-FSD
- 4RR2-3000-TSE
- 4RR2-3000-TSK
- D 4DBXF54KE-TSE
- D 4DBXF54KE-TSK
- D 4DBXR20ME-FSD
- D 4DBXR20ME-TSE
- D 4DBXR20ME-TSK
- 4DCNF54KE-TSE
- 4DCNF54KE-TSK
- 4DCNR20ME-FSD
- 4DCNR20ME-TSE
- 4DCNR20ME-TSK
- D 4DHXF63KE-FSD
- D 4DHXF63KE-TSE
- D 4DHXF63KE-TSK
- D 4DHXR22ME-FSD
- D 4DHXR22ME-TSE
- D 4DHXR22ME-TSK
- D 4DJXF76ME-FSD
- D 4DJXF76ME-TSE
- D 4DJXF76ME-TSK
- D 4DJXR28ME-FSD
- D 4DJXR28ME-TSE
- D 4DJXR28ME-TSK
- 4DKNF63KE-FSD
- 4DKNF63KE-TSE
- 4DKNF63KE-TSK
- 4DKNR16ME-TSE
- 4DKNR16ME-TSK
- 4DKNR22ME-FSD
- 4DKNR22ME-TSE
- 4DKNR22ME-TSK
- 4DRNF76KE-FSD
- 4DRNF76KE-TSE
- 4DRNF76KE-TSK
- 4DRNR19ME-TSK
- 4DRNR28ME-FSD
- 4DRNR28ME-TSE
- 4DRNR28ME-TSK

D = Digital Model
 • = 1 Bank Unloading

Quick Reference Guide

- 6DK3A350E-TSK
- 6DM3A3500-FSD
- 6DM3A3500-FSU
- 6DM3A3500-TSE
- 6DM3A3500-TSN
- 6DM3A350E-FSD
- 6DM3A350E-FSU
- 6DM3A350E-TSE
- 6DM3A350E-TSN
- 6DN3A3500-FSD
- 6DN3A3500-FSU
- 6DN3A3500-TSE
- 6DN3A3500-TSN
- 6DN3A350E-FSD
- 6DN3A350E-FSU
- 6DN3A350E-TSE
- 6DN3A350E-TSN
- 6DP1A2000-TSK
- 6DP1A3500-FSD
- 6DP1A3500-TSE
- 6DP1A3500-TSK
- 6DP1A350E-TSK
- 6DP3A200E-FSM
- 6DP3A200E-TSE
- 6DP3A200E-TSK
- 6DP3A3500-FSD
- 6DP3A3500-TSE
- 6DP3A3500-TSK
- 6DP3A350E-FSD
- 6DP3A350E-TSE
- 6DP3A350E-TSK
- 6DR1A4000-FSD
- 6DR1A4000-FSU
- 6DR1A4000-TSE
- 6DR1A4000-TSN
- 6DR3A300E-TSE
- 6DR3A300E-TSK
- 6DR3A4000-FSD
- 6DR3A4000-FSU
- 6DR3A4000-TSE
- 6DR3A4000-TSN
- 6DR3A400E-FSD
- 6DR3A400E-FSU
- 6DR3A400E-TSE
- 6DR3A400E-TSN
- 6DS1A4000-FSD
- 6DS1A4000-FSU
- 6DS1A4000-TSE
- 6DS1A4000-TSN
- 6DS3A300E-TSE
- 6DS3A300E-TSK
- 6DS3A4000-FSD
- 6DS3A4000-FSU
- 6DS3A4000-TSE
- 6DS3A4000-TSN
- 6DS3A400E-FSD
- 6DS3A400E-FSU
- 6DS3A400E-TSE
- 6DS3A400E-TSN
- 6DW3A3000-FSD
- 6DW3A3000-TSE
- 6DW3A3000-TSK
- 6DW3A300E-FSD
- 6DW3A300E-TSE
- 6DW3A300E-TSK
- 6DY3A3000-FSD
- 6DY3A3000-TSE
- 6DY3A300E-FSD
- 6DY3A300E-TSE
- 6DY3A300E-TSK
- 6RE2-2000-FSD
- 6RE2-2000-TSE
- 6RE2-2000-TSK
- 6RE2-3000-FSD
- 6RE2-3000-TSE
- 6RE2-3000-TSK
- 6RK2-2000-TSE
- 6RK2-2000-TSK
- 6RK2-3500-FSD
- 6RK2-3500-TSE
- 6RK2-3500-TSK
- 6RK5-3500-FSD
- 6RK5-3500-TSK
- 6RN2-2000-FSD
- 6RN2-2000-TSE
- 6RN2-2000-TSK
- 6RN2-3000-FSD
- 6RN2-3000-TSE
- 6RN2-3000-TSK
- 6RN5-3000-TSK
- 6RP2-2000-TSE
- 6RP2-2000-TSK
- 6RP2-3500-FSD
- 6RP2-3500-TSE
- 6RP2-3500-TSK
- 6RP5-3500-TSK
- 6RR2-4000-FSD
- 6RR2-4000-FSU
- 6RR2-4000-TSE
- 6RR2-4000-TSN
- 6RS2-4000-FSD
- 6RS2-4000-FSU
- 6RS2-4000-TSE
- 6RS2-4000-TSN
- D 6DBXR32ME-TSK
- D 6DGXR37ME-TSE
- D 6DGXR37ME-TSN
- D 6DHXF93KE-TSE
- D 6DHXF93KE-TSK
- D 6DHXR35ME-TSE
- D 6DHXR35ME-TSK
- D 6DJXF11ME-TSE
- D 6DJXF11ME-TSK
- D 6DJXR40ME-TSE
- D 6DJXR40ME-TSN
- 6DKNF93KE-FSD
- 6DKNF93KE-TSE
- 6DKNF93KE-TSK
- D 6DKXF93KE-TSE
- D 6DKXF93KE-TSK
- 6DKNR23ME-TSK
- 6DKNR35ME-FSD
- 6DKNR35ME-TSE
- 6DKNR35ME-TSK
- D 6DKXR35ME-TSE
- D 6DKXR35ME-TSK
- 6DMNR37ME-FSD
- 6DMNR37ME-FSU
- 6DMNR37ME-TSE
- 6DMNR37ME-TSN
- D 6DMXR37ME-TSE
- D 6DMXR37ME-TSN
- 6DRNF11ME-FSD
- 6DRNF11ME-TSE
- 6DRNF11ME-TSK
- 6DRNR28ME-TSK
- 6DRNR40ME-FSD
- 6DRNR40ME-FSU
- 6DRNR40ME-TSE
- 6DRNR40ME-TSN

D = Digital Model
 • = 1 Bank Unloading
 •• = 2 Banks Unloading

Digital Models

3D

3DADF28KE-TFC
 3DADF28KE-TFD
 3DADF28KE-TFE
 3DADR10ME-TFE
 3DBDF33KE-TFC
 3DBDF33KE-TFD
 3DBDF33KE-TFE
 3DBDR12ME-TFC
 3DBDR12ME-TFD
 3DBDR12ME-TFE
 3DFDF40KE-TFC
 3DFDF40KE-TFD
 3DFDF40KE-TFE
 3DFDR15ME-TFC
 3DFDR15ME-TFD
 3DSDF46KE-TFC
 3DSDF46KE-TFD
 3DSDF46KE-TFE
 3SDSR17ME-TFC
 3SDSR17ME-TFD
 3SDSR17ME-TFE

4D

4DBXF54KE-TSE
 4DBXF54KE-TSK
 4DBXR20ME-FSD
 4DBXR20ME-TSE
 4DBXR20ME-TSK
 4DHXF63KE-FSD
 4DHXF63KE-TSE
 4DHXF63KE-TSK
 4DHXR22ME-FSD
 4DHXR22ME-TSE
 4DHXR22ME-TSK
 4DJXF76ME-FSD
 4DJXF76ME-TSE
 4DJXF76ME-TSK
 4DJXR28ME-FSD
 4DJXR28ME-TSE
 4DJXR28ME-TSK

6D

6DBXR32ME-TSK
 6DGXR37ME-TSE
 6DGXR37ME-TSN
 6DHXF93KE-TSE
 6DHXF93KE-TSK
 6DHXR35ME-TSE
 6DHXR35ME-TSK
 6DJXF11ME-TSE
 6DJXF11ME-TSK
 6DJXR40ME-TSE
 6DJXR40ME-TSN
 6DKXF93KE-TSE
 6DKXF93KE-TSK
 6DHXR35ME-TSK
 6DJXF11ME-TSE
 6DJXF11ME-TSK
 6DJXR40ME-TSE
 6DJXR40ME-TSN
 6DKXF93KE-TSE
 6DKXF93KE-TSK
 6DKXR35ME-TSE
 6DKXR35ME-TSK
 6DMXR37ME-TSE
 6DMXR37ME-TSN

ZBD

ZBD30KCE-TFD
 ZBD30KCE-TFE
 ZBD30KCE-TF5
 ZBD38KCE-PFV
 ZBD38KCE-TFD
 ZBD38KCE-TFE
 ZBD38KCE-TF5
 ZBD38KCE-TF7
 ZBD38KCP-TFD
 ZBD38KCP-TF5
 ZBD45KCE-TFD
 ZBD45KCE-TFE
 ZBD45KCE-TF5
 ZBD45KCE-TF7
 ZBD57KCE-TFD
 ZBD57KCE-TFE
 ZBD57KCE-TF5
 ZBD57KCE-TF7
 ZBD58KCE-TFD
 ZBD58KCE-TF5
 ZBD58KCE-TF7
 ZBD69KCP-TFD
 ZBD69KCP-TFE
 ZBD76KCE-TFD
 ZBD76KCE-TF5
 ZBD76KCE-TF7
 ZBD78KCP-TFD
 ZBD78KCP-TFE

ZFD

ZFD13KVE-TF5
 ZFD13KVE-TF7
 ZFD18KVE-TFD
 ZFD18KVE-TFE
 ZFD18KVE-TF5
 ZFD18KVE-TF7
 ZFD25KVE-TFD
 ZFD25KVE-TFE
 ZFD25KVE-TF5
 ZFD25KVE-TF7

ZPD

ZPD42K5E-TFD
 ZPD42K5E-TFE
 ZPD42K5E-TF5
 ZPD42K5E-TF7
 ZPD51K5E-PFZ
 ZPD51K5E-PFV
 ZPD51K5E-PFZ
 ZPD51K5E-TFD
 ZPD51K5E-TFE
 ZPD51K5E-TF5
 ZPD51K5E-TF7
 ZPD54K5E-PFZ
 ZPD54K5E-PFV
 ZPD54K5E-PFZ
 ZPD54K5E-TFD
 ZPD54K5E-TFE
 ZPD54K5E-TF5
 ZPD54K5E-TF7
 ZPD61KCE-TFE
 ZPD61KCE-TF0
 ZPD61KCE-TF5
 ZPD67KCE-PFZ
 ZPD72KCE-TF0
 ZPD83KCE-TFD
 ZPD83KCE-TFE
 ZPD83KCE-TF0
 ZPD83KCE-TF5
 ZPD83KCE-TF7
 ZPD91KCE-TFE
 ZPD91KCE-TF5
 ZPD91KCE-TF7

ZRD

ZRDU13MC-TF7
 ZRDU13MCE-TFD
 ZRDU13MCE-TF5
 ZRDU13MCE-TF7
 ZRD125KCE-TFD
 ZRD125KCE-TFE
 ZRD125KCE-TF5
 ZRD125KCE-TF7
 ZRD36KC-TF5
 ZRD36KCE-PFV
 ZRD36KCE-TF7
 ZRD42KCE-PFJ
 ZRD42KCE-TFD
 ZRD48KC-TFD
 ZRD48KCE-PFV
 ZRD48KCE-TF5
 ZRD48KCE-TF7
 ZRD49KCE-PFV
 ZRD49KCE-TF5
 ZRD49KCE-TF7
 ZRD61KCE-PFV
 ZRD61KCE-TFD
 ZRD61KCE-TFE
 ZRD61KCE-TF5
 ZRD61KCE-TF7
 ZRD72KCE-TF5
 ZRD72KCE-TF7
 ZRD94KCE-TFD
 ZRD94KCE-TFE
 ZRD94KCE-TF5
 ZRD94KCE-TF7

ZOD

ZOD104KCE-TFE
 ZOD104KCE-TF5
 ZOD104KCE-TF7
 ZOD34K3E-TFD
 ZOD34K3E-TFE
 ZOD34K3E-TF5
 ZOD34K3E-TF7

Emerson Approved Contactors

Emerson Part #	Description
912-1025-00	1 Pole, 25A Ind. 24v
912-1025-01	1 Pole, 25A Ind. 120v
912-1025-02	1 Pole, 25A Ind. 208/240v
912-1030-00	1 Pole, 30A Ind. 24v
912-1030-01	1 Pole, 30A Ind. 120v
912-1030-02	1 Pole, 30A Ind. 208/240v
912-1040-00	1 Pole, 40A Ind. 24v
912-1040-01	1 Pole, 40A Ind. 120v
912-1040-02	1 Pole, 40A Ind. 208/240v
912-1925-00	1 Pole, 25A Ind. 24v w/Shunt
912-1925-01	1 Pole, 25A Ind. 120v w/ Shunt
912-1925-02	1 Pole, 25A Ind. 208/240v w/ Shunt
912-1930-00	1 Pole, 30A Ind. 24v w/ Shunt
912-1930-01	1 Pole, 30A Ind. 120v w/ Shunt
912-1930-02	1 Pole, 30A Ind. 208/240v w/ Shunt
912-1940-00	1 Pole, 40A Ind. 24v w/ Shunt
912-1940-01	1 Pole, 40A Ind. 120v w/ Shunt
912-1940-02	1 Pole, 40A Ind. 208/240v w/ Shunt
912-2020-00	2 Pole, 20A Ind. 24v
912-2020-01	2 Pole, 20A Ind. 120v
912-2020-02	2 Pole, 20A Ind. 208/240v
912-2025-00	2 Pole, 25A Ind. 24v
912-2025-01	2 Pole, 25A Ind. 120v
912-2025-02	2 Pole, 25A Ind. 208/240v
912-2030-00	2 Pole, 30A Ind. 24v
912-2030-01	2 Pole, 30A Ind. 120v
912-2030-02	2 Pole, 30A Ind. 208/240v
912-2040-00	2 Pole, 40A Ind. 24v
912-2040-01	2 Pole, 40A Ind. 120v
912-2040-02	2 Pole, 40A Ind. 208/240v
912-3015-00	3 Pole, 15A Ind. 24v
912-3015-01	3 Pole, 15A Ind. 120v
912-3015-02	3 Pole, 15A Ind. 208/240v
912-3015-03	3 Pole, 15A Ind. 440v
912-3025-00	3 Pole, 25A Ind. 24v
912-3025-01	3 Pole, 25A Ind. 120v
912-3025-02	3 Pole, 25A Ind. 208/240v
912-3025-03	3 Pole, 25A Ind. 440v
912-3030-00	3 Pole, 30A Ind. 24v
912-3030-01	3 Pole, 30A Ind. 120v
912-3030-02	3 Pole, 30A Ind. 208/240v
912-3030-03	3 Pole, 30A Ind. 440v
912-3040-00	3 Pole, 40A Ind. 24v
912-3040-01	3 Pole, 40A Ind. 120v
912-3040-02	3 Pole, 40A Ind. 208/240v
912-3040-03	3 Pole, 40A Ind. 440v
912-3050-00	3 Pole, 50A Ind. 24v
912-3050-01	3 Pole, 50A Ind. 120v

Emerson Part #	Description
912-3050-02	3 Pole, 50A Ind. 208/240v
912-3050-03	3 Pole, 50A Ind. 440v
912-3060-00	3 Pole, 60A Ind. 24v
912-3060-01	3 Pole, 60A Ind. 120v
912-3060-02	3 Pole, 60A Ind. 208/240v
912-3060-03	3 Pole, 60A Ind. 440v
912-3075-00	3 Pole, 75A Ind. 24v
912-3075-01	3 Pole, 75A Ind. 120v
912-3075-02	3 Pole, 75A Ind. 208/240v
912-3075-03	3 Pole, 75A Ind. 440v
912-3090-04	3 Pole, 90A Ind. 24v
912-3090-05	3 Pole, 90A Ind. 120v
912-3090-06	3 Pole, 90A Ind. 208/240v
912-3090-07	3 Pole, 90A Ind. 440v
912-3120-00	3 Pole, 120A Ind. 24v
912-3120-01	3 Pole, 120A Ind. 120v
912-3120-02	3 Pole, 120A Ind. 208/240v
912-3120-03	3 Pole, 120A Ind. 440v
912-3200-00	3 Pole, 200A Ind. 24v
912-3200-01	3 Pole, 200A Ind. 120v
912-3200-02	3 Pole, 200A Ind. 208/240v
912-3200-03	3 Pole, 200A Ind. 440v
912-3300-00	3 Pole, 300A Ind. 24v
912-3300-01	3 Pole, 300A Ind. 120v
912-3300-02	3 Pole, 300A Ind. 208/240v
912-3300-03	3 Pole, 300A Ind. 440v
912-3360-00	3 Pole, 360A Ind. 24v
912-3360-01	3 Pole, 360A Ind. 120v
912-3360-02	3 Pole, 360A Ind. 208/240v
912-3360-03	3 Pole, 360A Ind. 440v

Auxilliary Contact Kits (Side Mounted)

912-0001-10	1 NO - For 15-75A
912-0001-11	1 NC - For 15-75A
912-0001-12	1 NO/1 NC - For 15-75A
912-0001-13	2 NO - For 15-75A
912-0001-14	2 NC - For 15-75A
912-0001-39	1 NO - For 90A
912-0001-40	1 NC - For 90A
912-0001-41	1 NO/1 NC - For 90A
912-0001-42	2 NO - For 90A
912-0001-19	1 NO - For 120-360A
912-0001-20	1 NC - For 120-360A
912-0001-21	1 NO/1 NC - For 120-360A
912-0001-22	Mech. Interlock - For 15-75A

For more information see Application Engineering bulletin AE10-1244.

EmersonClimate.com

The contents of this publication are presented for informational purposes only and are not to be construed as warranties or guarantees, express or implied, regarding the products or services described herein or their use or applicability. Emerson Climate Technologies, Inc. and/or its affiliates (collectively “Emerson”), as applicable, reserve the right to modify the design or specifications of such products at any time without notice. Emerson does not assume responsibility for the selection, use or maintenance of any product. Responsibility for proper selection, use and maintenance of any Emerson product remains solely with the purchaser or end user.

2014DS-78 R2 (2/16)

Emerson, Copeland Discus, Copeland Scroll and CoreSense are trademarks of Emerson Electric Co. or one of its affiliated companies. ©2016 Emerson Climate Technologies, Inc. All rights reserved.