

TECHNICAL GUIDE

LX SERIES

**DUCTLESS SINGLE-SPLIT
AIR CONDITIONERS AND HEAT PUMPS**
16 SEER – 1 PHASE
3/4 THRU 2 NOMINAL TONS
MODELS: DCMF/DHMF



Intertek

Due to continuous product improvement, specifications are subject to change without notice.

Visit us on the web at
www.upgnet.com

Additional rating information can be found at
www.ahridirectory.org

WARRANTY SUMMARY*

Standard 2-Years limited parts warranty.
Standard 6-Years limited compressor warranty.

DESCRIPTION

The Single-Split Series are ductless climate systems. They are designed with a matching indoor unit for optimum performance and efficiency. These climate systems are supported with accessories and documents to serve specific functions.

FEATURES

Variable Frequency Rotary Compressor - Twin rotary inverter compressor on all models features high efficiency operation that modulates down to 15 Hz and as high as 120 Hz for reduced vibration and quiet operation. Brushless DC motor uses powerful Neodymium magnets that are approximately 15-20 times stronger than ferrite magnets used in conventional AC compressors. The DC Inverter Control provides continuous operation, while adjusting capacity according to room temperature. The accurate sensing of cooling or heating loads prevents frequent changes in capacity and ensures efficient, economical operation.

Low Ambient Cooling Operation Down to 5 °F - This feature allows for a space to be air-conditioned even in outdoor temperatures as low as 5 °F. This cooling ability is important when dealing with server equipment rooms, surveillance mechanical rooms, restaurant kitchens, fitness centers, and more.

Load Variation Management System - The outdoor coil thermistor continuously monitors the temperature and communicates with the microprocessor. Depending on the temperature measured, the compressor will be allowed to increase the frequency if needed to meet the load or reduce frequency as the load is reduced.

High Pressure Discharge Temperature - The compressor discharge line thermistor continuously monitors the temperature and communicates with the microprocessor. Depending on the temperature measured, the compressor will be allowed to increase the frequency to meet the load or is forced to run at the current or reduced frequency. If the temperature gets excessively high, the compressor will be de-energized.

Defrost Control (Heat Pump Models) - Defrost cycle is automatically enabled if there is a build-up of frost on the outdoor coil. Outdoor fan and indoor blower operation is terminated during the defrost cycle. H1 is displayed on the indoor unit panel on the front cover during a defrost cycle.

Reversing Valve (Heat Pump Models) - 4-way interchange reversing valve effects a rapid change in direction of refrigerant flow resulting in quick changeover from cooling to heating and vice versa. Valve operates on system pressure differential between outdoor unit and indoor unit.

R-410A Refrigerant - Unit is pre-charged with R410A refrigerant that uses PVE refrigerant oil. Polyvinyl ether (PVE) is an innovative refrigerant oil specially formulated for hydrofluorocarbon (HFC) refrigeration systems. In addition to providing lubricating properties, it also has a number of other applied advantages that help to increase the reliability of the refrigeration systems where it is applied.

Refrigerant Line Connections, Service Valve - Outdoor units are designed with easy service and maintenance in mind. Maintenance points are located behind easy-access panels, to make installation and service a breeze for a trained technician. Flare connection lines are located on side of unit cabinet. Fully serviceable brass service valve prevents corrosion and provide access to refrigerant system. Shut-off valve that can be fully shut off while 2-way suction/vapor valve (with service port) may be front seated to manage refrigerant charge while servicing system.

Air Deflection Louvers - Horizontal louvers default to the cooling or heating position when the unit is operating. Horizontal louvers can be set to a preset oscillating range or fixed position from the wireless remote control. Full oscillating is the default setting when button is pushed. Vertical louvers can be manually adjusted to direct the airflow for optimal comfort.

Indoor Coil Freeze Protection - The indoor coil thermistor monitors the coil temperature continuously. Any time the coil temperature drops below 30°F, the compressor and the outdoor fan (30 seconds later) will be switched off until the coil temperature rises above 43°F and the compressor has been off for a minimum of 3 minutes.

I FEEL Function - When I FEEL is activated, the system will satisfy the cooling or heating temperature setpoint where the remote control is located. When I FEEL is deactivated, the system will satisfy the cooling or heating temperature setpoint where the indoor unit is located. This feature provides homeowners with optimum comfort whether they are near or far from the indoor unit.

Hot Heat Pump (cold air prevention) - In heating mode, the indoor fan will be delayed from 1 to 3 minutes to allow refrigerant to warm up and avoid cold blow. This may occur during:

- Initial start-up of a heating cycle
- Immediately after completion of an Auto mode operation
- Heating under extremely low indoor temperatures

Nomenclature

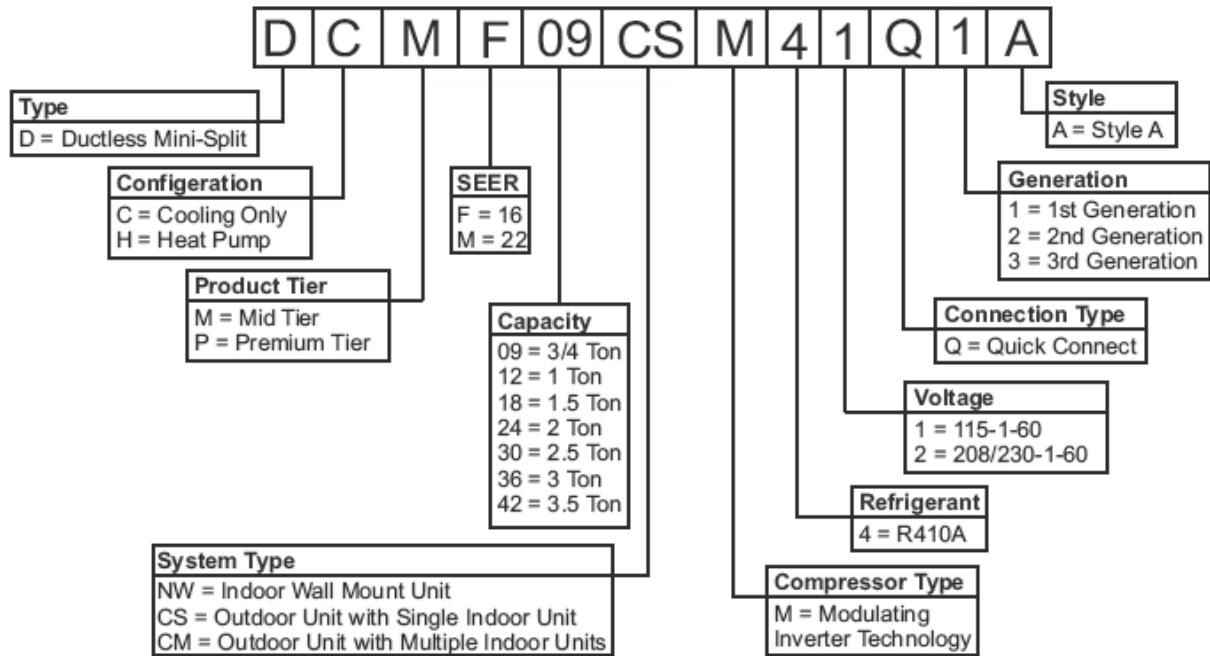

SPECIFICATIONS

AIR CONDITIONERS					
Model (Indoor/Outdoor)	DCMF09NWM42Q1	DCMF12NWM42Q1	DCMF18NWM42Q1	DCMF24NWM42Q1	
	DCMF09CSM42Q1	DCMF12CSM42Q1	DCMF18CSM42Q1	DCMF24CSM42Q1	
Function	Cooling	Cooling	Cooling	Cooling	
Rated Voltage	208/230	208/230	208/230	208/230	
Frequency (Hz)	60Hz	60Hz	60Hz	60Hz	
Total Capacity (BTUH) (High/Standard/Low)	11500/9000/3800	12500/12000/3300	21000/18000/4500	24000/22000/6400	
Total Capacity (W) (High/Standard/Low)	3370/2637/1114	3663/3516/967	6155/5276/1319	7032/6446/1875	
Rated Power Input (W)	882	1224	1621	2200	
Nominal Input Current (A)	4.01	5.56	7.37	10.00	
SEER	16.00	16.00	16.00	16.00	
Air Flow Volume (CFM) (H/M/L)	330/300/260/210	340/300/260/210	470/400/330/270	590/440/300/200	
Air Flow Volume (m ³ /h) (H/M/L)	560/510/440/370	580/520/440/370	800/680/560/460	1000/750/520/350	
Dehumidifying Volume (cu.ft./h)	0.028	0.049	0.064	0.075	
Dehumidifying Volume (l/h)	0.80	1.40	1.80	2.13	
EER	10.2	9.8	11.1	10	
Indoor Unit	Model of Indoor Unit	DCMF09NWM42Q1	DCMF12NWM42Q1	DCMF18NWM42Q1	DCMF24NWM42Q1
	Fan Motor Speed (r/min) (SH/H/M/L)	1300/1100/900/700	1350/1150/950/750	1400/1150/1000/850	1450/1180/1000/850
	Output of Fan Motor (w)	15	15	20	36
	Fan Motor Capacitor (uF)	1.2	1.2	1.5	2.5
	Fan Motor RLA (A)	0.19	0.19	0.32	0.45
	Fan Type-Piece	Cross-flow - 1	Cross-flow - 1	Cross-flow - 1	Cross-flow - 1
	Diameter-Length (inch)	3.6 x 23.4	3.6 x 23.4	3.9 x 25.6	3.9 x 30.1
	Diameter-Length (mm)	92 x 594	92 x 595	98 x 650	98 x 765
	Evaporator	Aluminum Fin-copper Tube	Aluminum Fin-copper Tube	Aluminum Fin-copper Tube	Aluminum Fin-copper Tube
	Pipe Diameter (inch)	Φ 0.276	Φ 0.276	Φ 0.276	Φ 0.276
	Pipe Diameter (mm)	φ7	φ7	φ7	φ7
	Row-Fin Gap (inch)	2 - 0.055	2 - 0.055	2 - 0.055	2 - 0.059
	Row-Fin Gap (mm)	2-1.4	2-1.4	2-1.4	2-1.5
	Coil length (L) x height (H) x coil width (W) (inch)	24.0 x 11.6 x 0.9	24.0 x 11.6 x 0.9	25.9 x 12.0 x 1.0	30.1 x 13.5 x 1.0
	Coil length (L) x height (H) x coil width (W) (mm)	610 x 24 x 294	610 x 24 x 294	657 x 25.4 x 304.8	765 x 25.4 x 342.9
	Output of Swing Motor (W)	1.5	1.5	2	3
	Fuse (A)	3.15	3.15	3.15	3.15
	Sound Pressure Level dB (A)(SH/H/M/L)	43 / 38 / 32 / 26	44 / 39 / 33 / 28	48 / 43 / 38 / 34	49 / 43 / 39 / 34
	Sound Power Level dB (A)(SH/H/M/L)	53 / 48 / 42 / 36	54 / 49 / 43 / 38	58 / 53 / 48 / 43	59 / 53 / 49 / 44
	Dimension (W/D/H) (inch)	30.3 x 7.9 x 11.1	30.3 x 7.9 x 11.1	34.1 x 8.5 x 12.0	39.7 x 8.7 x 12.4
	Dimension (W/D/H) (mm)	770 x 201 x 282	770 x 201 x 282	865 x 216 x 305	1008 x 221 x 315
	Dimension of Package (L/W/H) (inch)	33.3 x 10.9 x 13.9	33.3 x 10.9 x 13.9	37.3 x 12.2 x 15.1	42.2 x 12.3 x 15.6
	Dimension of Package (L/W/H) (mm)	847 x 276 x 352	847 x 276 x 352	948 x 310 x 383	1073 x 313 x 395
Net Weight /Gross Weight (lbs)	19 / 25	20 / 27	27 / 35	33.0 / 44.0	
Net Weight /Gross Weight (kg)	8.6 / 11.5	9.0 / 12	12.0 / 16	15 / 20	

Continued on next page.

AIR CONDITIONERS (Continued)					
	Model of Outdoor Unit	DCMF09CSM42Q1	DCMF12CSM42Q1	DCMF18CSM42Q1	DCMF24CSM42Q1
Outdoor Unit	Compressor Manufacturer/trademark	GREE	GREE	MITSUBISHI	SANYO
	Compressor Type	Inverter Rotary	Inverter Rotary	Inverter Rotary	Inverter Rotary
	L.R.A. (A)	16.50	16.50	27	41
	Compressor RLA (A)	6.22	6.22	10.86	11.38
	Compressor Power Input (W)	950	950	1245	1630
	Throttling Method	Capillary	Capillary	Capillary	EXV
	Working Temp Range (°F)	5 ~ 115	5 ~ 115	5 ~ 115	5 ~ 115
	Working Temp Range (°C)	-15 ~ 46	-15 ~ 46	-15 ~ 46	-15 ~ 46
	Condenser	Aluminum Fin-copper Tube	Aluminum Fin-copper Tube	Aluminum Fin-copper Tube	Aluminum Fin-copper Tube
	Pipe Diameter (inch)	Φ 0.276	Φ 0.276	Φ 0.276	Φ 0.276
	Pipe Diameter (mm)	φ7	φ7	φ7	φ7
	Rows-Fin Gap (inch)	1 - 0.055	2 - 0.055	2 - 0.055	2 - 0.055
	Rows-Fin Gap (mm)	1-1.4	2-1.4	2-1.4	2-1.4
	Coil length (L) x height (H) x coil width (L) (inch)	25.5 x 20.8 x 0.8	25.5 x 20.8 x 1.5	33.0 x 26.0 x 1.5	33.6 x 26.0 x 1.5
	Coil length (L) x height (H) x coil width (L) (mm)	647 x 19.05 x 528	647 x 38.1 x 528	837 x 38.1 x 660	853 x 38.1 x 660
	Fan Motor Speed (rpm)	880±20	880±20	690	690
	Output of Fan Motor (W)	21	21	60	60
	Fan Motor RLA (A)	0.25	0.25	0.62	0.62
	Fan Motor Capacitor (uF)	2	2	3	3.5
	Fuse (A)	15A	15A	25A	25A
	Air Flow Volume of Outdoor Unit (CFM)	944	944	1887	1887
	Air Flow Volume of Outdoor Unit (m ³ /h)	1600	1600	3200	3200
	Fan Type-Piece	Axial-flow-1	Axial-flow-1	Axial-flow-1	Axial-flow-1
	Fan Diameter (inch)	14.6	14.6	20.5	20.5
	Fan Diameter (mm)	370	370	520	520
	Defrosting Method	Automatic Defrosting	Automatic Defrosting	Automatic Defrosting	Automatic Defrosting
	Climate Type	T1	T1	T1	T1
	Permissible Excessive Operating Pressure for the Discharge Side (PSI)	624	624	624	624
	Permissible Excessive Operating Pressure for the Discharge Side (MPa)	4.3	4.3	4.3	4.3
	Permissible Excessive Operating Pressure for the Suction Side (PSI)	363	363	363	363
	Permissible Excessive Operating Pressure for the Suction Side (MPa)	2.5	2.5	2.5	2.5
	Sound Pressure Level dB (A)	49	52	56	56
	Sound Power Level dB (A)	59	62	66	66
Dimension (W/D/H) (mm)	28.0 x 12.5 x 21.7	28.0 x 12.5 x 21.7	37.9 x 15.6 x 27.6	37.9 x 15.6 x 27.6	
Dimension (W/D/H) (mm)	711 x 318 x 551	711 x 318 x 551	963 x 396 x 701	963 x 396 x 701	
Dimension of Package (L/W/H) (inch)	30.4 x 13.7 x 23.3	30.4 x 13.7 x 23.3	40.4 x 17.9 x 28.9	40.4 x 17.9 x 28.9	
Dimension of Package (L/W/H) (mm)	771 x 348 x 592	771 x 348 x 592	1026 x 455 x 735	1026 x 455 x 735	
Net Weight /Gross Weight (lbs)	64 / 73	68 / 77	104 / 115	112 / 123	
Net Weight /Gross Weight (kg)	29 / 33	31 / 35	47 / 52	51 / 56	
Refrigerant Charge (oz)	26.1	35.3	44.1	54.7	
Refrigerant Charge (kg)	0.74	1.00	1.25	1.55	
MCA	10.0	10.0	15.0	16.0	
MOP	15.0	15.0	25.0	25.0	
Connection Pipe	Length (ft)	25	25	25	25
	Length (m)	7.5	7.5	7.5	7.5
	Gas additional charge (oz/ft)	0.2	0.2	0.2	0.2
	Gas additional charge (g/m)	15	15	15	15
	Outer Diameter Liquid Pipe (inch)	Φ 1/4	Φ 1/4	Φ 1/4	Φ 1/4
	Outer Diameter Liquid Pipe (mm)	φ6	φ6	φ6	φ6
	Outer Diameter Gas Pipe (inch)	Φ 3/8	Φ 3/8	Φ 1/2	Φ 1/2
	Outer Diameter Gas Pipe (mm)	φ9.52	φ9.52	φ12	φ12
	Max Height Distance (ft)	32.8	32.8	32.8	32.8
	Max Height Distance (m)	9.9	9.9	9.9	9.9
Max Length Distance (ft)	49.2	49.2	82	82	
Max Length Distance (m)	14.9	14.9	24.9	24.9	

HEAT PUMPS										
Model (Indoor/Outdoor)	DHMF09NWM42Q1		DHMF12NWM42Q1		DHMF18NWM42Q1		DHMF24NWM42Q1			
	DHMF09CSM42Q1		DHMF12CSM42Q1		DHMF18CSM42Q1		DHMF24CSM42Q1			
Function	Cooling	Heating	Cooling	Heating	Cooling	Heating	Cooling	Heating		
Rated Voltage	208/230		208/230		208/230		208/230			
Frequency (Hz)	60Hz		60Hz		60Hz		60Hz			
Total Capacity (Btu/h) (High/Standard/Low)	11500/9000/ 3800	11500/9000/ 3300	12500/12000/ 3300	12500/12000/ 3400	21000/18000/ 4500	23000/19200/ 4000	24000/22000/ 6400	26600/26600/ 4100		
Total Capacity (W) (High/Standard/Low)	3370/2637/ 1114	3370/2637/ 967	3663/3516/ 967	3663/3516/ 996	6155/5276/ 1319	6741/5276/ 1172	7032/6446/ 1875	7796/6446/ 1202		
Rated Power Input (W)	882	799	1224	1065	1621	2123	2200	3118		
Nominal Input Current (A)	4.01	3.63	5.56	4.84	7.37	9.65	10.00	14.17		
SEER/HSPF	16.00	8.5	16.00	8.5	16.00	8	16	9.5		
Air Flow Volume (CFM) (H/M/L)	330/300/260/210	330	340/300/260/210	341	470/400/330/270		590/440/300/200			
Air Flow Volume (m ³ /h) (H/M/L)	560/510/440/370		580/520/440/370	580	800/680/560/460		1000/750/520/350			
Dehumidifying Volume (cu.ft./h)	0.028		0.049		0.064		0.075			
Dehumidifying Volume (l/h)	0.80		1.40		1.80		2.13			
EER / C.O.P	10.2	3.32	9.8	3.3	11.1	2.65	10	2.5		
Indoor Unit	Model of Indoor Unit		DHMF09NWM42Q1		DHMF12NWM42Q1		DHMF18NWM42Q1		DHMF24NWM42Q1	
	Fan Motor Speed (r/min) (SH/H/M/L)	1300/1100/ 900/700	1300/1150/ 980/820	1350/1150/ 950/750	1350/1190/ 1020/850	1400/1150/ 1000/850	1450/1250/ 1100/950	1400/1180/ 1000/850	1450/1380/ 1200/1150	
	Output of Fan Motor (w)	15		15		20		36		
	Fan Motor Capacitor (uF)	1.2		1.2		1.5		2.5		
	Fan Motor RLA(A)	0.19		0.19		0.32		0.45		
	Fan Type-Piece	Cross-flow - 1		Cross-flow - 1		Cross-flow - 1		Cross-flow - 1		
	Diameter-Length (inch)	3.6 x 23.4		3.6 x 23.4		3.9 x 25.6		3.9 x 30.1		
	Diameter-Length (mm)	92 x 594		92 x 595		98 x 650		98 x 765		
	Evaporator	Aluminum Fin-copper Tube		Aluminum Fin-copper Tube		Aluminum Fin-copper Tube		Aluminum Fin-copper Tube		
	Pipe Diameter (inch)	Φ 0.276		Φ 0.276		Φ 0.276		Φ 0.276		
	Pipe Diameter (mm)	φ7		φ7		φ7		φ7		
	Row-Fin Gap (inch)	2 - 0.055		2 - 0.055		2 - 0.055		2 - 0.059		
	Row-Fin Gap (mm)	2-1.4		2-1.4		2-1.4		2-1.5		
	Coil length (L) x height (H) x coil width (W) (inch)	24.0 x 11.6 x 0.9		24.0 x 11.6 x 0.9		25.9 x 12.0 x 1.0		30.1 x 13.5 x 1.0		
	Coil length (L) x height (H) x coil width (W) (mm)	610 x 24 x 294		610 x 24 x 294		657 x 25.4 x 304.8		765 x 25.4 x 342.9		
	Output of Swing Motor (W)	1.5		1.5		2		3		
	Fuse (A)	3.15		3.15		3.15		3.15		
	Sound Pressure Level dB (A) (SH/H/M/L)	43 / 38 / 32 / 26		44 / 39 / 33 / 28		48 / 43 / 38 / 34		49 / 43 / 39 / 34		
	Sound Power Level dB (A)(SH/H/M/L)	53 / 48 / 42 / 36		54 / 49 / 43 / 38		58 / 53 / 48 / 43		59 / 53 / 49 / 44		
	Dimension (W/D/H) (inch)	30.3 x 7.9 x 11.1		30.3 x 7.9 x 11.1		34.1 x 8.5 x 12.0		39.7 x 8.7 x 12.4		
Dimension (W/D/H) (mm)	770 x 201 x 283		770 x 201 x 283		865 x 215 x 305		1008 x 221 x 315			
Dimension of Package (L/W/H) (inch)	33.3 x 10.9 x 13.9		33.3 x 10.9 x 13.9		37.3 x 12.2 x 15.1		42.2 x 12.3 x 15.6			
Dimension of Package (L/W/H) (mm)	847 x 276 x 352		847 x 276 x 352		948 x 310 x 383		1073 x 313 x 395			
Net Weight /Gross Weight (lbs)	19 / 25		20 / 27		27 / 35		33.0 / 44.0			
Net Weight /Gross Weight (kg)	8.6 / 11.5		9.0 / 12.0		12.0 / 16.0		15 / 20			

Continued on next page.

HEAT PUMPS (Continued)									
Outdoor Unit	Model of Outdoor Unit	DHMF09CSM42Q1		DHMF12CSM42Q1		DHMF18CSM42Q1		DHMF24CSM42Q1	
	Compressor Manufacturer/trademark	GREE		GREE		MITSUBISHI		SANYO	
	Compressor Type	Inverter Rotary		Inverter Rotary		Inverter Rotary		Inverter Rotary	
	L.R.A. (A)	16.50		16.50		27		41	
	Compressor RLA(A)	6.22		6.22		10.86		11.38	
	Compressor Power Input (W)	950		950		1245		1630	
	Throttling Method	Capillary		Capillary		Capillary		EXV	
	Working Temp Range (°F)	5 ~ 115	14 ~ 75	5 ~ 115	14 ~ 75	5 ~ 115	14 ~ 75	5 ~ 115	14 ~ 75
	Working Temp Range (°C)	-15 ~ 46	-10 ~ 24	-15 ~ 46	-10 ~ 24	-15 ~ 46	-10 ~ 24	-15 ~ 46	-10 ~ 24
	Condenser	Aluminum Fin-copper Tube		Aluminum Fin-copper Tube		Aluminum Fin-copper Tube		Aluminum Fin-copper Tube	
	Pipe Diameter (inch)	Φ 0.276		Φ 0.276		Φ 0.276		Φ 0.276	
	Pipe Diameter (mm)	φ7		φ7		φ7		φ7	
	Rows-Fin Gap (inch)	1 - 0.055		2 - 0.055		2 - 0.055		2 - 0.055	
	Rows-Fin Gap (mm)	1-1.4		2-1.4		2-1.4		2-1.4	
	Coil length (l) x height (H) x coil width (L) (inch)	25.5 x 20.8 x 0.8		25.5 x 20.8 x 1.5		33.0 x 26.0 x 1.5		33.6 x 26.0 x 1.5	
	Coil length (l) x height (H) x coil width (L) (mm)	647 x 19.05 x 528		647 x 38.1 x 528		837 x 38.1 x 660		853 x 38.1 x 660	
	Fan Motor Speed (rpm)	880±20		880±20		690		690	
	Output of Fan Motor (W)	21		21		60		60	
	Fan Motor RLA(A)	0.25		0.25		0.62		0.62	
	Fan Motor Capacitor (uF)	2		2		3		3.5	
	Fuse (A)	15A		15A		25A		25A	
	Air Flow Volume of Outdoor Unit (CFM)	944		944		1887		1887	
	Air Flow Volume of Outdoor Unit (m³/h)	1600		1600		3200		3200	
	Fan Type-Piece	Axial-flow-1		Axial-flow-1		Axial-flow-1		Axial-flow-1	
	Fan Diameter (inch)	14.6		14.6		20.5		20.5	
	Fan Diameter (mm)	370		370		520		520	
	Defrosting Method	Automatic Defrosting		Automatic Defrosting		Automatic Defrosting		Automatic Defrosting	
	Climate Type	T1		T1		T1		T1	
	Permissible Excessive Operating Pressure for the Discharge Side (PSI)	624		624		624		624	
	Permissible Excessive Operating Pressure for the Discharge Side (MPa)	4.3		4.3		4.3		4.3	
	Permissible Excessive Operating Pressure for the Suction Side (PSI)	363		363		363		363	
	Permissible Excessive Operating Pressure for the Suction Side (MPa)	2.5		2.5		2.5		2.5	
	Sound Pressure Level dB (A)	49		52		56		56	
	Sound Power Level dB (A)	59		62		66		56	
	Dimension (W/D/H) (mm)	28.0 x 12.5 x 21.7		28.0 x 12.5 x 21.7		37.9 x 15.6 x 27.6		37.9 x 15.6 x 27.6	
	Dimension (W/D/H) (mm)	711 x 318 x 551		711 x 318 x 551		963 x 396 x 701		963 x 396 x 701	
	Dimension of Package (L/W/H) (inch)	30.4 x 13.7 x 23.3		30.4 x 13.7 x 23.3		40.4 x 17.9 x 28.9		40.4 x 17.9 x 28.9	
	Dimension of Package (L/W/H) (mm)	771 x 348 x 592		771 x 348 x 592		1026 x 455 x 735		1026 x 455 x 735	
	Net Weight /Gross Weight (lbs)	64 / 73		68 / 77		106 / 117		115 / 126	
	Net Weight /Gross Weight (kg)	29 / 33		31 / 35		48 / 53		52 / 57	
Refrigerant Charge (oz)	26.1		35.3		44.1		54.7		
Refrigerant Charge (kg)	0.74		1.00		1.25		1.55		
MCA	10.0		10.0		15.0		16.0		
MOP	15.0		15.0		25.0		25.0		
Connection Pipe	Length (ft)	25		25		25		25	
	Length (m)	7.5		7.5		7.5		7.5	
	Gas additional charge (oz/ft)	0.2		0.2		0.2		0.2	
	Gas additional charge (g/m)	20		20		20		20	
	Outer Diameter Liquid Pipe (inch)	Φ 1/4		Φ 1/4		Φ 1/4		Φ 1/4	
	Outer Diameter Liquid Pipe (mm)	φ6		φ6		φ6		φ6	
	Outer Diameter Gas Pipe (inch)	Φ 3/8		Φ 3/8		Φ 1/2		Φ 1/2	
	Outer Diameter Gas Pipe (mm)	φ9.52		φ9.52		φ12		φ12	
	Max Height Distance (ft)	32.8		32.8		32.8		32.8	
	Max Height Distance (m)	9.9		9.9		9.9		9.9	
Max Length Distance (ft)	49.2		49.2		82		82		
Max Length Distance (m)	14.9		14.9		24.9		24.9		

PRODUCT OPERATION CHARACTERISTIC CURVES

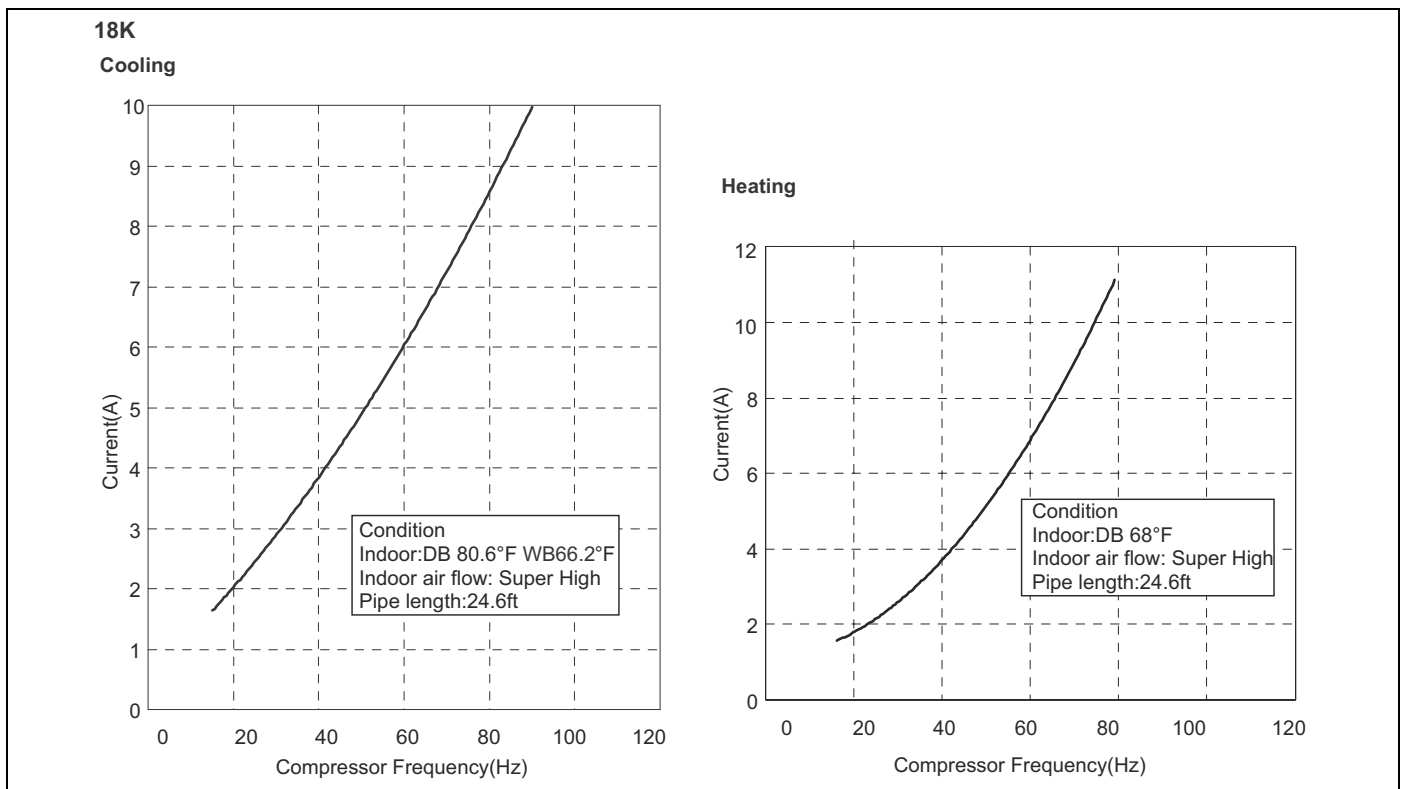
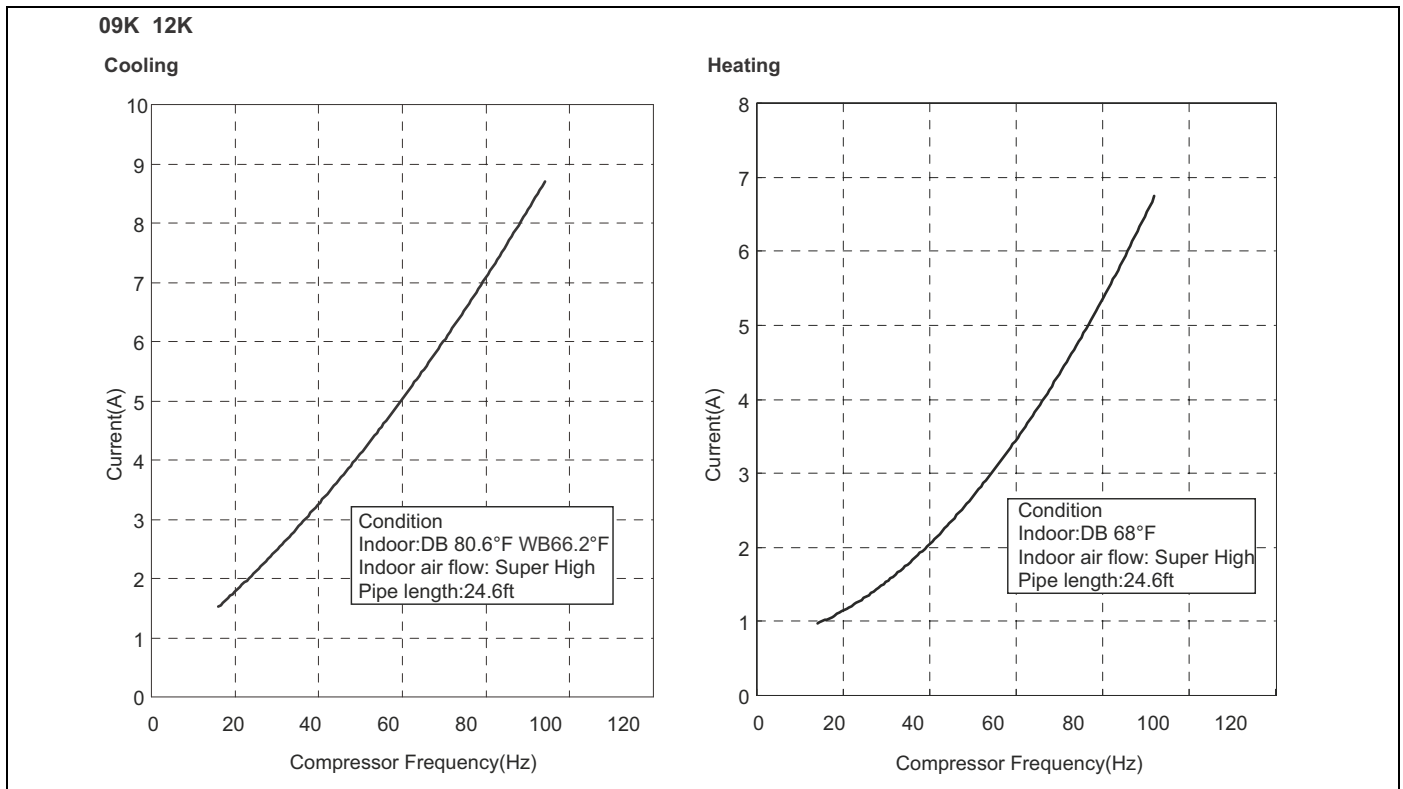

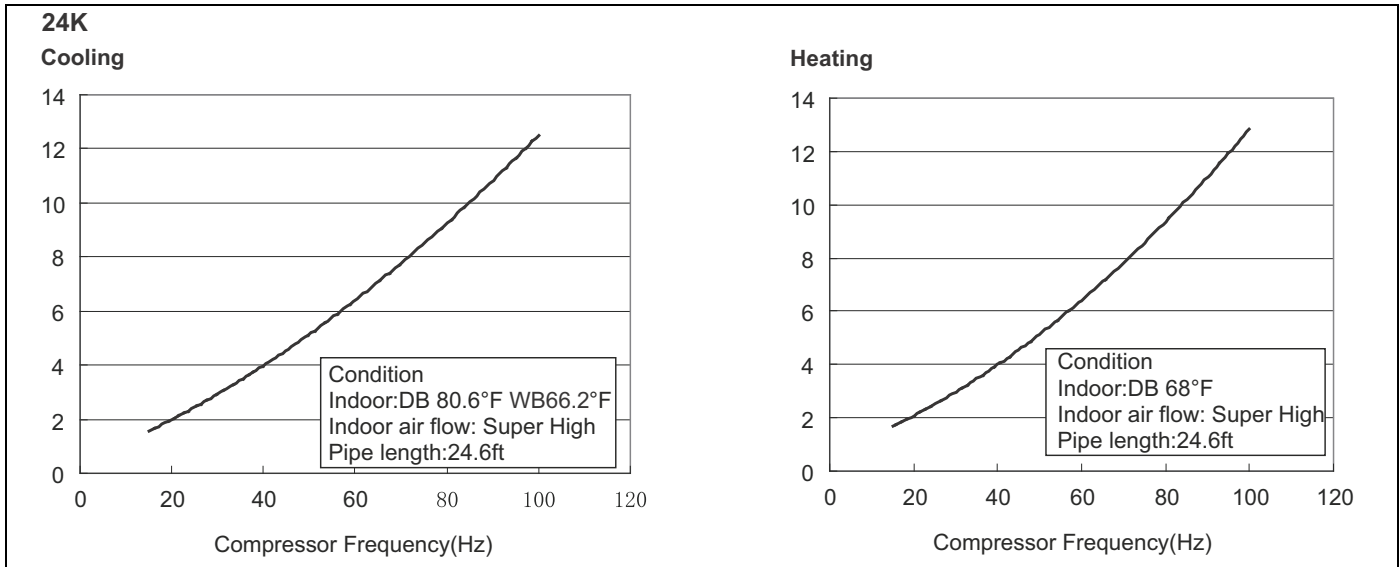

PRODUCT CAPACITY VARIATION RATIO

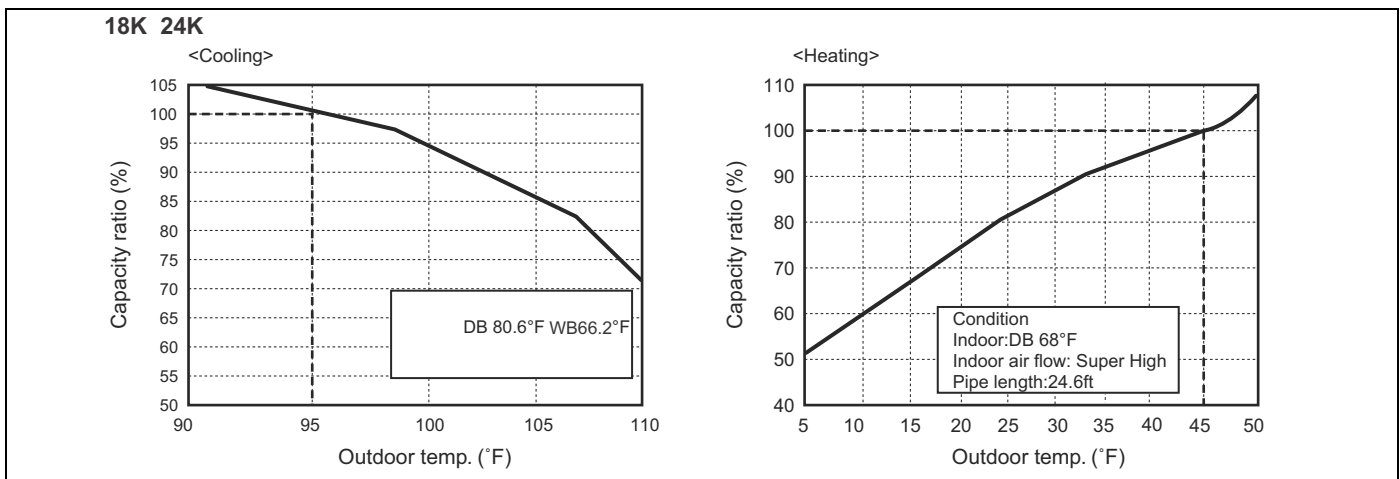
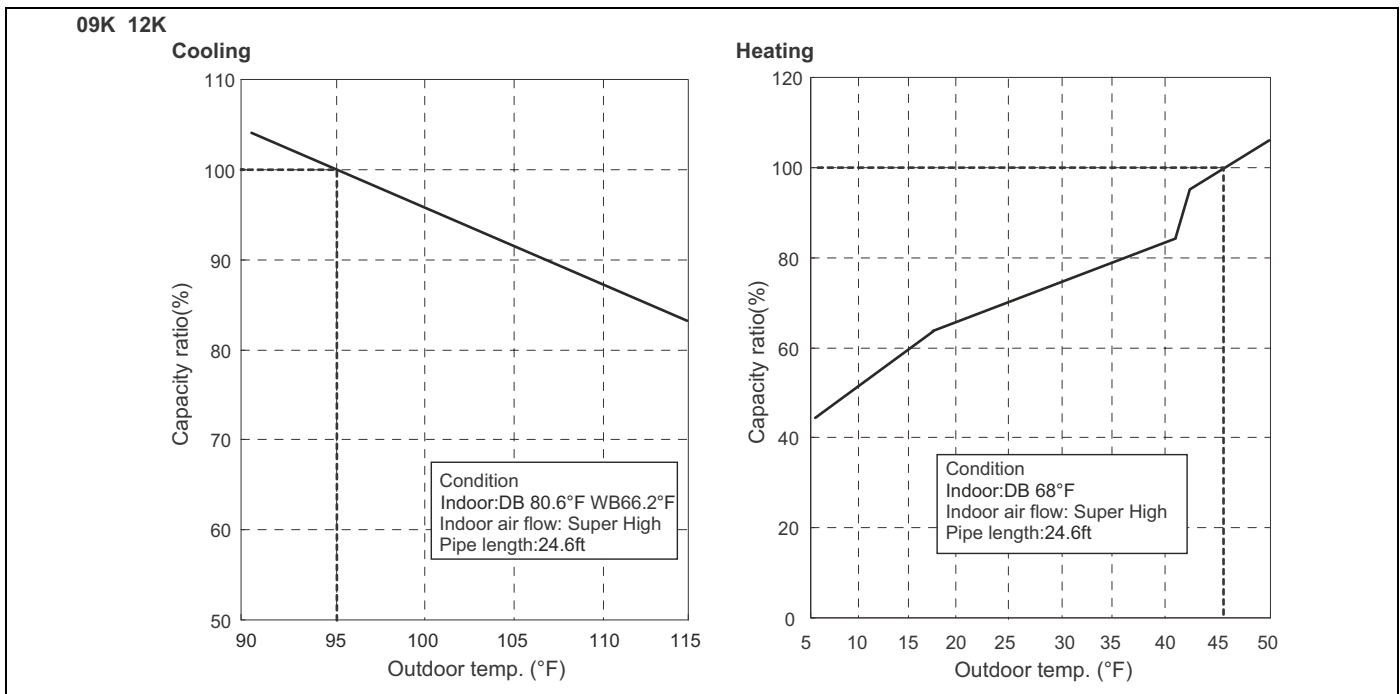

OPERATION DATA

Temperature Condition (°F)		Model name	Standard Pressure P (MPa)	Heat Exchanger Pipe Temperature		Indoor Fan Mode	Outdoor Fan Mode	Compressor Frequency (Hz)
Indoor	Outdoor			T1 (°F)	T2 (°F)			
COOLING								
80/66.9	95/75	09K	0.9 to 1.1	53.6 to 57.2	158 to 104	Super High	High	73
80/66.9	95/75	12K	0.9 to 1.1	53.6 to 57.2	158 to 104	Super High	High	71
80/66.9	95/75	18K	0.9 to 1.1	53.6 to 57.2	176 to 104	Super High	High	75
80/66.9	95/75	24K	0.9 to 1.1	53.6 to 57.2	176 to 104	Super High	High	89
HEATING								
70/60	46.9/43	09K	2.5 to 2.7	158 to 95	35.6 to 39.2	Super High	High	76
70/60	46.9/43	12K	2.5 to 2.7	158 to 95	35.6 to 39.2	Super High	High	76
70/60	46.9/43	18K	2.2 to 2.4	158 to 104	33.8 to 41.0	Super High	High	90
70/60	46.9/43	24K	2.2 to 2.4	158 to 104	33.8 to 41.0	Super High	High	87

Notes:

Measure surface temperature of heat exchanger pipe around center of heat exchanger path U bent. (Thermistor thermometer).

Connecting piping condition: 24.6 ft.

P: pressure of air pipe connected to the indoor and outdoor units (gas valve side),

T1: Inlet and outlet temperature for evaporator,

T2: Inlet and outlet temperature for condenser.

SOUND DATA

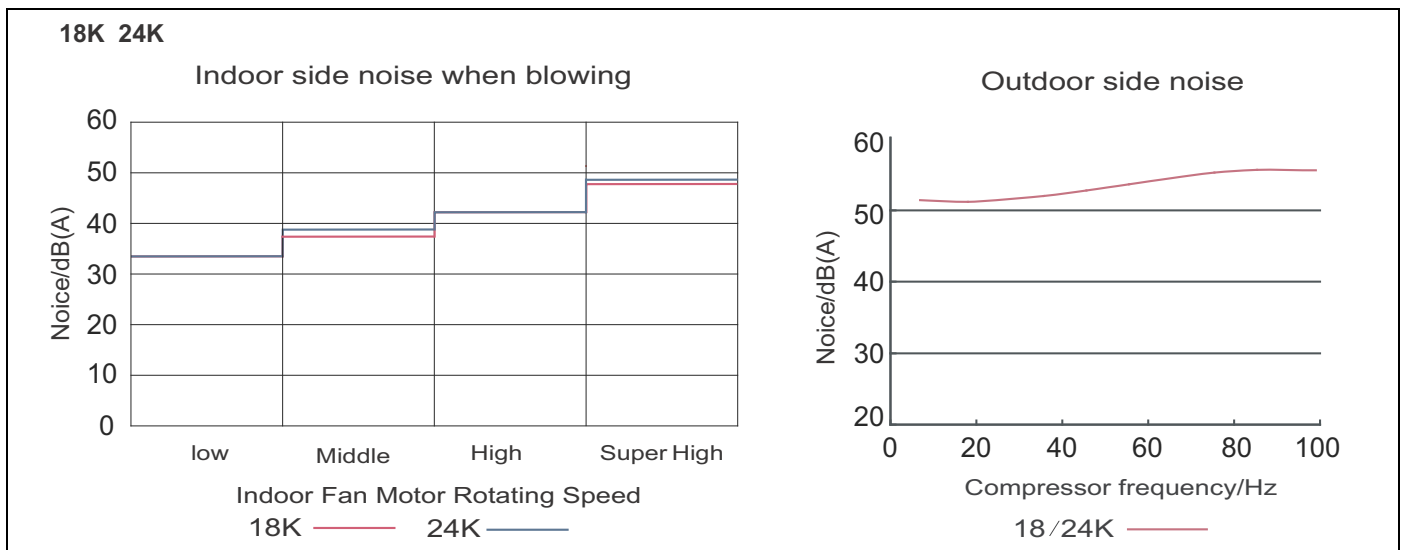
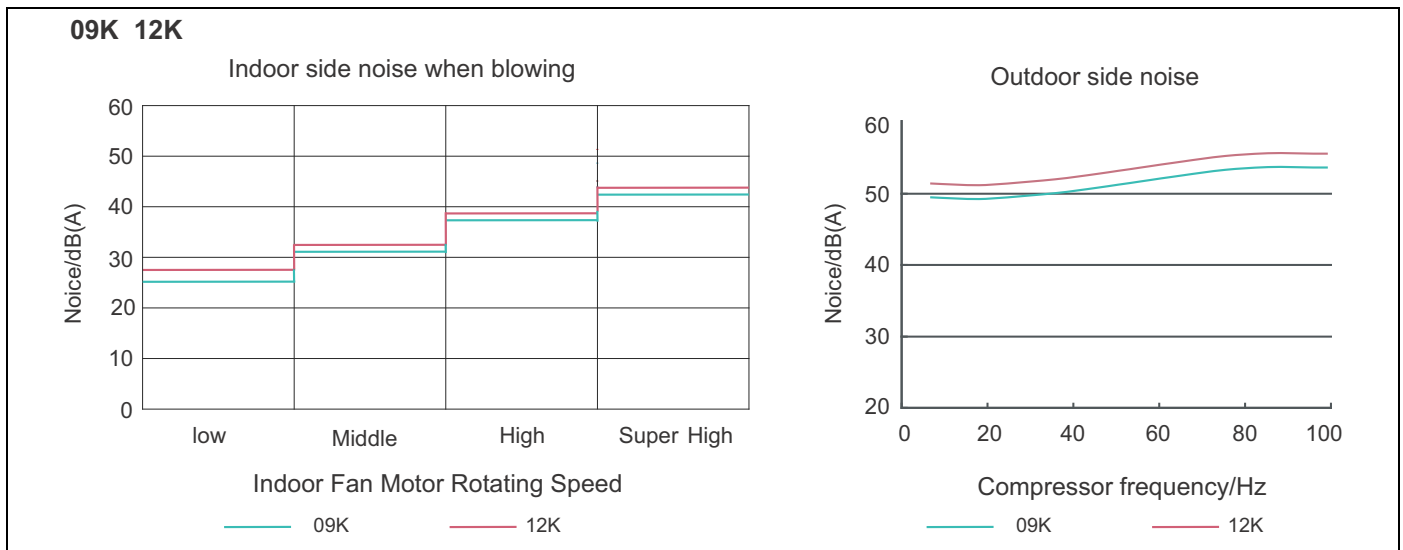

PRODUCT CONSTRUCTION VIEW & DIMENSIONS

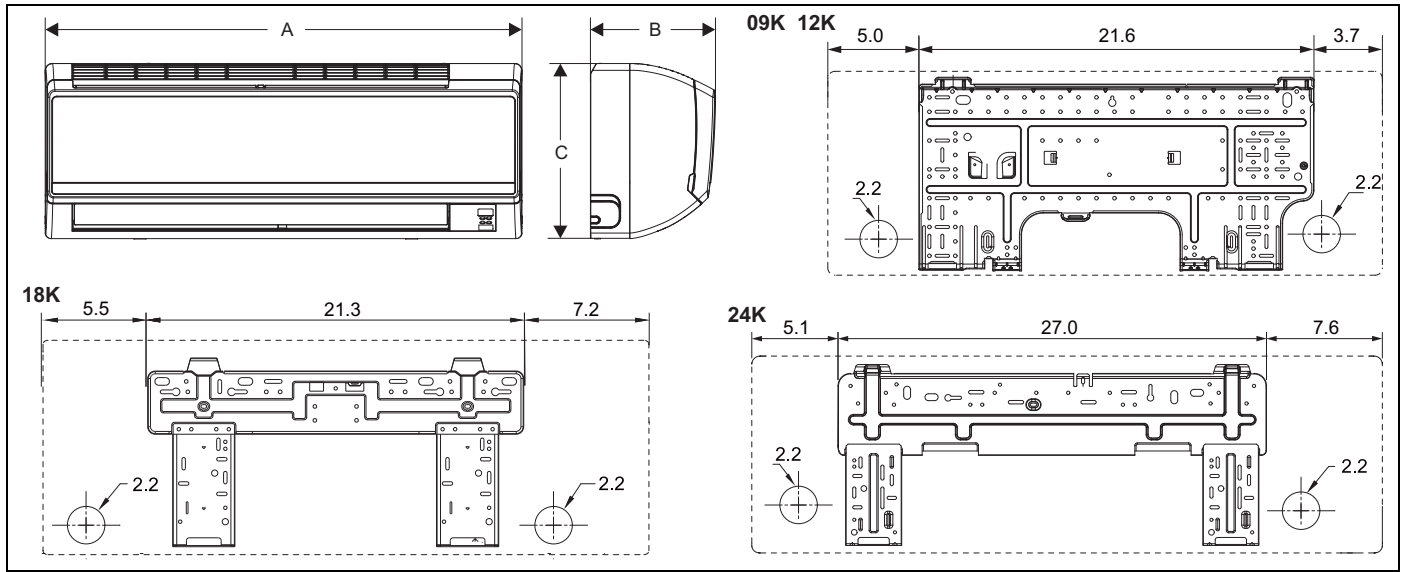

Indoor Unit Dimensions

Model Size	A	B	C	Unit Gross Weight	
				Air Conditioner	Heat Pump
09K	30.3 (770)	7.9 (201)	11.1 (282)	25 lbs (11.5 kg)	25 lbs (11.5 kg)
12K				27 lbs (12 kg)	27 lbs (12 kg)
18K	34.1 (866)	8.5 (216)	12.0 (305)	35 lbs (16 kg)	35 lbs (16 kg)
24K	39.7 (1008)	8.7 (221)	12.4 (315)	44 lbs (20 kg)	44 lbs (20 kg)

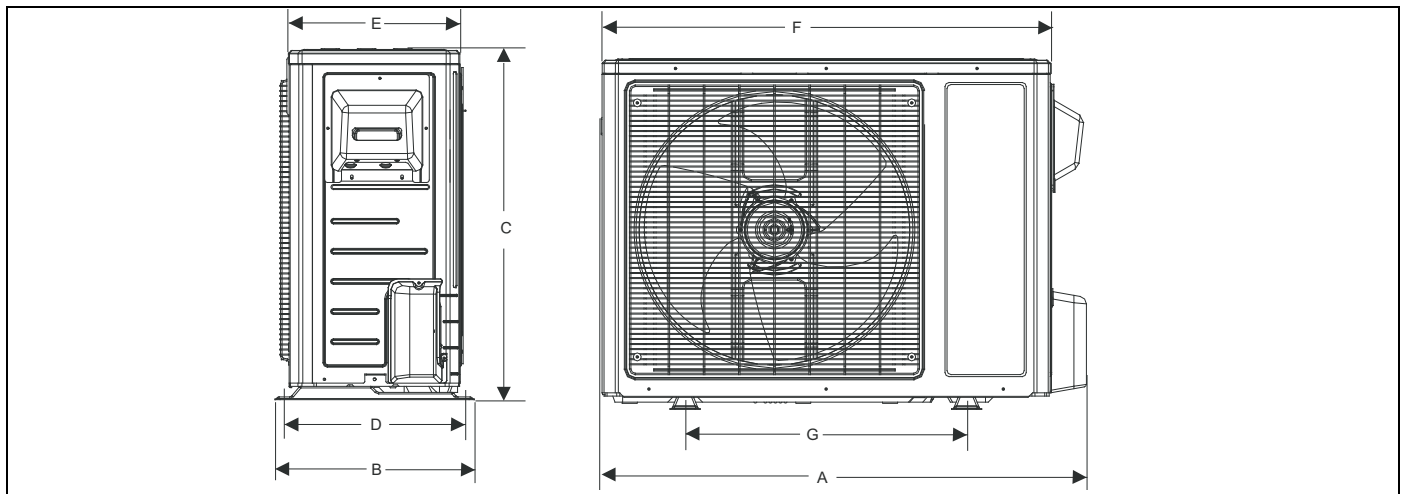

Outdoor Unit Dimensions

Model Size	A	B	C	D	E	F	G	Unit Gross Weight	
								Air Conditioner	Heat Pump
09K	28.0 (711)	12.5 (318)	21.7 (551)	11.8 (300)	10.8 (274)	25.9 (658)	18.5 (470)	73 lbs (33 kg)	73 lbs (33 kg)
12K								77 lbs (35 kg)	77 lbs (35 kg)
18K	37.9 (963)	15.6 (396)	27.6 (701)	14.4 (366)	13.4 (340)	35.0 (889)	22.0 (559)	115 lbs (52 kg)	117 lbs (53 kg)
24K								123 lbs (56 kg)	126 lbs (57 kg)

REFRIGERANT SYSTEM DIAGRAM

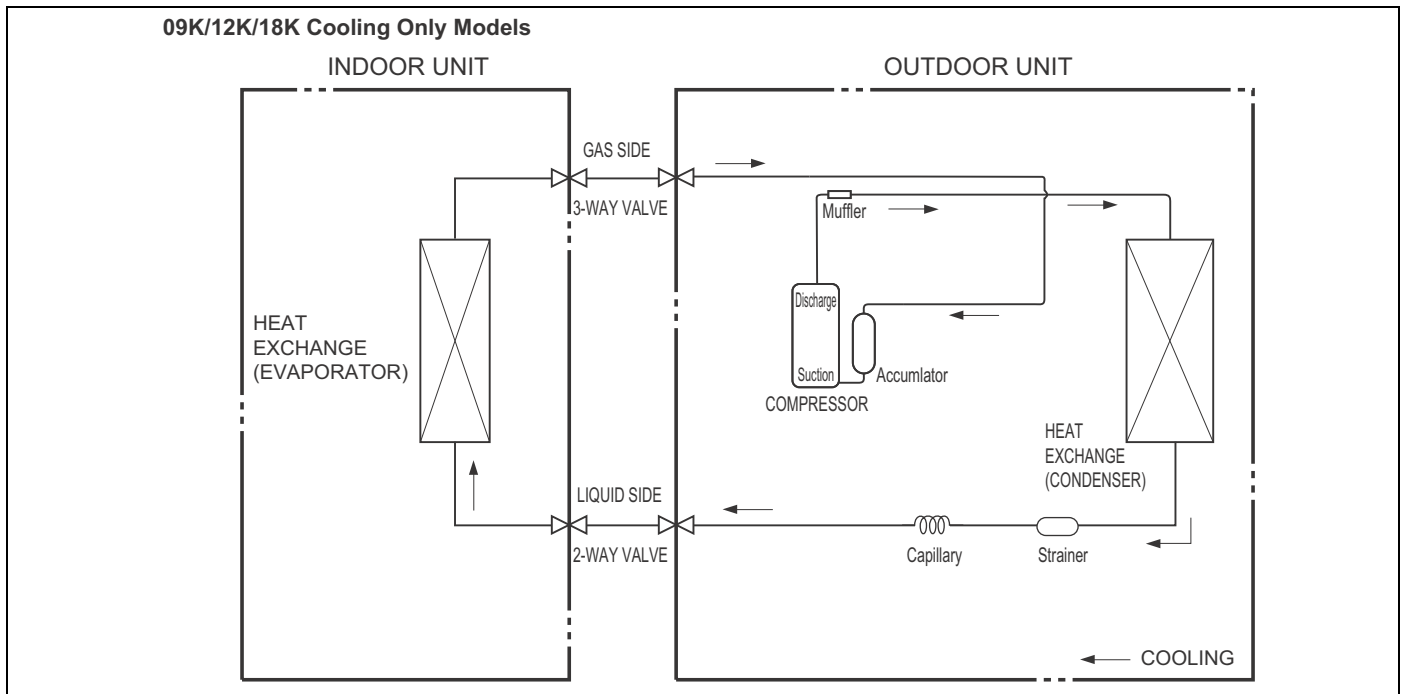

See Page 12 for notes.

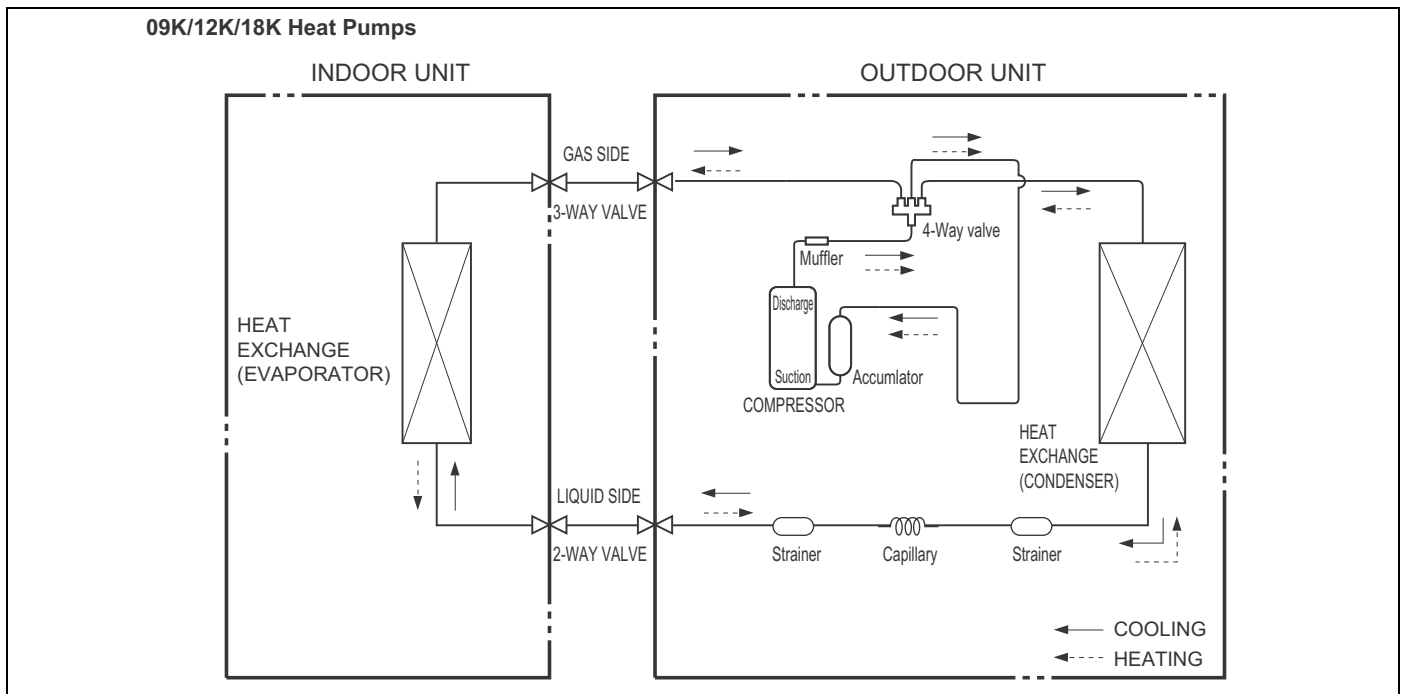

See Page 12 for notes.

WIRING DIAGRAM

Electrical Data

Symbol	Color Symbol	Symbol	Color Symbol	Symbol	Part Name
INDOOR UNIT					
BU	BIUE	BN	BROWN	⊕	PROTECTIVE EARTH
YE	YELLOW	GN	GREEN	/	/
RD	RED	BK	BLACK	/	/
YEGN	YELLOW GREEN	/	/	/	/

Symbol	Part Name	Symbol	Color Symbol	Symbol	Color Symbol
C1	CBB61	BN	BROWN	WH	WHITE
C2	CBB65	BU	BLUE	YE	YELLOW
SAT	OVERLOAD	BK	BLACK	RD	RED
COMP	COMPRESSOR	OG	ORANGE	YEGN	YELLOW GREEN
⊕	PROTECTIVE EARTH	WH	WHITE	/	/

Electrical Wiring

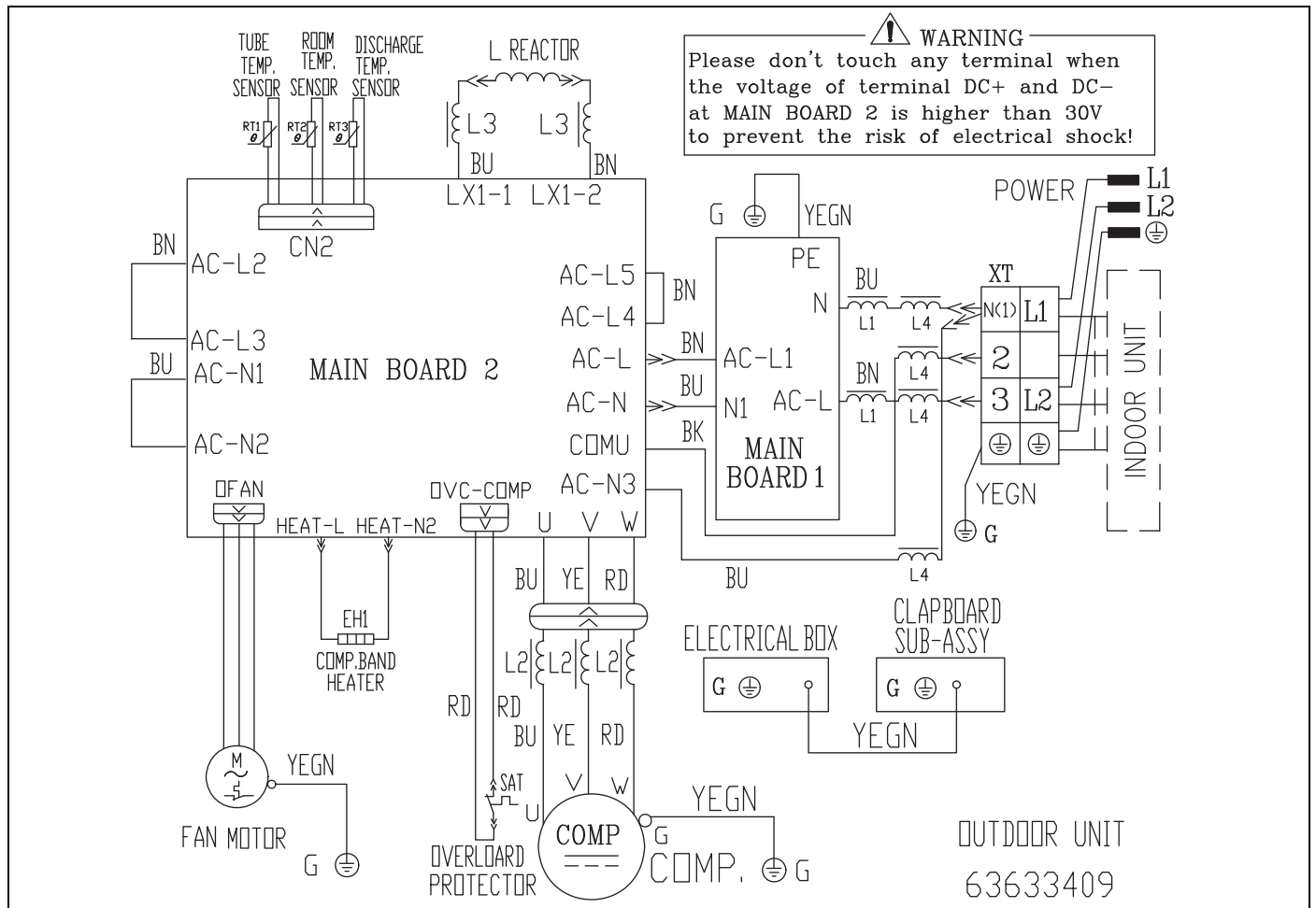

09K & 12K Outdoor Air Conditioners

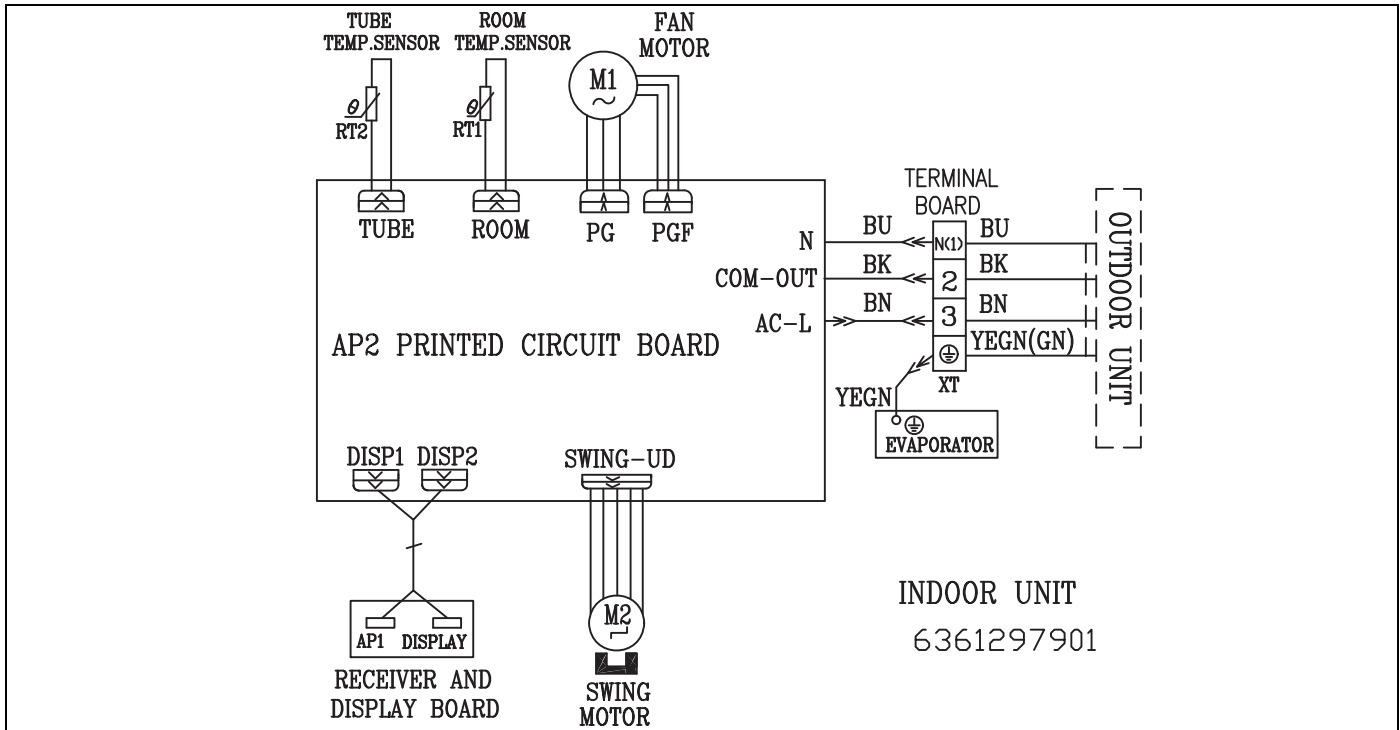

92K & 12K Indoor Air Conditioners

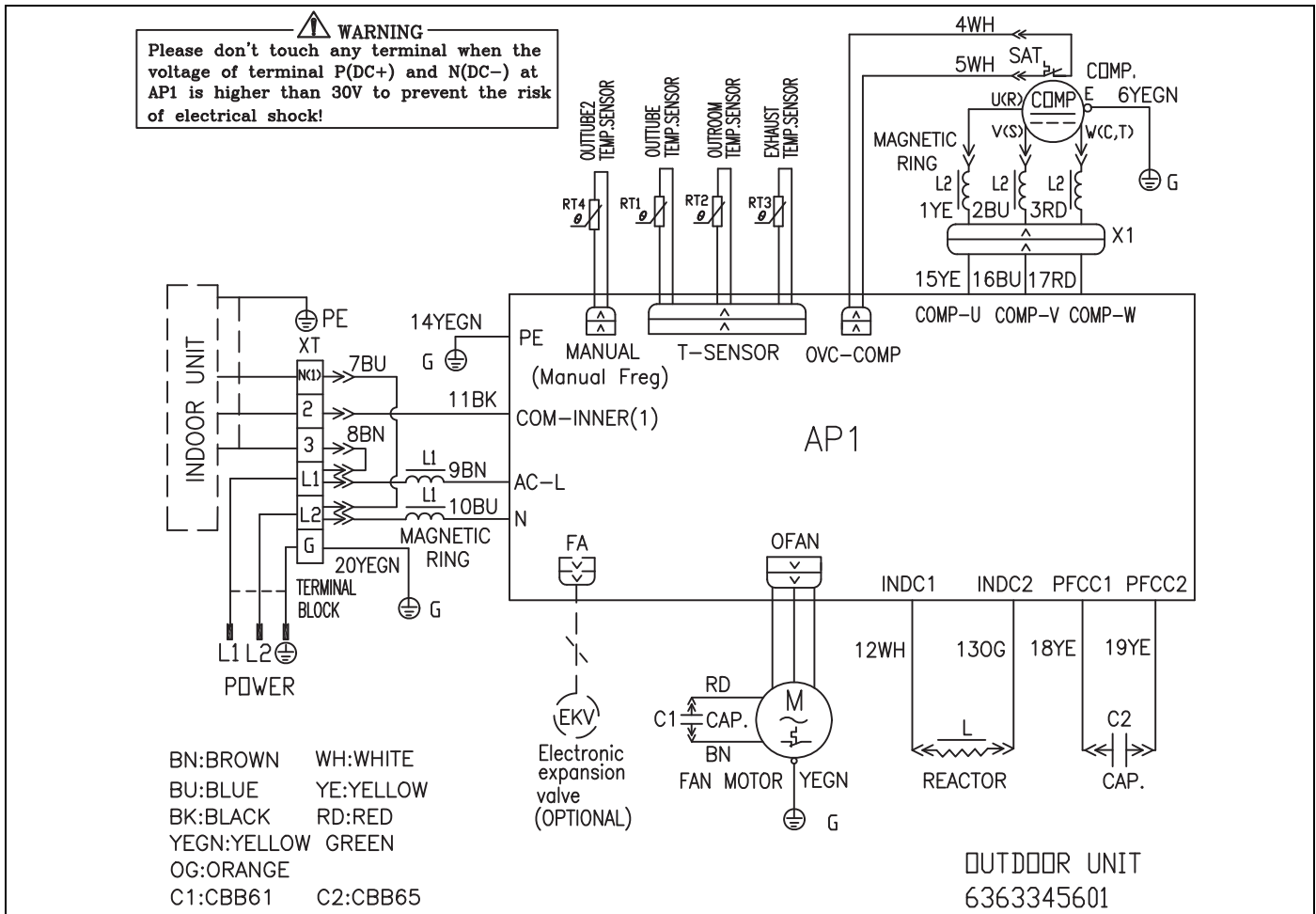

18K & 24K Outdoor Air Conditioners

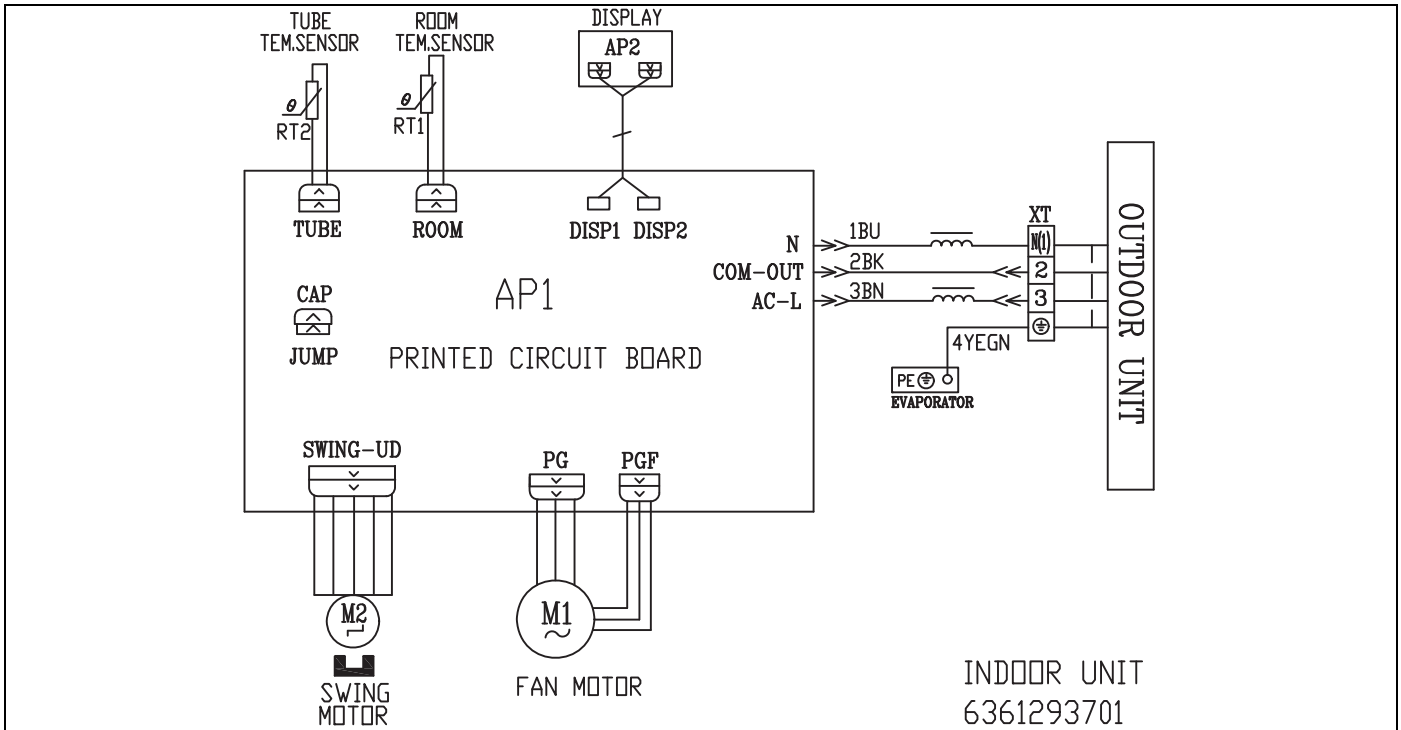

18K & 24K Indoor Air Conditioners

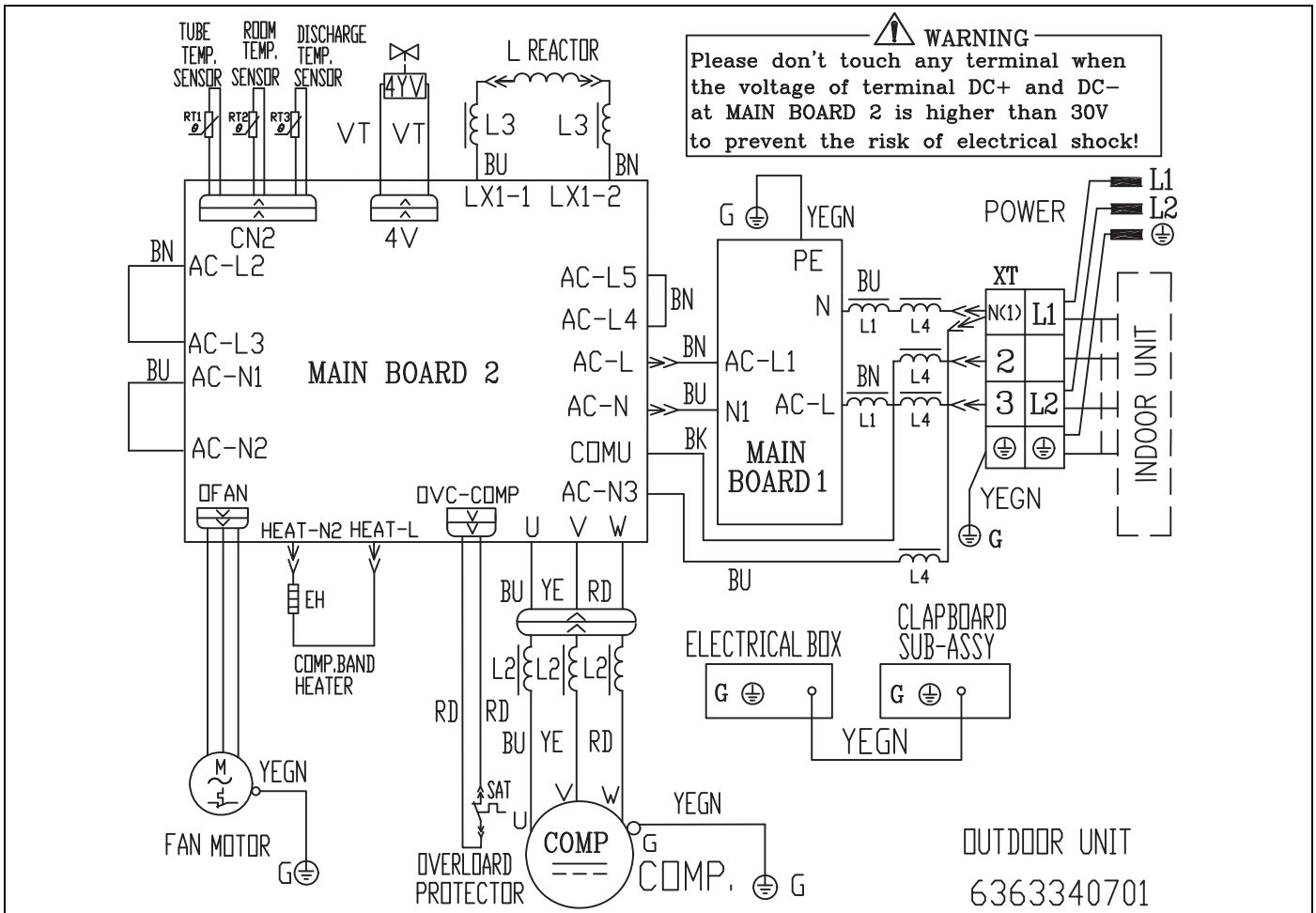

09K & 12K Outdoor Heat Pumps

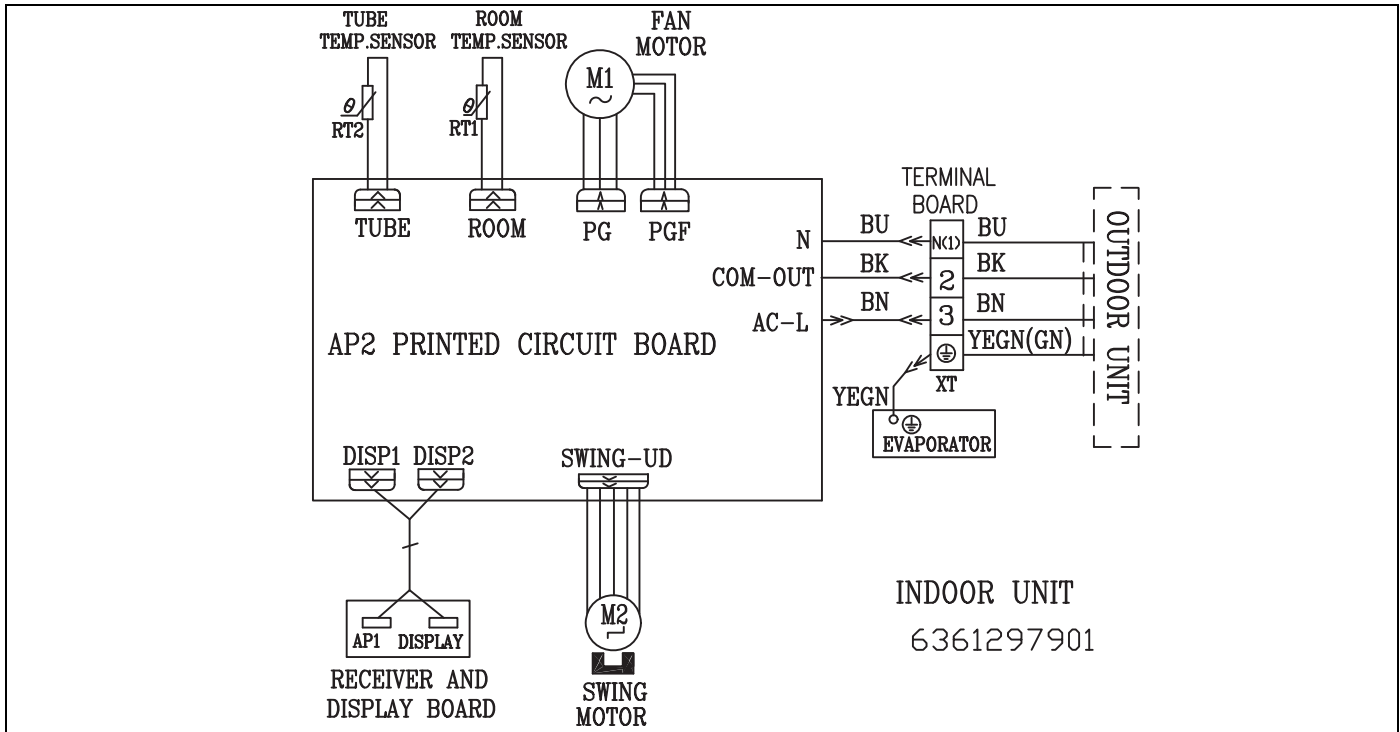

09K & 12K Indoor Heat Pumps

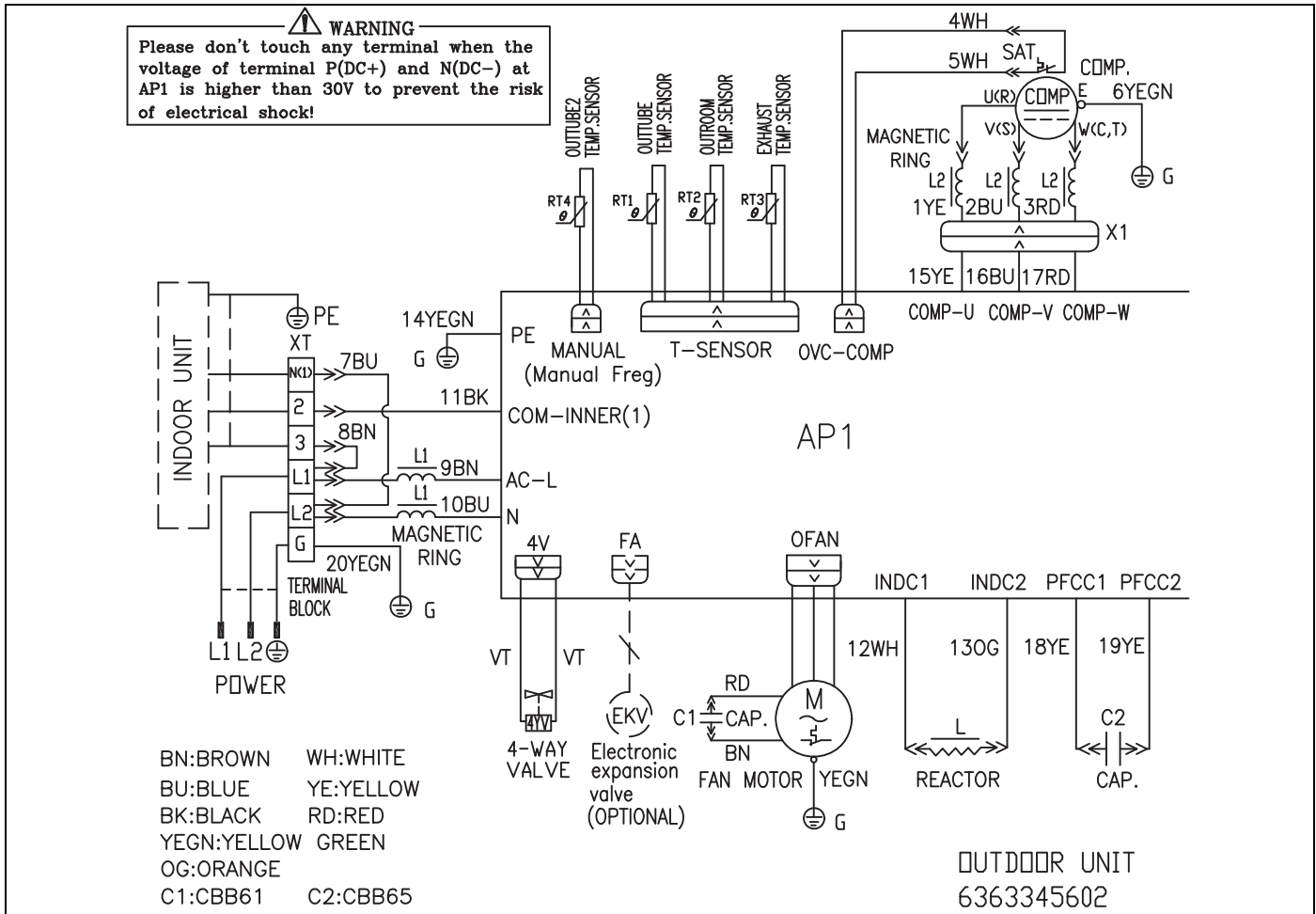

18K & 24K Outdoor Heat Pumps

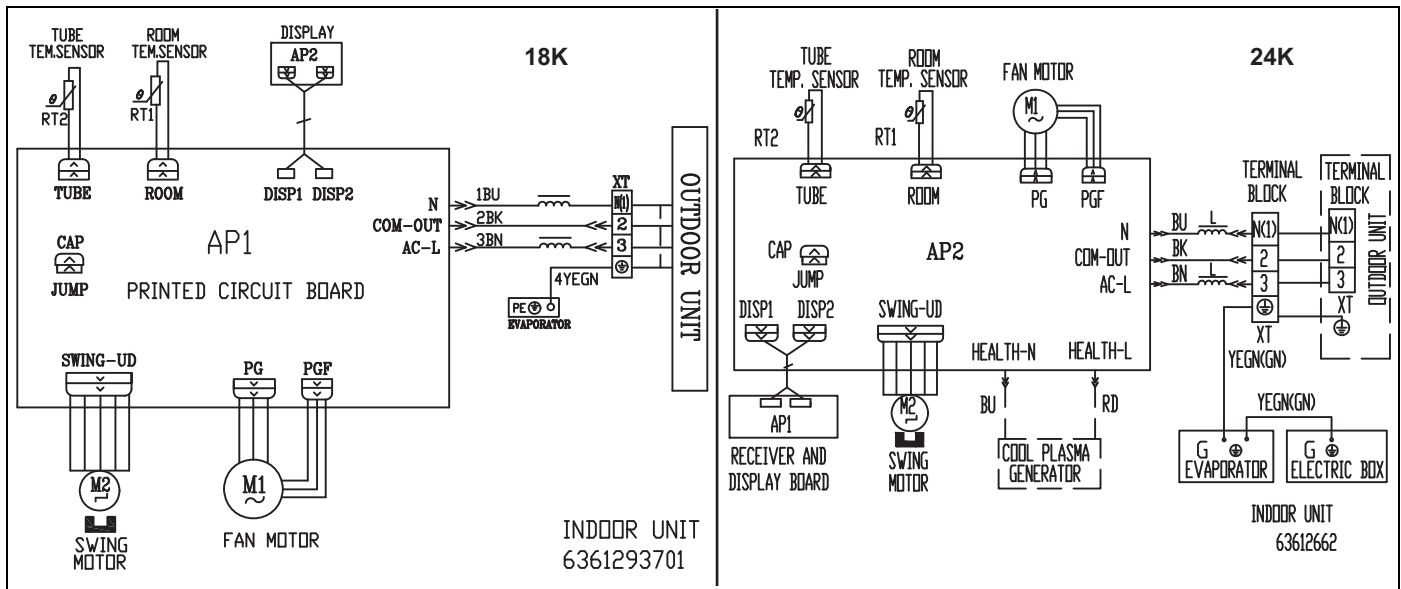

18K & 24K Indoor Heat Pumps

DESCRIPTION OF EACH CONTROL OPERATION

Temperature & Current Parameters

- Indoor preset temperature (T_{preset})
- Indoor ambient temperature (T_{amb})
- Evaporator coil temperature (T_{evap})
- Condenser coil temperature ($T_{\text{outdoor pipe}}$)
- Defrost compensation temperature ($T_{\text{compensation}}$)
- Outdoor ambient temperature ($T_{\text{outdoor amb}}$)
- Measured temperature of outdoor condensing coil under cooling mode and measured temperature of indoor evaporator coil under heating mode (T_{tube}).
- Indoor ambient temperature ($T_{\text{indoor amb}}$)

Basic Functions

Once energized, the compressor should never be restarted within less than 3 minutes. In a situation where memory function is available when energized for the first time, if the compressor is at stop before de-energized, it will re-start without a 3-minute lag. If it has been in operation before de-energized, the compressor will start with a 3-minute lag. Once started, the compressor will not be stopped within 6 minutes regardless of changes in room temperature.

Cooling Mode

1. Cooling Mode Operation

- When $T_{\text{amb}} \geq T_{\text{preset}}$, cooling mode is activated. The indoor fan, outdoor fan and the compressor will operate simultaneously. The indoor fan will run at preset speed.
- When $T_{\text{amb}} \leq T_{\text{preset}} - 3.6^\circ\text{F}$ the compressor will stop, the outdoor fan will stop with a time lag of 60 seconds, and the indoor fan will run at preset speed.
- When $T_{\text{preset}} - 3.6^\circ\text{F} < T_{\text{amb}} < T_{\text{preset}} + 1.8^\circ\text{F}$, the unit will remain at its previous state.

In cooling mode, the four-way valve will be de-energized and temperature can be set within a range from 61 to 86°F. If the compressor stops running, the indoor fan and the swing device will operate at original state.

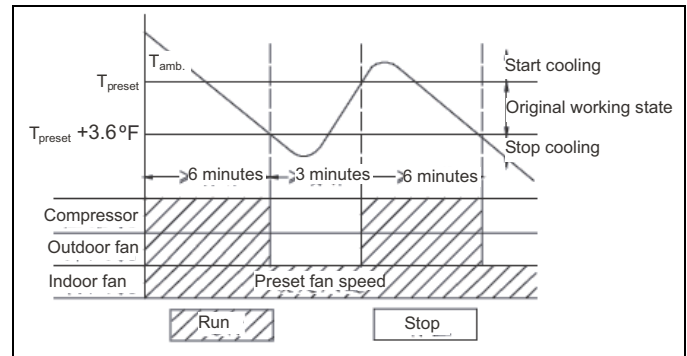

2. Protection – Cooling Mode

- Antifreeze protection - In cooling and dehumidification mode, antifreeze protection is activated 6 minutes after the compressor has started if one of followings occur:
 - $T_{\text{evap}} \leq 35.6^\circ\text{F}$, the compressor will operate at reduced frequency.
 - $T_{\text{evap}} \leq 30.2^\circ\text{F}$ is detected for a duration of 3 minutes, the compressor will stop and after 60 seconds, the outdoor fan will stop. In cooling mode, the indoor fan and the swing motor will remain at the original state.
 - $T_{\text{evap}} \geq 42.8^\circ\text{F}$ and the compressor has remained in OFF mode for at least 3 minutes, the compressor will resume its original operation state.
- Total current up and frequency down protection if the followings occur:
 - $I_{\text{total}} \leq 16\text{A}$, the compressor frequency will start to increase
 - $I_{\text{total}} \geq 17\text{A}$, the compressor frequency will not increase
 - $I_{\text{total}} \geq 18\text{A}$, the compressor will run at reduced frequency
 - $I_{\text{total}} \geq 20\text{A}$, the compressor will immediately stop and the outdoor fan will stop after 60 seconds

Dehumidification Mode

1. Dehumidification Mode Operation

- When $T_{amb} > T_{preset} + 1.8^{\circ}\text{F}$, cooling and dehumidification mode will be activated. The compressor and the outdoor fan will operate while the indoor fan runs at low speed.
- When $T_{preset} - 3.6^{\circ}\text{F} \leq T_{amb} \leq T_{preset} + 1.8^{\circ}\text{F}$, the compressor remains at its original operation state.
- When $T_{amb} < T_{preset} - 3.6^{\circ}\text{F}$, the compressor will stop, the outdoor fan will stop after 60 seconds and the indoor fan will operate at low speed.

2. Protection – Dehumidification Mode

Protection is the same as that under cooling mode section.

Heating Mode

1. Heating Mode Operation

- When $T_{amb} \leq T_{preset} + 3.6^{\circ}\text{F}$, heating mode is activated. The four-way valve, the compressor and the outdoor fan will operate simultaneously. The indoor fan will run at preset speed defined under “cold air prevention”.
- When $T_{amb} \leq T_{preset} + 9^{\circ}\text{F}$, the compressor will stop, the outdoor fan will stop after 60 seconds, and the indoor fan will continue to run at low speed for 60 seconds more.
- When $T_{preset} + 3.6^{\circ}\text{F} < T_{amb} < T_{preset} + 9^{\circ}\text{F}$, the unit will maintain its original operating status.

In heating mode, the four-way valve is energized and temperature can be set within a range of 61 - 86°F. The heating symbol and preset temperature are displayed on the indoor unit display.

2. Defrost Mode Operation

When the system has been running continuously in heating mode for more than 45 minutes, or an accumulated heating time of more than 90 minutes, and one of the following conditions are present, the unit will enter defrost mode after 3 minutes.

- $T_{outdoor\ amb} \geq 41^{\circ}\text{F}$, $T_{outdoor\ pipe} \leq 28.4^{\circ}\text{F}$;
- $28.4^{\circ}\text{F} \leq T_{outdoor\ amb}$.
- $23^{\circ}\text{F} \leq T_{outdoor\ amb} < 28.4^{\circ}\text{F}$, $T_{outdoor\ pipe} \leq 17.6^{\circ}\text{F}$;
- $14^{\circ}\text{F} \leq T_{outdoor\ amb} < 23^{\circ}\text{F}$, $T_{outdoor\ pipe} - T_{compensation} \leq (T_{outdoor\ amb} - 5.4^{\circ}\text{F})$;
- $T_{outdoor\ amb} < 14^{\circ}\text{F}$, $T_{outdoor\ pipe} - T_{compensation} \leq (T_{outdoor\ amb} - 5.4^{\circ}\text{F})$

NOTE:

After defrost mode is energized for the first time, $T_{compensation} = 0^{\circ}\text{F}$. After the first time, $T_{compensation}$ is determined by the condensing coil temperature $T_{outdoor\ pipe}$ of the last defrost cycle.

- $T_{outdoor\ pipe} > 35.6^{\circ}\text{F}$, $T_{compensation} = 0^{\circ}\text{F}$;
- $T_{outdoor\ pipe} \leq 35.6^{\circ}\text{F}$, $T_{compensation} = 5.4^{\circ}\text{F}$

When in defrost mode the following will occur in the order described:

- The indoor fan and compressor stop running
- The outdoor fan will stop running after 60 seconds.
- 30seconds later, the four-way valve will close.
- After 30 seconds, the compressor's frequency is increased to defrost frequency.
- When the compressor has operated in defrost mode for 10 minutes, or $T_{outdoor\ pipe} \geq 50^{\circ}\text{F}$, the compressor will adjust to 46Hz.
- After 30 seconds, the compressor will stop.
- After another 30 seconds, the four-way valve will open.

- After 60 seconds, the compressor and the outdoor unit fan will start running. The indoor fan will run under preset cold air prevention conditions. H1 will be displayed on the indoor unit display. Defrost frequency is 70Hz.

3. Protection – Heating Mode

- Cold air prevention (Hot Heat Pump) - In heating mode, after the compressor is energized the indoor fan is delayed under these conditions to prevent discharging cold air:
 - ♦ When $T_{indoor\ amb} < 75^{\circ}\text{F}$ if:
 - ♦ $T_{tube} \leq 104^{\circ}\text{F}$, the indoor fan will not run. The indoor fan will start running at low speed after 2 minutes.
 - ♦ Within 2 minutes, if $T_{tube} > 104^{\circ}\text{F}$, the indoor fan will start running at low speed.
 - ♦ After 1minute of operation at low speed, the indoor fan will run at preset speed.
 - ♦ Within 1-minute of low speed operation or 2-minute non-operation, if $T_{tube} > 108^{\circ}\text{F}$, the fan will run at present speed.
 - ♦ When $T_{indoor\ amb} \geq 75^{\circ}\text{F}$ if:
 - ♦ $T_{tube} \leq 108^{\circ}\text{F}$, the indoor fan will run at low speed. After one minute of operation, the indoor fan will run at preset speed.
 - ♦ Within one-minute of low speed operation, if $T_{tube} > 104^{\circ}\text{F}$, the indoor fan will run at preset speed.
- ♦ Total current up and frequency down protection occurs:
 - ♦ When $I_{total} \leq 16\text{A}$, compressor frequency can increase
 - ♦ When $I_{total} \geq 17\text{A}$, compressor frequency is not allowed to increase
 - ♦ When $I_{total} \geq 18\text{A}$, the compressor runs at reduced frequency
 - ♦ When $I_{total} \geq 20\text{A}$, the compressor stops running and the outdoor fan stops running after 60 seconds.

Fan Mode

In this mode, the indoor fan will run at preset speed. The compressor, the outdoor fan and the four-way valve will not be running.

- In fan mode, temperature can be set within a range of 61 - 86°F.

AUTO Mode

1. AUTO Mode Operation

In AUTO mode, the default cooling setpoint temperature T_{preset} is 77°F and the default heating setpoint temperature T_{preset} is 68°F. Once activated, the following will occur under these conditions:

- When $T_{amb} \leq 71.6^{\circ}\text{F}$, heating mode is activated.
- When $71.6^{\circ}\text{F} < T_{amb} < 78.8^{\circ}\text{F}$, fan mode is activated and the fan icon is displayed on the indoor unit display.
- When $T_{amb} \geq 78.8^{\circ}\text{F}$, cooling mode is activated.
- When $T_{amb} \geq T_{preset} + 1.8^{\circ}\text{F}$, the system runs in cooling mode. The preset temperature is 77°F;
- When $T_{amb} \leq T_{preset} - 1.8^{\circ}\text{F}$, the compressor stops running, the outdoor fan stops running after 1 minute, and the indoor fan continues to run at a preset speed.
- When $T_{preset} - 1.8^{\circ}\text{F} < T_{amb} < T_{preset} + 1.8^{\circ}\text{F}$, the system continues to run normally.
- When $T_{amb} \leq T_{preset} + 3.6^{\circ}\text{F}$, heating mode is activated.
- $T_{amb} \geq T_{preset} + 9^{\circ}\text{F}$, the compressor stops running, the outdoor fan stops running after 1 minute, and the indoor fan continues to run for about 30 seconds before it stops.

- When $T_{\text{preset}} + 3.6^{\circ}\text{F} < T_{\text{amb.}} < T_{\text{preset}} + 41^{\circ}\text{F}$, the system continues to run normally
- When $71.6^{\circ}\text{F} < T_{\text{amb.}} < 78.8^{\circ}\text{F}$, the system continues to run normally.

2. Protection – Auto Mode

- When the system is running in cooling mode, the protections described in “Protection - Cooling Mode” apply.
- When the system is running in heating mode, the protections described in “Protection – Heating Mode” apply.
- When the ambient temperature changes, operation mode will switch back and forth. Once the compressor is energized, it will keep running for a minimum of 6 minutes.

COMMON PROTECTION FUNCTIONS AND FAULT DISPLAY UNDER COOL, HEAT, DRY AND AUTO MODES

1. Overload Protection

- Cooling Overload
 - ♦ When $T_{\text{tube}} \leq 126^{\circ}\text{F}$, the system operates normally.
 - ♦ When $T_{\text{tube}} \geq 131^{\circ}\text{F}$, compressor frequency is not allowed to increase.
 - ♦ When $T_{\text{tube}} \geq 136^{\circ}\text{F}$, compressor will run at reduced frequency.
 - ♦ When $T_{\text{tube}} \geq 144^{\circ}\text{F}$, compressor is de-energized and the indoor fan will continue to run at preset speed.
- Heating Overload
 - ♦ When $T_{\text{tube}} \leq 126^{\circ}\text{F}$, the system operates normally.
 - ♦ When $T_{\text{tube}} \geq 131^{\circ}\text{F}$, compressor frequency is not allowed to increase.
 - ♦ When $T_{\text{tube}} \geq 136^{\circ}\text{F}$, compressor will run at reduced frequency.

- When $T_{\text{tube}} \geq 144^{\circ}\text{F}$, compressor is de-energized and the indoor fan will continue to run for about 30 seconds and stops.

2. High Discharge Temperature Compressor Protection

- When compressor discharge temperature is $\geq 208^{\circ}\text{F}$, compressor frequency is not allowed to increase.
- When compressor discharge temperature is $\geq 217^{\circ}\text{F}$, compressor will run at reduced frequency.
- When compressor discharge temperature is $\geq 230^{\circ}\text{F}$, the compressor will stop.
- When compressor discharge temperature is $\leq 194^{\circ}\text{F}$ and the compressor has been idle for at least 3 minutes, it will resume its operation.

3. Communication Fault

If the system fails to receive communication signals for more than 3 minutes, its operation will stop.

4. Module Protection

- Under module protection mode, the compressor will stop.
- If the compressor remains idle for at least 3 minutes, it will resume its operation.
- If module protection occurs six consecutive times, the compressor will not be allowed to start again.

5. Overload Protection

- If the overload temperature is over 239°F , the compressor will stop and the outdoor fan will stop after 30 seconds.
- If the overload temperature drops below 203°F , the compressor overload protection is reset.
- If voltage on the DC bus is below 150V or over 420V, the compressor will stop and the outdoor fan will stop after 30 seconds.
- When voltage on the DC bus returns to its normal value and the compressor has been idle for at least 3 minutes, the compressor will resume its operation.

6. Temperature Sensors Faults.

Designation of Sensors	Faults
Indoor ambient temperature	The sensor is detected to be open-circuited or short-circuited for a continuous 30 seconds.
Indoor tube temperature	The sensor is detected to be open-circuited or short-circuited for a continuous 30 seconds.
Outdoor ambient temperature	The sensor is detected to be open-circuited or short-circuited for a continuous 30 seconds.
Outdoor tube temperature	The sensor is detected to be open-circuited or short-circuited for a continuous 30 seconds and no detection is performed within 10 minutes after defrost begins.
Exhaust	After the compressor has operated for 3minutes, the sensor is detected to be open-circuited or short-circuited for a continuous 30 seconds.
Overload	After the compressor has operated for 3minutes, the sensor is detected to be open-circuited or short-circuited for a continuous 30 seconds.

RESISTANCE TABLES

Resistance Table of Ambient Temperature Sensor for Indoor and Outdoor Units (15K)							
Temp. (°F)	Resistance (kΩ)	Temp. (°F)	Resistance (kΩ)	Temp. (°F)	Resistance (kΩ)	Temp. (°F)	Resistance (kΩ)
-2.2	138.1	68	18.75	138.2	3.848	208.4	1.071
-0.4	128.6	69.8	17.93	140	3.711	210.2	1.039
1.4	121.6	71.6	17.14	141.8	3.579	212	1.009
3.2	115	73.4	16.39	143.6	3.454	213.8	0.98
5	108.7	75.2	15.68	145.4	3.333	215.6	0.952
6.8	102.9	77	15	147.2	3.217	217.4	0.925
8.6	97.4	78.8	14.36	149	3.105	219.2	0.898
10.4	92.22	80.6	13.74	150.8	2.998	221	0.873
12.2	87.35	82.4	13.16	152.6	2.896	222.8	0.848
14	82.75	84.2	12.6	154.4	2.797	224.6	0.825
15.8	78.43	86	12.07	156.2	2.702	226.4	0.802
17.6	74.35	87.8	11.57	158	2.611	228.2	0.779
19.4	70.5	89.6	11.09	159.8	2.523	230	0.758
21.2	66.88	91.4	10.63	161.6	2.439	231.8	0.737
23	63.46	93.2	10.2	163.4	2.358	233.6	0.717
24.8	60.23	95	9.779	165.2	2.28	235.4	0.697
26.6	57.18	96.8	9.382	167	2.206	237.2	0.678
28.4	54.31	98.6	9.003	168.8	2.133	239	0.66
30.2	51.59	100.4	8.642	170.6	2.064	240.8	0.642
32	49.02	102.2	8.297	172.4	1.997	242.6	0.625
33.8	46.6	104	7.967	174.2	1.933	244.4	0.608
35.6	44.31	105.8	7.653	176	1.871	246.2	0.592
37.4	42.14	107.6	7.352	177.8	1.811	248	0.577
39.2	40.09	109.4	7.065	179.6	1.754	249.8	0.561
41	38.15	111.2	6.791	181.4	1.699	251.6	0.547
42.8	36.32	113	6.529	183.2	1.645	253.4	0.532
44.6	34.58	114.8	6.278	185	1.594	255.2	0.519
46.4	32.94	116.6	6.038	186.8	1.544	257	0.505
48.2	31.38	118.4	5.809	188.6	1.497	258.8	0.492
50	29.9	120.2	5.589	190.4	1.451	260.6	0.48
51.8	28.51	122	5.379	192.2	1.408	262.4	0.467
53.6	27.18	123.8	5.197	194	1.363	264.2	0.456
55.4	25.92	125.6	4.986	195.8	1.322	266	0.444
57.2	24.73	127.4	4.802	197.6	1.282	267.8	0.433
59	23.6	129.2	4.625	199.4	1.244	269.6	0.422
60.8	22.53	131	4.456	201.2	1.207	271.4	0.412
62.6	21.51	132.8	4.294	203	1.171	273.2	0.401
64.4	20.54	134.6	4.139	204.8	1.136	275	0.391
66.2	19.63	136.4	3.99	206.6	1.103	276.8	0.382

Resistance Table of Outdoor and Indoor Tube Temperature Sensors (20K)							
Temp. (°F)	Resistance (kΩ)	Temp. (°F)	Resistance (kΩ)	Temp. (°F)	Resistance (kΩ)	Temp. (°F)	Resistance (kΩ)
-2.2	181.4	68	25.01	138.2	5.13	208.4	1.427
-0.4	171.4	69.8	23.9	140	4.948	210.2	1.386
1.4	162.1	71.6	22.85	141.8	4.773	212	1.346
3.2	153.3	73.4	21.85	143.6	4.605	213.8	1.307
5	145	75.2	20.9	145.4	4.443	215.6	1.269
6.8	137.2	77	20	147.2	4.289	217.4	1.233
8.6	129.9	78.8	19.14	149	4.14	219.2	1.198
10.4	123	80.6	18.13	150.8	3.998	221	1.164
12.2	116.5	82.4	17.55	152.6	3.861	222.8	1.131
14	110.3	84.2	16.8	154.4	3.729	224.6	1.099
15.8	104.6	86	16.1	156.2	3.603	226.4	1.069
17.6	99.13	87.8	15.43	158	3.481	228.2	1.039
19.4	94	89.6	14.79	159.8	3.364	230	1.01
21.2	89.17	91.4	14.18	161.6	3.252	231.8	0.983
23	84.61	93.2	13.59	163.4	3.144	233.6	0.956
24.8	80.31	95	13.04	165.2	3.04	235.4	0.93
26.6	76.24	96.8	12.51	167	2.94	237.2	0.904
28.4	72.41	98.6	12	168.8	2.844	239	0.88
30.2	68.79	100.4	11.52	170.6	2.752	240.8	0.856
32	65.37	102.2	11.06	172.4	2.663	242.6	0.833
33.8	62.13	104	10.62	174.2	2.577	244.4	0.811
35.6	59.08	105.8	10.2	176	2.495	246.2	0.77
37.4	56.19	107.6	9.803	177.8	2.415	248	0.769
39.2	53.46	109.4	9.42	179.6	2.339	249.8	0.746
41	50.87	111.2	9.054	181.4	2.265	251.6	0.729
42.8	48.42	113	8.705	183.2	2.194	253.4	0.71
44.6	46.11	114.8	8.37	185	2.125	255.2	0.692
46.4	43.92	116.6	8.051	186.8	2.059	257	0.674
48.2	41.84	118.4	7.745	188.6	1.996	258.8	0.658
50	39.87	120.2	7.453	190.4	1.934	260.6	0.64
51.8	38.01	122	7.173	192.2	1.875	262.4	0.623
53.6	36.24	123.8	6.905	194	1.818	264.2	0.607
55.4	34.57	125.6	6.648	195.8	1.736	266	0.592
57.2	32.98	127.4	6.403	197.6	1.71	267.8	0.577
59	31.47	129.2	6.167	199.4	1.658	269.6	0.563
60.8	30.04	131	5.942	201.2	1.609	271.4	0.549
62.6	28.68	132.8	5.726	203	1.561	273.2	0.535
64.4	27.39	134.6	5.519	204.8	1.515	275	0.521
66.2	26.17	136.4	5.32	206.6	1.47	276.8	0.509

Resistance Table of Outdoor Discharge Temperature Sensor (50K)							
Temp. (°F)	Resistance (kΩ)	Temp. (°F)	Resistance (kΩ)	Temp. (°F)	Resistance (kΩ)	Temp. (°F)	Resistance (kΩ)
-20.2	853.5	50	98	120.2	18.34	190.4	4.754
-18.4	799.8	51.8	93.42	122	17.65	192.2	4.609
-16.6	750	53.6	89.07	123.8	16.99	194	4.469
-14.8	703.8	55.4	84.95	125.6	16.36	195.8	4.334
-13	660.8	57.2	81.05	127.4	15.75	197.6	4.204
-11.2	620.8	59	77.35	129.2	15.17	199.4	4.079
-9.4	580.6	60.8	73.83	131	14.62	201.2	3.958
-7.6	548.9	62.6	70.5	132.8	14.09	203	3.841
-5.8	516.6	64.4	67.34	134.6	13.58	204.8	3.728
-4	486.5	66.2	64.33	136.4	13.09	206.6	3.619
-2.2	458.3	68	61.48	138.2	12.62	208.4	3.514
-0.4	432	69.8	58.77	140	12.17	210.2	3.413
1.4	407.4	71.6	56.19	141.8	11.74	212	3.315
3.2	384.5	73.4	53.74	143.6	11.32	213.8	3.22
5	362.9	75.2	51.41	145.4	10.93	215.6	3.129
6.8	342.8	77	49.19	147.2	10.54	217.4	3.04
8.6	323.9	78.8	47.08	149	10.18	219.2	2.955
10.4	306.2	80.6	45.07	150.8	9.827	221	2.872
12.2	289.6	82.4	43.16	152.6	9.489	222.8	2.792
14	274	84.2	41.34	154.4	9.165	224.6	2.715
15.8	259.3	86	39.61	156.2	8.854	226.4	2.64
17.6	245.6	87.8	37.96	158	8.555	228.2	2.568
19.4	232.6	89.6	36.38	159.8	8.268	230	2.498
21.2	220.5	91.4	34.88	161.6	7.991	231.8	2.431
23	209	93.2	33.45	163.4	7.726	233.6	2.365
24.8	198.3	95	32.09	165.2	7.47	235.4	2.302
26.6	199.1	96.8	30.79	167	7.224	237.2	2.241
28.4	178.5	98.6	29.54	168.8	6.998	239	2.182
30.2	169.5	100.4	28.36	170.6	6.761	240.8	2.124
32	161	102.2	27.23	172.4	6.542	242.6	2.069
33.8	153	104	26.15	174.2	6.331	244.4	2.015
35.6	145.4	105.8	25.11	176	6.129	246.2	1.963
37.4	138.3	107.6	24.13	177.8	5.933	248	1.912
39.2	131.5	109.4	23.19	179.6	5.746	249.8	1.863
41	125.1	111.2	22.29	181.4	5.565	251.6	1.816
42.8	119.1	113	21.43	183.2	5.39	253.4	1.77
44.6	113.4	114.8	20.6	185	5.222	255.2	1.725
46.4	108	116.6	19.81	186.8	5.06	257	1.682
48.2	102.8	118.4	19.06	188.6	4.904	258.8	1.64

REMOVAL PROCEDURE
Removal Procedure of Indoor Unit



Be sure to wait for a minimum of 10 minutes after turning off all power supplies before disassembly.

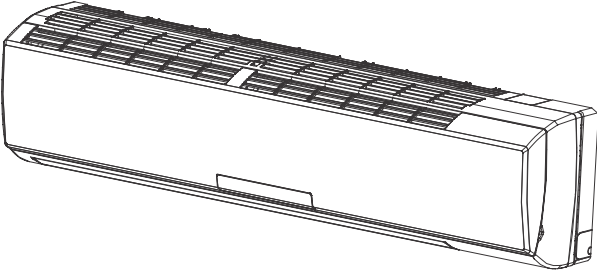
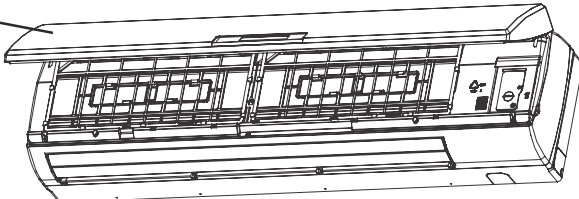
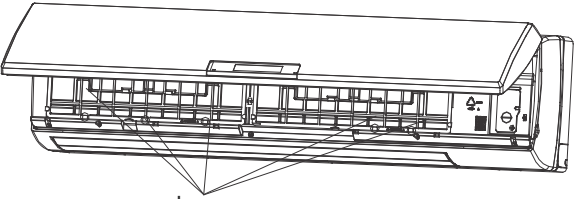
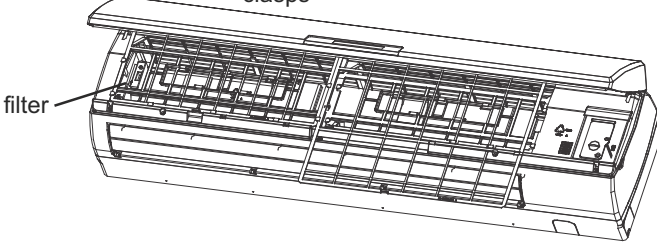
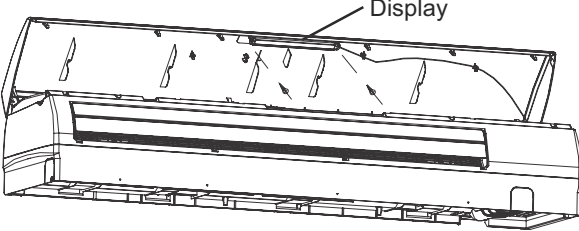

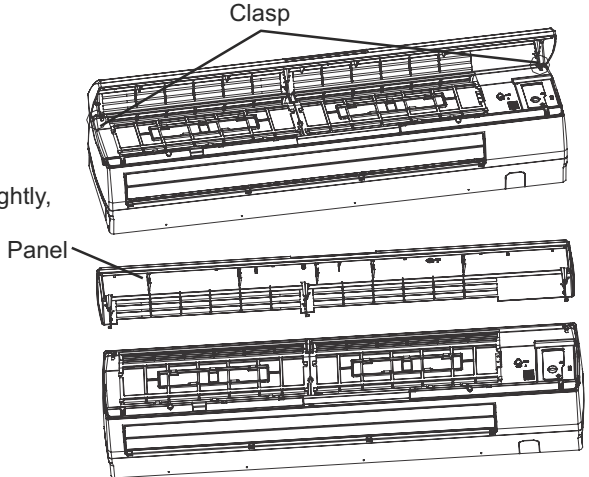
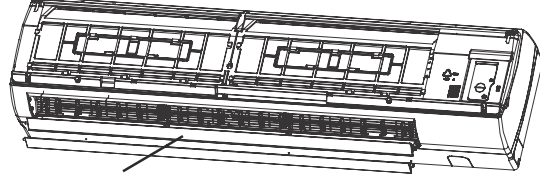
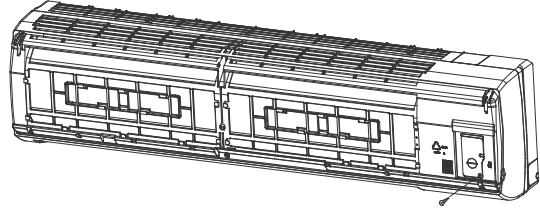
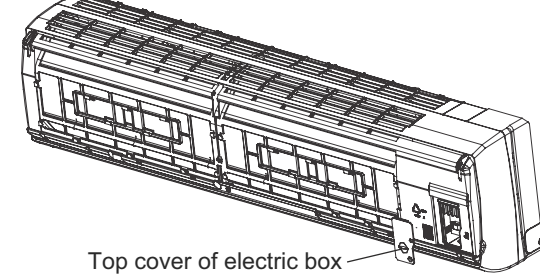
STEPS	PROCEDURES
<p>1. Before disassembly of the unit</p>	<p>Axonometric drawing for the complete unit.</p> 
<p>2. Remove filter</p>	<p>a. Open the panel.</p>  <p>b. Loosen the clasps on the filter.</p>  <p>c. Draw out two pieces of filter.</p> 
<p>3. Remove display</p>	<p>Remove 2 screws fixing display, and then remove the filter.</p> 

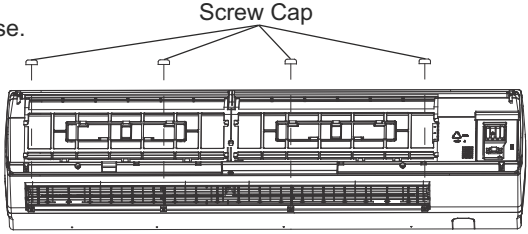
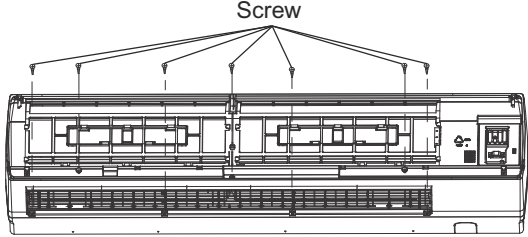
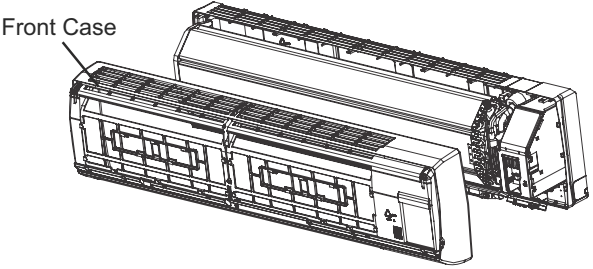
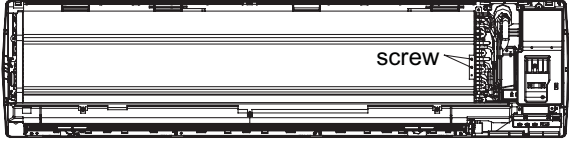
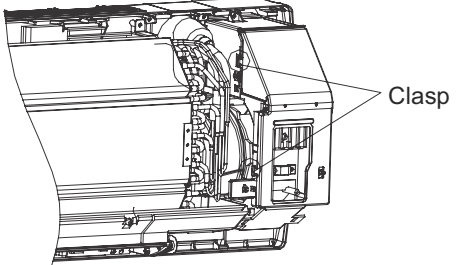
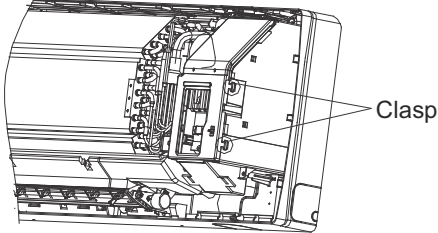
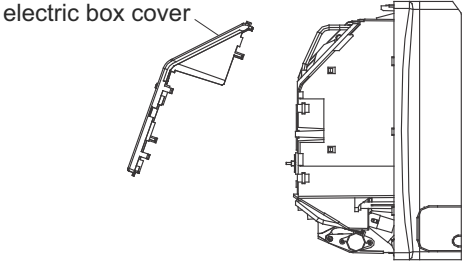
STEPS	PROCEDURES
<p>4. Remove panel</p>	<p>Pull the clasps at both sides slightly, and then remove the panel.</p> 
<p>5. Remove horizontal louver</p>	<p>Remove the axial bush on the horizontal louver, and then remove the horizontal louver.</p> 
<p>6. Remove top cover of electric box</p>	<p>a. Remove screws fixing the top cover of electric box.</p>  <p>b. Remove the top cover of electric box.</p> 

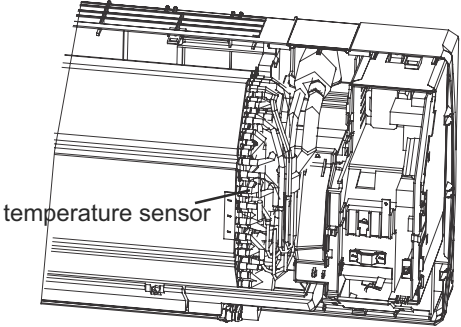
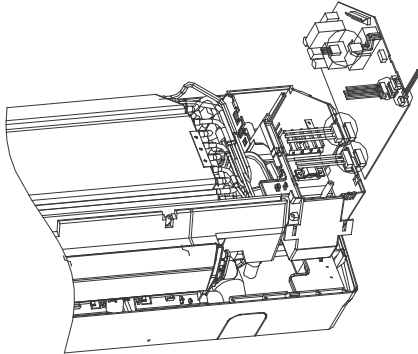
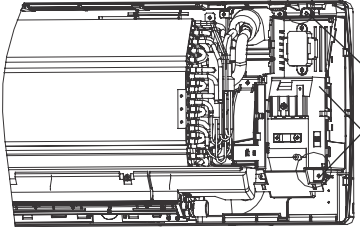
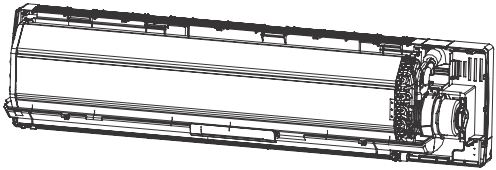
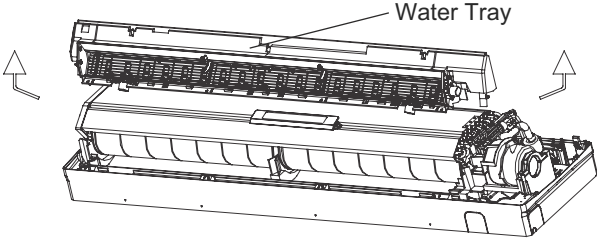
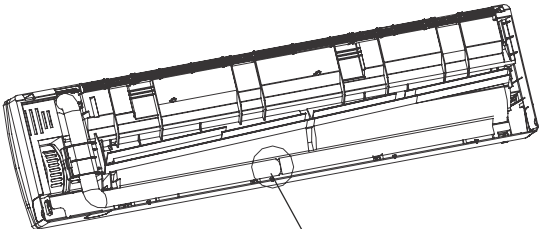
STEPS	PROCEDURES
<p>7. Remove front case</p>	<p>a. Remove the screw caps on front case.</p>  <p>Screw Cap</p> <p>b. Remove screws connecting the front case.</p>  <p>Screw</p> <p>c. Remove the front case.</p>  <p>Front Case</p>
<p>8. Remove earthing wire</p>	<p>Remove earthing screws, and then remove the earthing wire.</p>  <p>screw</p>
<p>9. Remove electric box cover</p>	<p>a. Loosen clasps at the left side of electric box.</p>  <p>Clasp</p> <p>b. Loosen clasps on the right side of electric box.</p>  <p>Clasp</p> <p>c. Remove electric box cover.</p>  <p>electric box cover</p>

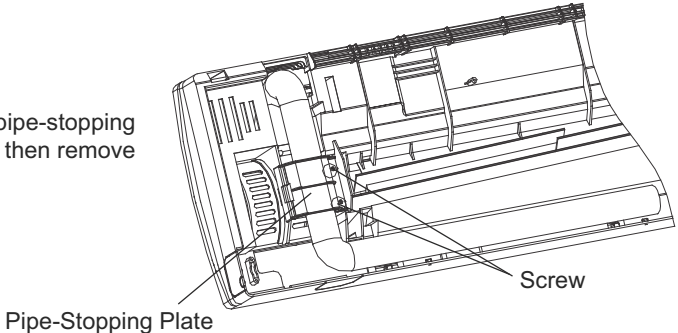
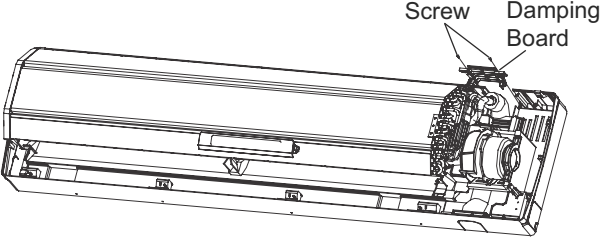
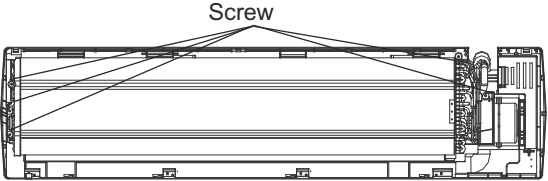
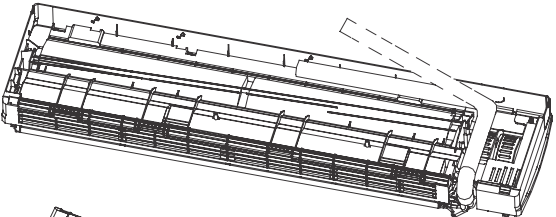
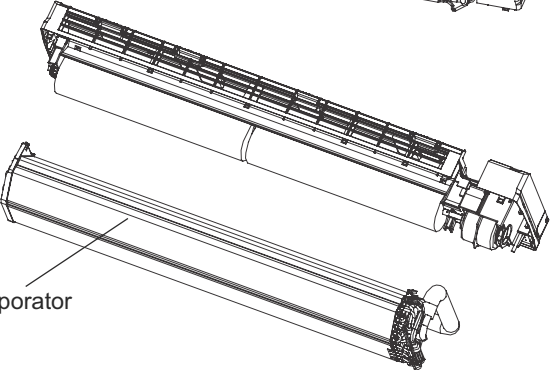
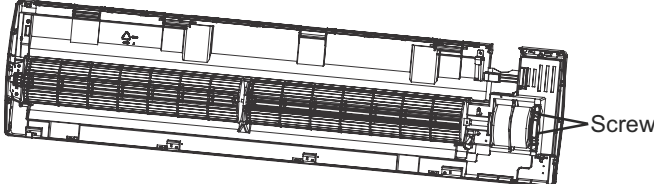
STEPS	PROCEDURES
<p>10. Remove temperature sensor</p>	<p>Pull out the indoor temperature sensor.</p>  <p>temperature sensor</p>
<p>11. Remove electric box</p>	<p>a. Pull out 6 sockets on PCB board.</p>  <p>b. Pull out two screws on electric box.</p>  <p>Screw Electric Box</p> <p>c. Remove the electric box.</p> 
<p>12. Remove water tray</p>	<p>Pull the water tray upwards, and then remove the water tray.</p>  <p>Water Tray</p>
<p>13. Remove connection pipe between indoor and outdoor units</p>	<p>Separate the connection pipe between indoor and outdoor units.</p>  <p>Connection position for indoor and outdoor units' connection pipe</p>

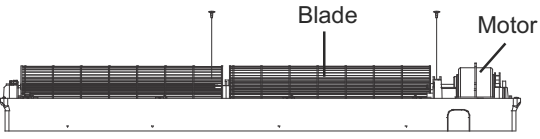
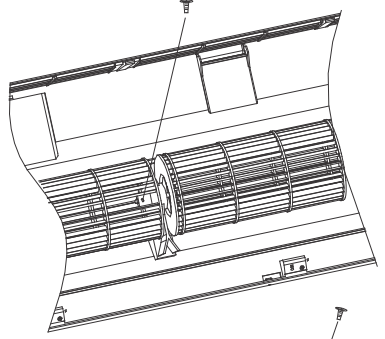
STEPS	PROCEDURES
<p>14. Remove pipe-stopping plate</p>	<p>Remove two screws on pipe-stopping plate for indoor unit, and then remove the pipe-stopping</p>  <p>Pipe-Stopping Plate</p> <p>Screw</p>
<p>15. Remove damping board</p>	<p>Remove 2 screws on damping board, and then remove the damping board.</p>  <p>Screw</p> <p>Damping Board</p>
<p>16. Remove evaporator</p>	<p>a. Remove screws between evaporator and bottom case.</p>  <p>Screw</p> <p>b. Turn over the indoor unit and adjust the pipe line to the position as shown by the broken line.</p>  <p>c. Lift up the evaporator, and then remove the evaporator.</p>  <p>Evaporator</p>
<p>17. Remove the fixing plate of motor</p>	<p>Remove 2 screws on fixing plate of motor, and then remove the fixing plate of motor.</p>  <p>Screw</p>

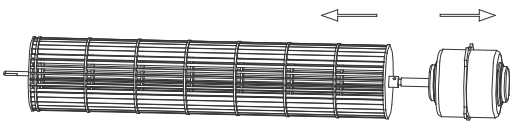
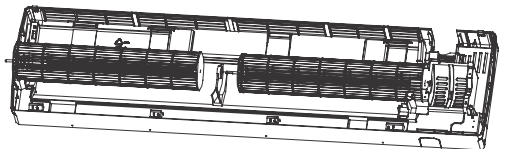
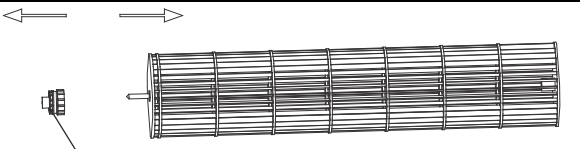
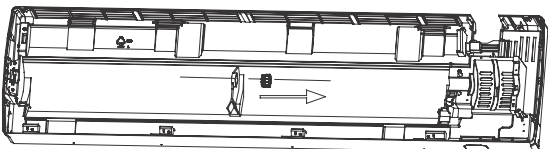
STEPS	PROCEDURES
<p>18. Remove cross flow blade and motor</p>	<p>a. Remove screws fixing cross flow blade and motor.</p>  <p>Blade Motor</p>   <p>b. Remove the motor sub-assy.</p>  <p>c. Separate two cross flow blade.</p> 
<p>19. Remove cushion rubber</p>	<p>a. Remove the cushion rubber on cross flow blade.</p>  <p>Cushion Rubber</p> <p>b. Remove the cushion rubber from the base.</p> 

Removal Procedure of Outdoor Unit

WARNING

Be sure to wait for a minimum of 10 minutes after turning off all power supplies before disassembly.

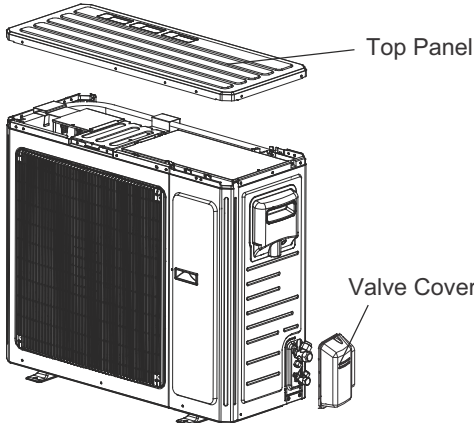
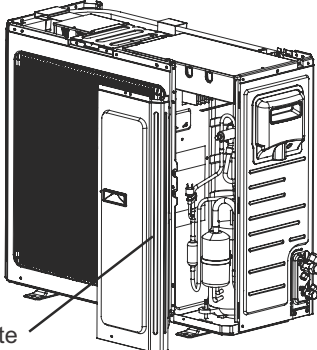
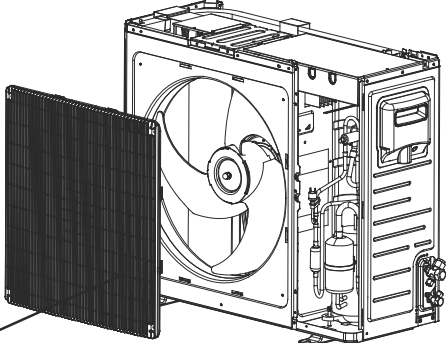
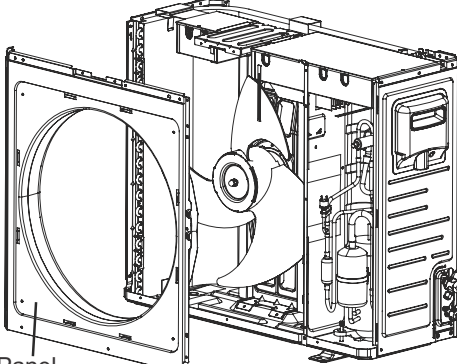
STEPS	PROCEDURES
<p>1. Remove top cover and front side plate</p>	<p>a. Use the screwdriver to remove the screws connecting the top panel and panel and side panels. Remove the top panel. Loosen the screws fixing the valve cover and then remove the valve cover.</p> <p>b. Loosen the screws connecting the front side panel and mask and chassis. Remove the front side panel.</p>   <p>Top Panel</p> <p>Valve Cover</p> <p>Front Side Plate</p>
<p>2. Remove grille</p>	<p>Twist off the screws connecting the grille and panel, and then remove the grille.</p>  <p>Grille</p>
<p>3. Remove panel</p>	<p>Twist off the screws connecting the panel, chassis and motor support with screwdriver, and then remove the panel.</p>  <p>Panel</p>

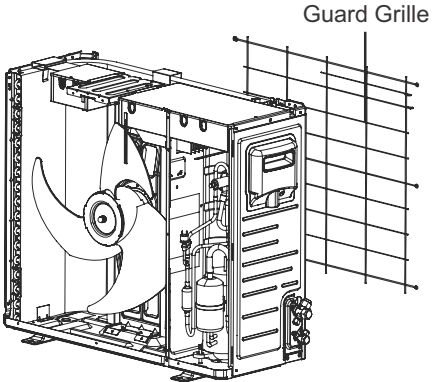
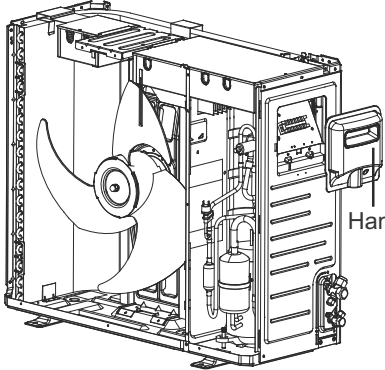
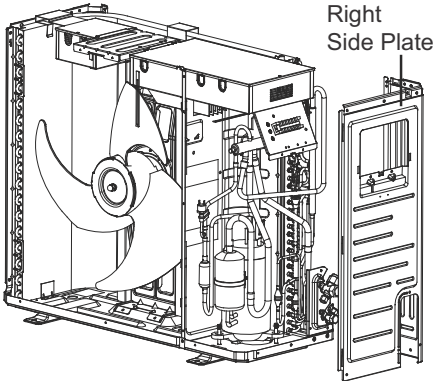
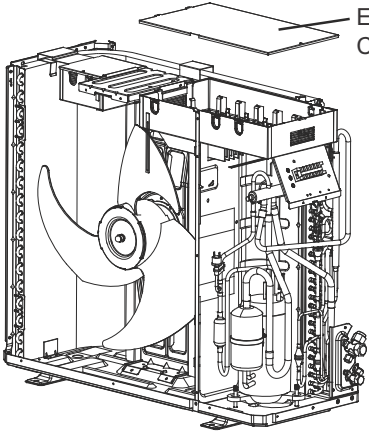
STEPS	PROCEDURES
<p>4. Remove guard grille</p>	<p>Twist off the screws fixing the guard grille and then remove the guard grille.</p>  <p style="text-align: right;">Guard Grille</p>
<p>5. Remove handle</p>	<p>Twist off the screws fixing the handle and then remove the handle.</p>  <p style="text-align: right;">Handle</p>
<p>6. Remove right side plate</p>	<p>Twist off the screws connecting the right side plate and chassis, valve support and condenser, and then remove the right side plate.</p>  <p style="text-align: right;">Right Side Plate</p>
<p>7. Remove electric box</p>	<p>a. Twist off the screws on electric box cover with screwdriver, and then remove the electric box cover.</p>  <p style="text-align: right;">Electric Box Cover</p>

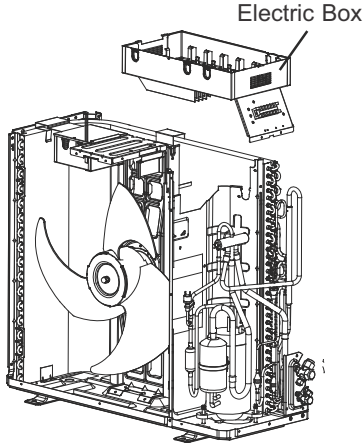
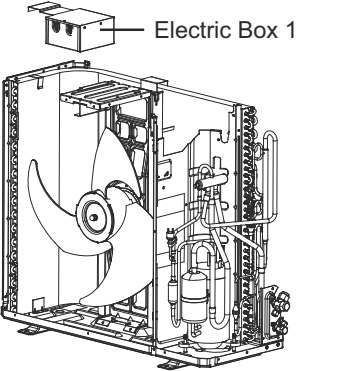
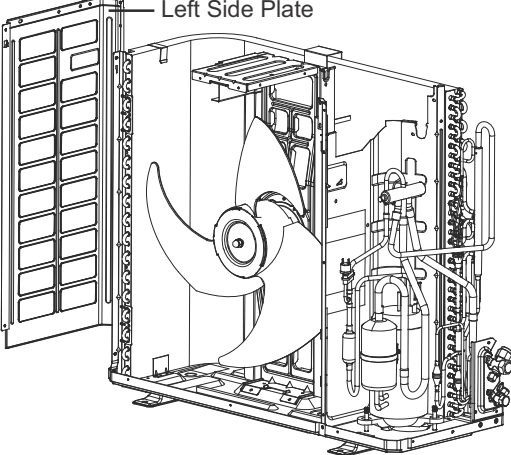
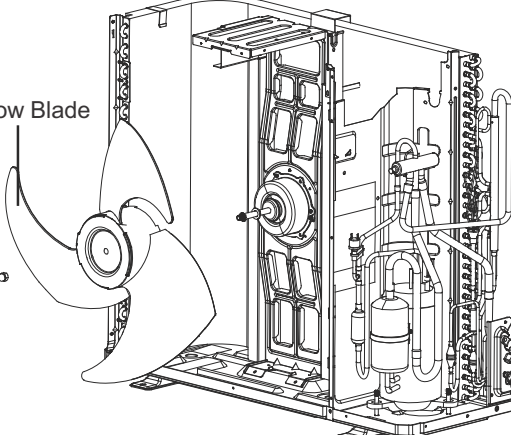
STEPS	PROCEDURES
<p>7. Remove electric box (Continued)</p>	<p>b. Twist off the screws on electric box, cut off the tieline with scissors or pliers, pull out the wiring terminal, pull it upwards to remove the electric box.</p>  <p>Electric Box</p> <p>c. Twist off the screws between electric box 1 and left side plate with screwdriver, pull it upwards to remove the electric box 1.</p>  <p>Electric Box 1</p>
<p>8. Remove left side plate</p>	<p>Twist off the screws connecting the left side plate and chassis with screwdriver, and then remove the left side plate.</p>  <p>Left Side Plate</p>
<p>9. Remove axial flow blade</p>	<p>Twist off the nuts on blade with wrench and then remove the axial flow blade.</p>  <p>Axial Flow Blade</p>

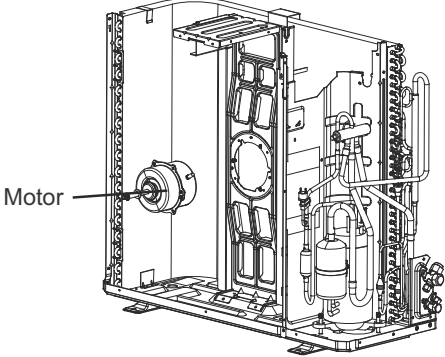
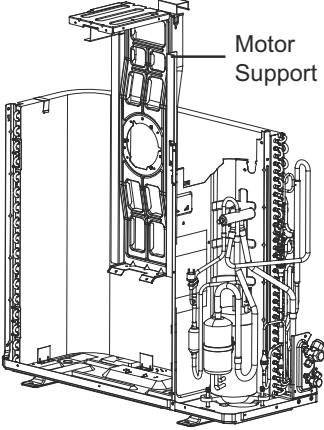
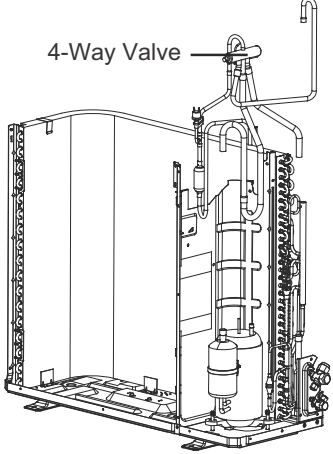
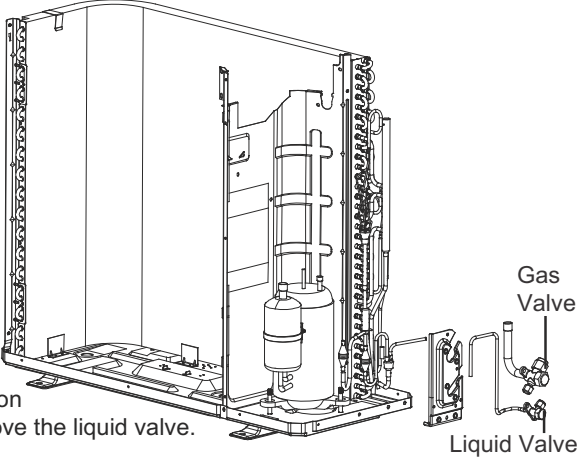
STEPS	PROCEDURES
<p>10. Remove motor and motor support</p>	<p>a. Twist off the tapping screws fixing the motor, pull out the pin of leading wire for motor and then remove the motor.</p>  <p>b. Twist off the tapping screws fixing the motor support, pull it upwards and then remove the motor support.</p> 
<p>11. Remove 4-way valve</p>	<p>Unsolder the pipeline between compressor, condenser, gas and liquid valve, and then remove the 4-way valve. (note: release all refrigerant before unsoldering).</p> 
<p>12. Remove gas valve and liquid valve</p>	<p>Twist off the 2 bolts fixing the valve sub-assy. Unsolder the soldering joint between gas valve and air-return pipe and then remove the gas valve. (note: when unsoldering the soldering joint, wrap the gas valve with wet cloth completely to avoid the damage to valve, and release all refrigerant completely at first). Unsolder the soldering joint between liquid valve and connection pipe of liquid valve, and then remove the liquid valve.</p> 

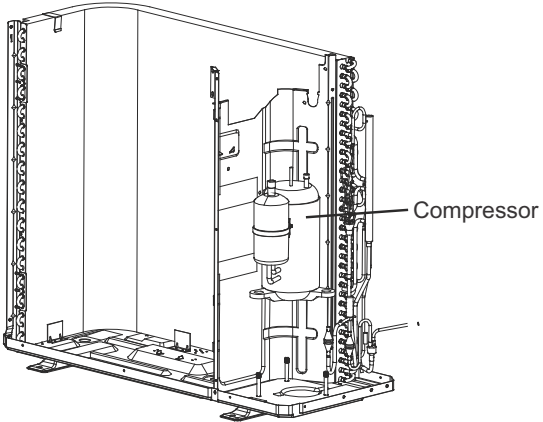
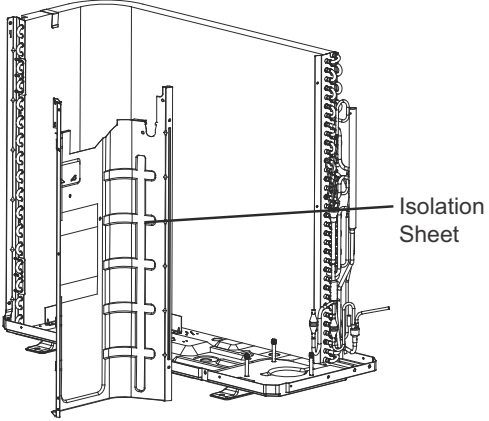
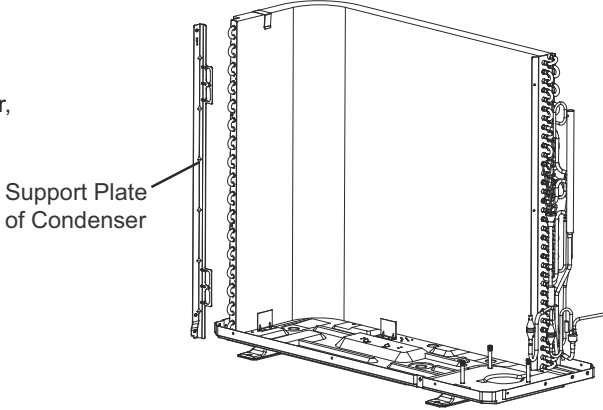
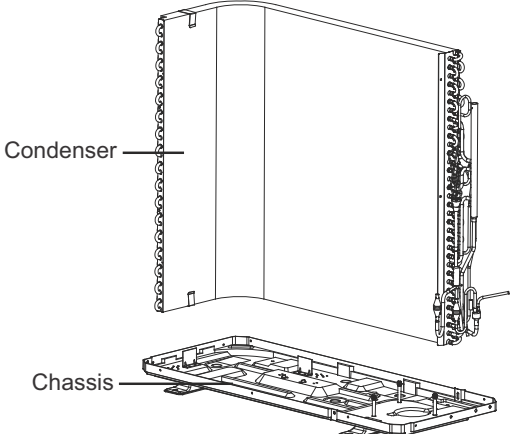
STEPS	PROCEDURES
<p>13. Remove compressor</p>	<p>Twist off the 3 foot nuts on compressor and then remove the compressor.</p> 
<p>14. Remove isolation sheet</p>	<p>Twist off the screws connecting isolation sheet and end plate of condenser and chassis, and then remove the isolation sheet.</p> 
<p>15. Remove support plate of condenser</p>	<p>Twist off the screws connecting the support plate of condenser and condenser with screwdriver, and then remove the support plate of condenser.</p> 
<p>16. Remove chassis and condenser</p>	<p>Pull it upwards to separate the chassis and condenser.</p> 

ACCESSORIES

PART NUMBER	DESCRIPTION
OTHER ACCESSORIES	
S1-DL30510050	Remote Control
S1-DL26150003	Remote Control Holder
S1-DL11200511	Catechin Filter
S1-230-DL16	5/8" Drain Line
MOUNTING ACCESSORIES	
S1-1836-2	PAD,UNIT,ECOPAD,18X36X2 (M50)
S1-ACP1836-2	PAD,UNIT,DURAGRID,18X36X2 (M50)
S1-EL1838-3	PAD,UNIT,ELITE PLASTIC,18X38X3 (M16)
S1-UC1636-2	PAD,UNIT,ULTRALITE,16X36X2 (M20)
S1-UC1636-3	PAD,UNIT,ULTRALITE,16X36X3 (M15)
S1-230-MB14W	BLOCK,MOUNTING,MINISPLIT,14",PK OF 2(M6)
S1-230-MB17W	BLOCK,MOUNTING,MINISPLIT,17",PK OF 2(M6)
S1-230-MB36W	BLOCK,MOUNTING,MINISPLIT,36",PK OF 2(M6)
S1-230-MBCW	CAP,END,MTG BLOCK,MINISPLIT,4/PACK (M25)
S1-WBB300	BRACKET,WALL,MINISPLIT,300-LB
S1-CNG	STAND,CONDENSER
S1-PR-351N-M	RISER,CONDENSER,4"H X 18"L (M20)
S1-NP-R410 10PK	CAP,REFRIG,LOCKING,NOVENT,PINK,R-410
S1-NP-R410 2PK	CAP,REFRIG,LOCKING,NOVENT,PINK,R-410
S1-NP-R410 SDT	SCREWDRIVER/KEY,CAP,REFRIG,LOCKING,R-410
CONDENSATE HANDLING	
S1-ASP-MA-UNI	KIT,PUMP,CONDS,MINISPLIT,100-250V,AQUA
S1-ASP-MAXO-230	KIT,PUMP,CONDS,MINISPLIT,230V,ORANGE
S1-ASP-MLF-UNI	KIT,PUMP,CONDS,MINISPLIT,100-250V,LIME
S1-ASP-MW-UNI	KIT,PUMP,CONDS,MINISPLIT,100-250V,WHITE
S1-CVMINI	PUMP,CONDS,MINISPLIT,120/230V (M6)
S1-IQP-KUBE	PUMP,CONDS,0-15 FT,115V,MINISPLIT (M6)
S1-IQP-KUBE-SHROUD	PUMP,CONDS,0-15 FT,115V,MINI,W/SHRD (M6)
S1-553676	PUMP,CONDS,46",230V,MINISPLIT,TPR (M4)
S1-553712	PUMP,CONDS,29",230V,MSPLIT,EC-OP-K (M4)
S1-EZT-180	TRAP,CONDENSATE,WATERLESS,5/8" (M10)
S1-SS610E	SWITCH,CONDS,MINISPLIT,W/DIAG DISP (M12)
S1-230-DPML	PAN,CONDS,OUTDOOR,MINISPLIT,LARGE
S1-230-DPMM	PAN,CONDS,OUTDOOR,MINISPLIT,MEDIUM
S1-230-DPPL	PAN,CONDS,OUTDOOR,MINISPLIT,LARGE
S1-230-DPPM	PAN,CONDS,OUTDOOR,MINISPLIT,MEDIUM
S1-DH-16S	HOSE,DRAIN,16MM (5/8") X 20' (M5)
S1-230-DL16	LINE,DRAIN,MINISPLIT,5/8" ID X 160'
S1-230-DL20	LINE,DRAIN,MINISPLIT,3/4" ID X 160'
S1-230-DLF16	ADAPTER,DRAIN,MINISPLIT,16MM (M10)
S1-230-DLF18	ADAPTER,DRAIN,MINISPLIT,18MM (M10)
S1-230-DLF20	ADAPTER,DRAIN,MINISPLIT,20MM (M10)
S1-230-DLF25	ADAPTER,DRAIN,MINISPLIT,25MM (M10)
S1-230-DLF32	ADAPTER,DRAIN,MINISPLIT,32MM (M10)
S1-230-DLFY	Y,DRAIN,MINISPLIT (M10)
LINESET COVERS AND FITTINGS	
S1-LDK-122-W	KIT,LINESET COVER,4.5' X 12',WHITE
S1-LDK-92-W	KIT,LINESET COVER,3.5' X 12',WHITE
S1-NFP-75	SLEEVE,WALL,ADJUSTABLE,3"DIA (M10)
S1-230-CP3	CPLG,UNION,SPEEDICHANNEL,3" (M10)
S1-230-CP4	CPLG,UNION,SPEEDICHANNEL,4" (M10)
S1-230-CP6	CPLG,UNION,SPEEDICHANNEL,6" (M10)
S1-230-D3	COVER,LINESET,SPEEDICHANNEL,3" (M6)
S1-230-D4	COVER,LINESET,SPEEDICHANNEL,4" (M6)
S1-230-D6	COVER,LINESET,SPEEDICHANNEL,6" (M5)
S1-230-DC3	CAP,END,SPEEDICHANNEL,3" (M10)
S1-230-DC4	CAP,END,SPEEDICHANNEL,4" (M10)
S1-230-DC6	CAP,END,SPEEDICHANNEL,6" (M10)
S1-230-DCLIP	CLIP,SPEEDICHANNEL,PK OF 50
S1-230-DE3	END,DUCT,SPEEDICHANNEL,3" (M10)
S1-230-DE4	END,DUCT,SPEEDICHANNEL,4" (M10)
S1-230-DE6	END,DUCT,SPEEDICHANNEL,6" (M10)
S1-230-DSCREW	SCREW,SPEEDICHANNEL,PK OF 100
S1-230-EB3	ELBOW,INSIDE,90DEG,SPEEDICHANNEL,3"(M10)
S1-230-EB4	ELBOW,INSIDE,90DEG,SPEEDICHANNEL,4"(M10)
S1-230-EB6	ELBOW,INSIDE,90DEG,SPEEDICHANNEL,6"(M10)

PART NUMBER	DESCRIPTION
S1-230-EIN3	ELBOW,OUTSD,90DEG,SPEEDICHANNEL,3"(M10)
S1-230-EIN4	ELBOW,OUTSD,90DEG,SPEEDICHANNEL,4"(M10)
S1-230-EIN6	ELBOW,OUTSD,90DEG,SPEEDICHANNEL,6"(M10)
S1-230-FB3	BEND,FLAT,90 DEG,SPEEDICHANNEL,3" (M10)
S1-230-FB4	BEND,FLAT,90 DEG,SPEEDICHANNEL,4" (M10)
S1-230-FB453	BEND,FLAT,45 DEG,SPEEDICHANNEL,3" (M10)
S1-230-FB454	BEND,FLAT,45 DEG,SPEEDICHANNEL,4" (M10)
S1-230-FB456	BEND,FLAT,45 DEG,SPEEDICHANNEL,6" (M10)
S1-230-FB6	BEND,FLAT,90 DEG,SPEEDICHANNEL,6" (M10)
S1-230-FJ3	JOINT,FLEX,SPEEDICHANNEL,3" (M10)
S1-230-FJ4	JOINT,FLEX,SPEEDICHANNEL,4" (M10)
S1-230-FR3	ESCUTCH,FLAT,WALL,SPEEDICHANNEL,3" (M10)
S1-230-FR4	ESCUTCH,FLAT,WALL,SPEEDICHANNEL,4" (M10)
S1-230-FR6	ESCUTCH,FLAT,WALL,SPEEDICHANNEL,6" (M10)
S1-230-LFB3	BEND,FLAT,LGRAD,90DEG,SPEEDICHNL,3"(M10)
S1-230-LFB4	BEND,FLAT,LGRAD,90DEG,SPEEDICHNL,4"(M10)
S1-230-LFB6	BEND,FLAT,LGRAD,90DEG,SPEEDICHNL,6"(M10)
S1-230-TC34	CPLG,REDUCER,SPEEDICHANNEL,3"X4" (M10)
S1-230-TC46	CPLG,REDUCER,SPEEDICHANNEL,4"X6" (M10)
S1-230-TJ4	TEE,SPEEDICHANNEL,4" (M10)
S1-230-TJ6	TEE,SPEEDICHANNEL,6" (M10)
S1-230-WC3	CVR,WALL PEN,SPEEDICHANNEL,3" (M10)
S1-230-WC4	CVR,WALL PEN,SPEEDICHANNEL,4" (M10)
S1-230-WC6	CVR,WALL PEN,SPEEDICHANNEL,6" (M10)
S1-230-WR3	ESCUTCHEON,WALL,SPEEDICHANNEL,3" (M10)
S1-230-WR4	ESCUTCHEON,WALL,SPEEDICHANNEL,4" (M10)
S1-230-WR6	ESCUTCHEON,WALL,SPEEDICHANNEL,6" (M10)
S1-230-WS2	SLV,WALL PEN,SPEEDICHANNEL,2-1/2" (M10)
MINISPLIT LINESETS (BOTH LINES INSULATED WITH FLARE NUTS)	
S1-52642437015	LINESET,MINISPLIT,1/4LX3/8SX15',3/8(M8)
S1-52642437020	LINESET,MINISPLIT,1/4LX3/8SX20',3/8(M8)
S1-52642437025	LINESET,MINISPLIT,1/4LX3/8SX25',3/8(M8)
S1-52642437030	LINESET,MINISPLIT,1/4LX3/8SX30',3/8(M8)
S1-52642437035	LINESET,MINISPLIT,1/4LX3/8SX35',3/8(M8)
S1-52642437050	LINESET,MINISPLIT,1/4LX3/8SX50',3/8(M8)
S1-52642438015	LINESET,MINISPLIT,1/4LX1/2SX15',3/8(M8)
S1-52642438020	LINESET,MINISPLIT,1/4LX1/2SX20',3/8(M8)
S1-52642438025	LINESET,MINISPLIT,1/4LX1/2SX25',3/8(M8)
S1-52642438030	LINESET,MINISPLIT,1/4LX1/2SX30',3/8(M8)
S1-52642438035	LINESET,MINISPLIT,1/4LX1/2SX35',3/8(M8)
S1-52642438050	LINESET,MINISPLIT,1/4LX1/2SX50',3/8(M8)
S1-52642439015	LINESET,MINISPLIT,1/4LX5/8SX15',3/8(M8)
S1-52642439020	LINESET,MINISPLIT,1/4LX5/8SX20',3/8(M8)
S1-52642439025	LINESET,MINISPLIT,1/4LX5/8SX25',3/8(M8)
S1-52642439030	LINESET,MINISPLIT,1/4LX5/8SX30',3/8(M8)
S1-52642439035	LINESET,MINISPLIT,1/4LX5/8SX35',3/8(M8)
S1-52642439050	LINESET,MINISPLIT,1/4LX5/8SX50',3/8(M6)
S1-52642440015	LINESET,MINISPLIT,1/4LX3/4SX15',3/8(M8)
S1-52642440020	LINESET,MINISPLIT,1/4LX3/4SX20',3/8(M8)
S1-52642440025	LINESET,MINISPLIT,1/4LX3/4SX25',3/8(M8)
S1-52642440030	LINESET,MINISPLIT,1/4LX3/4SX30',3/8(M8)
S1-52642440035	LINESET,MINISPLIT,1/4LX3/4SX35',3/8(M8)
S1-52642440050	LINESET,MINISPLIT,1/4LX3/4SX50',3/8(M6)
S1-52642441015	LINESET,MINISPLIT,3/8LX5/8SX15',3/8(M8)
S1-52642441020	LINESET,MINISPLIT,3/8LX5/8SX20',3/8(M8)
S1-52642441025	LINESET,MINISPLIT,3/8LX5/8SX25',3/8(M8)
S1-52642441030	LINESET,MINISPLIT,3/8LX5/8SX30',3/8(M8)
S1-52642441035	LINESET,MINISPLIT,3/8LX5/8SX35',3/8(M8)
S1-52642441050	LINESET,MINISPLIT,3/8LX5/8SX50',3/8(M6)
S1-52642442015	LINESET,MINISPLIT,3/8LX3/4SX15',3/8(M8)
S1-52642442020	LINESET,MINISPLIT,3/8LX3/4SX20',3/8(M8)
S1-52642442025	LINESET,MINISPLIT,3/8LX3/4SX25',3/8(M8)
S1-52642442030	LINESET,MINISPLIT,3/8LX3/4SX30',3/8(M8)
S1-52642442035	LINESET,MINISPLIT,3/8LX3/4SX35',3/8(M8)
S1-52642442050	LINESET,MINISPLIT,3/8LX3/4SX50',3/8(M6)
S1-52642443015	LINESET,MINISPLIT,3/8LX7/8SX15',3/8(M8)
S1-52642443025	LINESET,MINISPLIT,3/8LX7/8SX25',3/8INS

Subject to change without notice. Published in U.S.A.
 Copyright © 2014 by Johnson Controls, Inc. All rights reserved.

923178-UTG-B-0114
 Supersedes: 923178-UTG-A-1112

York International Corp.
 5005 York Drive
 Norman, OK 73069