

# Product Data

## Side Discharge AC Models

*For coastal applications where units are installed within one (1) mile of salt water, epoxy coated models are recommended. These models have an 8 week lead time after order.*

4A7L5024N1000A  
4A7L5030N1000A  
4A7L5036N1000A  
4A7L5042N1000A  
4A7L5048N1000A

### Epoxy Coated Model

4A7L5024N1COTA  
4A7L5030N1COTA  
4A7L5036N1COTA  
4A7L5042N1COTA  
4A7L5048N1COTA

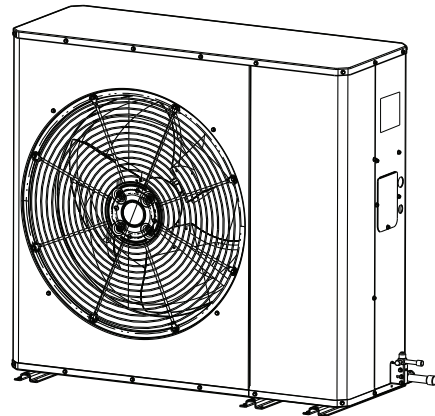

**Note:** "Graphics in this document are for representation only. Actual model may differ in appearance."

## Outline Drawing

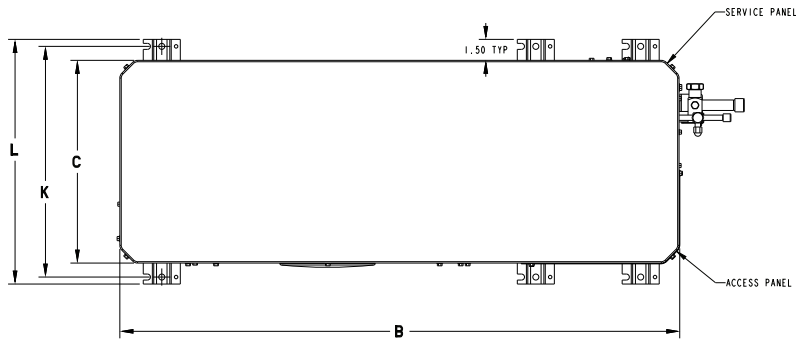

▲ SHOULD BE AT LEAST 152.4 (6 INCHES) FROM WALL AND 609.6 (2 FEET) FROM SURROUNDING SHRUBBERY ON ALL SIDES.

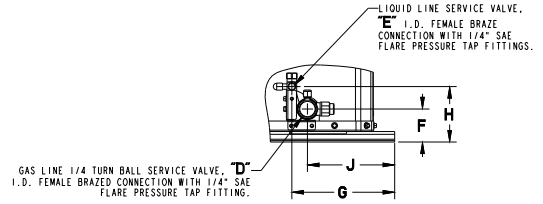

FIGURE 2

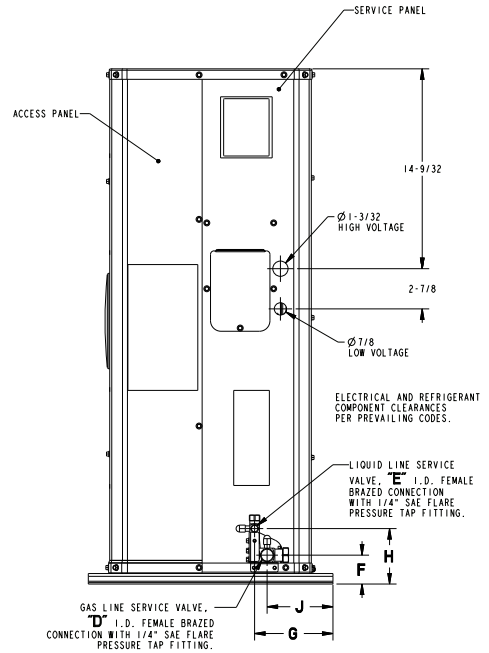
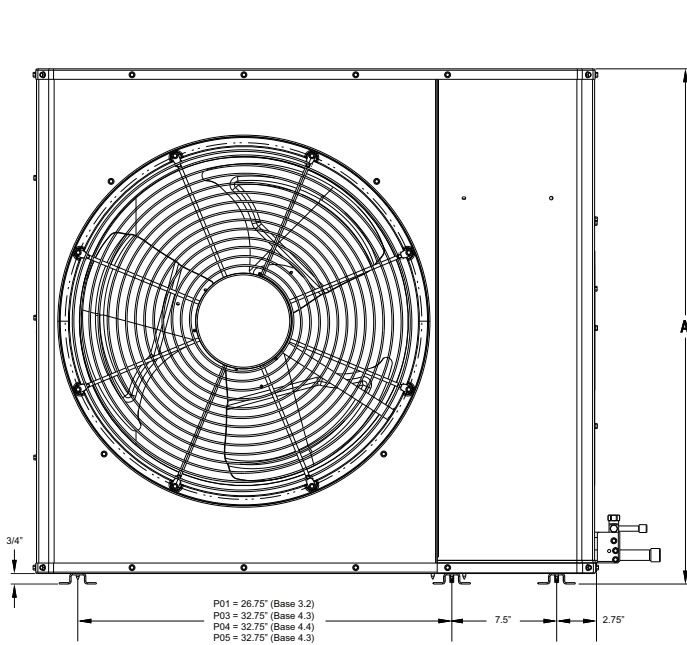

FIGURE 1

DWG. D159818\_Rev D

Model	Base	A	B	C	D	E	F	G	H	J
4A7L5024N	4.3	934 (36-3/4)	1194 (47)	445 (17-1/2)	19 (3/4)	10 (3/8)	53 (2-1/16)	187 (7-11/32)	101 (3-31/32)	159 (6-1/4)
4A7L5030N	4.3	934 (36-3/4)	1194 (47)	445 (17-1/2)	19 (3/4)	10 (3/8)	53 (2-1/16)	187 (7-11/32)	101 (3-31/32)	159 (6-1/4)
4A7L5036N	4.3	934 (36-3/4)	1194 (47)	445 (17-1/2)	22 (7/8)	10 (3/8)	53 (2-1/16)	187 (7-11/32)	101 (3-31/32)	159 (6-1/4)
4A7L5042N	4.4	1086 (42-3/4)	1194 (47)	445 (17-1/2)	22 (7/8)	10 (3/8)	60 (2-3/8)	187 (7-11/32)	101 (3-31/32)	159 (6-1/4)
4A7L5048N	4.4	1086 (42-3/4)	1194 (47)	445 (17-1/2)	22 (7/8)	10 (3/8)	60 (2-3/8)	187 (7-11/32)	101 (3-31/32)	159 (6-1/4)

## Sound Power Level

MODEL	A-Weighted Sound Power Level [dB(A)]	Full Octave Sound Power(dB)							
		63 Hz*	125 Hz	250 Hz	500 Hz	1000 Hz	2000 Hz	4000 Hz	8000 Hz
4A7L5024N	70	72	76	72	68	65	60	52	44
4A7L5030N	70	72	76	72	68	65	60	52	44
4A7L5036N	72	56	76	76	70	66	62	55	48
4A7L5042N	74	75	80	77	70	68	62	54	48
4A7L5048N	74	75	80	77	70	68	62	54	48

Note: Rated in accordance with AHRI Standard 270 \*For Reference Only

MODEL	Sound Pressure [dB(A)]			
	3 ft	5 ft	10 ft	15 ft
4A7L5024N	63	58	52	49
4A7L5030N	63	58	52	49
4A7L5036N	65	60	54	51
4A7L5042N	67	62	56	53
4A7L5048N	67	62	56	53

Note: Rated in accordance with AHRI Standard 275

## Product Specifications

Model No. (a)	4A7L5024N1XXXA	4A7L5030N1XXXA	4A7L5036N1XXXA
HIGH SPEED COOLING CAPACITY@ 80/67-95 (Btuh)	24000	28200	35000
POWER CONNS. – V/PH/HZ (b)	208/230/1/60	208/230/1/60	208/230/1/60
MIN. BRCH. CIR. AMPACITY	15	15	17
BR. CIR. PROT. RTG. – MAX. (AMPS)	25	25	30
COMPRESSOR	DURATION™ - SCROLL	DURATION™ - SCROLL	DURATION™ - SCROLL
RL AMPS – LR AMPS	11.7 – 71.3	11.7 – 71.3	13.1 – 83.1
Outdoor Fan FL AMPS	0.64	0.64	0.64
Fan HP	1/8	1/8	1/8
Fan Dia (inches)	27.3	27.3	27.5
Coil	PLATE FIN	PLATE FIN	PLATE FIN
Refrigerant R-410A	6 LBS., 9 OZ	6 LBS., 9 OZ	6 LBS., 8 OZ
LINE SIZE – IN. O.D. GAS (c)	3/4	3/4	7/8
LINE SIZE – IN. O.D. LIQ.	3/8	3/8	3/8
Charge Spec. Subcooling	8°F	8°F	8°F
Dimensions H x W X D Crated (IN.)	40.88 x 54.5 x 23.0	40.88 x 54.5 x 23.0	40.88 x 54.5 x 23.0
Weight – Shipping (lbs.)	224	224	226
Weight – Net (lbs.)	197	197	199
<b>Optional Accessories:</b>			
Evaporator Defrost Control	AY28X079	AY28X079	AY28X079
Rubber Isolator Kit	BAYISLT101	BAYISLT101	BAYISLT101
Start Kit	BAYKSKT263	BAYKSKT263	BAYKSKT263
Crankcase Heater Kit	BAYCCHT302RES	BAYCCHT302RES	BAYCCHT302RES
Snow Leg Kit 4"	BAYLEGS004	BAYLEGS004	BAYLEGS004
Snow Leg Kit 7"	BAYLEGS007	BAYLEGS007	BAYLEGS007
Scroll Compressor Enclosure	BAYSDEN003	BAYSDEN003	BAYSDEN003
Low Ambient Kit	BAYLOAM107A	BAYLOAM107A	BAYLOAM107A
Wall Mount Kit	BRK05033 (d)	BRK05033 (d)	BRK05033 (d)
Wind Baffle Kit	BAYWIND100	BAYWIND100	BAYWIND101
Refrigerant Lineset (e)			

(a) Certified in accordance with the Unitary Air-conditioner equipment certification program which is based on AHRI standard 210/240.

(b) Calculated in accordance with N.E.C. Only use HACR circuit breakers or fuses.

(c) Standard line lengths – 150', Standard lift – 50' Suction and Liquid line. For Greater lengths and lifts refer to refrigerant piping software Pub#32-3312-0\* (\* denotes latest revision).

(d) Available from Trane Parts

(e) 25, 30, 35, and 50 foot linesets available. For a complete listing of lineset options available from equipment or supply stores, refer to the American Standard Quick Reference Guide.

**Product Specifications**

<b>Model No. (a)</b>	4A7L5042N1XXXA	4A7L5048N1XXXA
HIGH SPEED COOLING CAPACITY@ 80/67-95 (Btuh)	41000	46500
POWER CONNS. – V/PH/HZ (b)	208/230/1/60	208/230/1/60
MIN. BRCH. CIR. AMPACITY	24	24
BR. CIR. PROT. RTG. – MAX. (AMPS)	40	40
COMPRESSOR	DURATION™ - SCROLL	DURATION™ - SCROLL
RL AMPS – LR AMPS	18.3 – 108	18.3 – 108
Outdoor Fan FL AMPS	1.05	1.05
Fan HP	1/5	1/5
Fan Dia (inches)	27.3	27.3
Coil	PLATE FIN	PLATE FIN
Refrigerant R-410A	8 LBS., 5 OZ	8 LBS., 5 OZ
LINE SIZE – IN. O.D. GAS (c)	7/8	7/8
LINE SIZE – IN. O.D. LIQ.	3/8	3/8
Charge Spec. Subcooling	9°F	9°F
Dimensions H x W X D Crated (IN.)	46.88 x 54.5 x 23.0	46.88 x 54.5 x 23.0
Weight – Shipping (lbs.)	266	266
Weight – Net (lbs.)	239	239
<b>Optional Accessories:</b>		
Evaporator Defrost Control	AY28X079	AY28X079
Rubber Isolator Kit	BAYISLT101	BAYISLT101
Start Kit	BAYKSKT263	BAYKSKT263
Crankcase Heater Kit	BAYCCHT301RES	BAYCCHT301RES
Snow Leg Kit 4"	BAYLEGS004	BAYLEGS004
Snow Leg Kit 7"	BAYLEGS007	BAYLEGS007
Scroll Compressor Enclosure	BAYSDEN004	BAYSDEN004
Low Ambient Kit	BAYLOAM107A	BAYLOAM107A
Wall Mount Kit	BRK05033 (d)	BRK05033 (d)
Wind Baffle Kit	BAYWIND101	BAYWIND101
Refrigerant Lineset (e)		

(a) Certified in accordance with the Unitary Air-conditioner equipment certification program which is based on AHRI standard 210/240.

(b) Calculated in accordance with N.E.C. Only use HACR circuit breakers or fuses.

(c) Standard line lengths – 150', Standard lift – 50' Suction and Liquid line. For Greater lengths and lifts refer to refrigerant piping software Pub#32-3312-0\* (\* denotes latest revision).

(d) Available from Trane Parts

(e) 25, 30, 35, and 50 foot linesets available. For a complete listing of lineset options available from equipment or supply stores, refer to the American Standard Quick Reference Guide.

## Accessory Description and Usage

**Evaporation Defrost Control** — SPST Temperature actuated switch that cycles the condenser off as indoor coil reaches freeze-up conditions. Used for low ambient cooling to 30°F with TXV.

**Rubber Isolators** — Six (6) large rubber donuts to isolate condensing unit from transmitting energy into mounting frame or pad. Use on any application where sound transmission needs to be minimized.

**Hard Start Kit** — Start capacitor and relay to assist compressor motor startup. Use in areas with marginal power supply, on long linesets, low ambient conditions, etc.

### AHRI Standard Capacity Rating Conditions

AHRI Standard 210/240 Rating Conditions

1. Cooling 80°F DB, 67°F WB air entering indoor coil, 95°F DB air entering outdoor coil.

**AHRI Standard 270 Rating Conditions** — (Noise rating numbers are determined with the unit in cooling operations.) Standard Noise Rating number is at 95°F outdoor air.

## Model Nomenclature

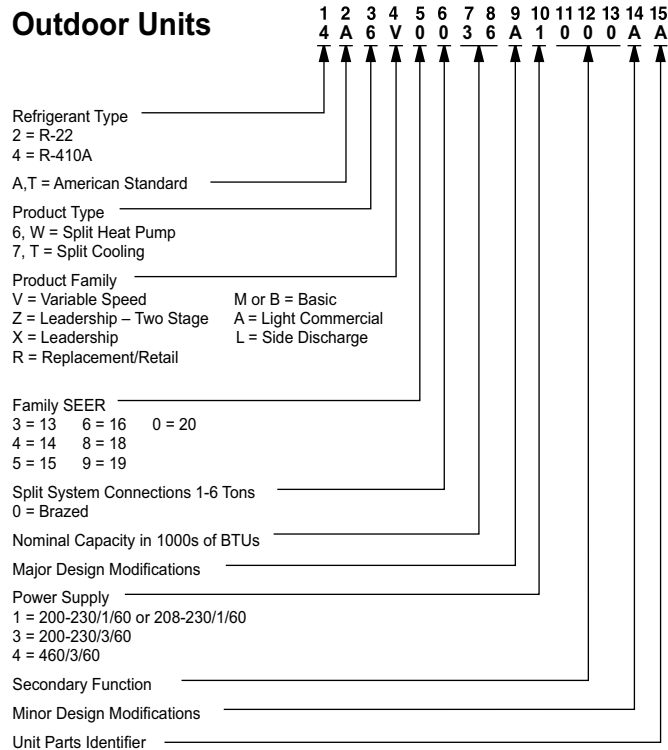

# Wiring

**Figure 1. 2.0, 2.5 and 3.0 Ton Models**

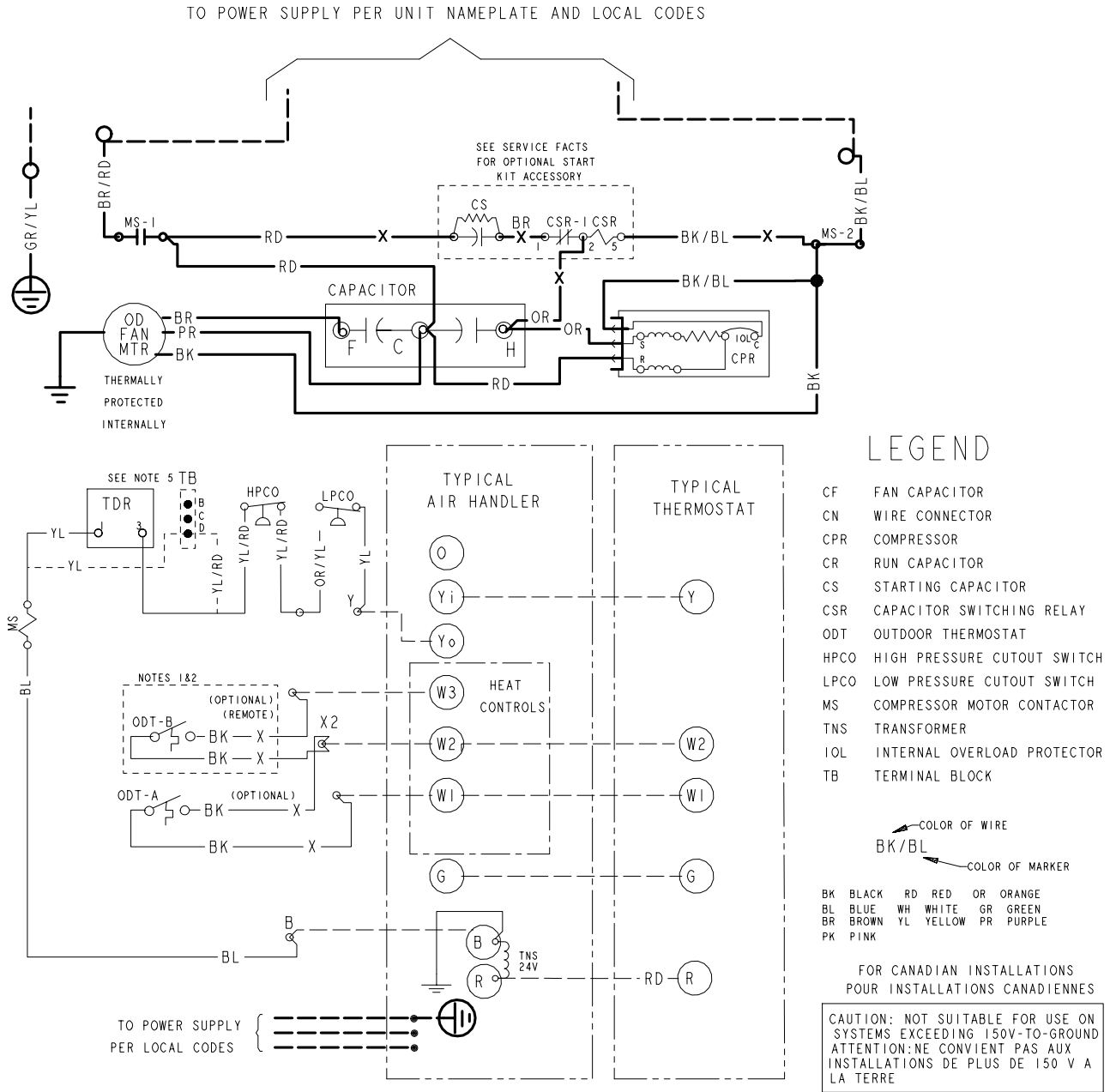

**NOTES:**

1. IF ODT-B IS NOT USED. ADD JUMPER BETWEEN W2 & W3 AT AIR HANDLER. IF USED, ODT-B MUST BE MOUNTED REMOTE OF CONTROL BOX IN AN APPROVED WEATHER PROOF ENCLOSURE.
2. IF ODT-A IS NOT USED. ADD JUMPER BETWEEN W1 & W2 AT AIR HANDLER.
3. LOW VOLTAGE {24 V} FIELD WIRING MUST BE 18 AWG MINIMUM.
4. USE COPPER CONDUCTORS ONLY!
5. USE EITHER TDR OR TB. DO NOT USE BOTH IN ONE MODEL. TB IS ALTERNATE FOR TDR.

PRINTED FROM D161696P01 REV B

**Wiring**

**Figure 2. 2.0, 2.5 and 3.0 Ton Models**

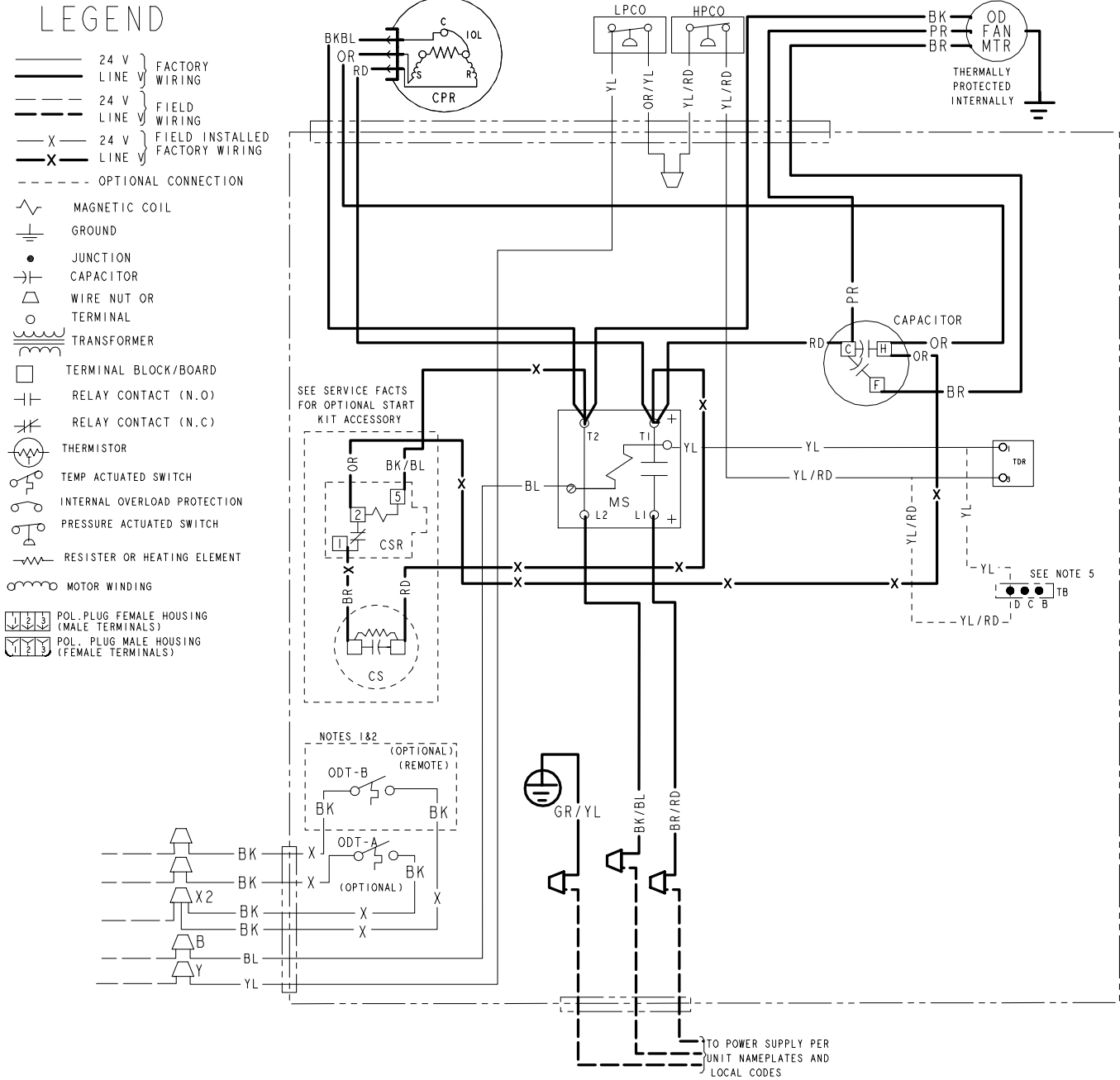

PRINTED FROM DI61696P01 REV B



Wiring

Figure 4. 3.5 and 4.0 Ton Models

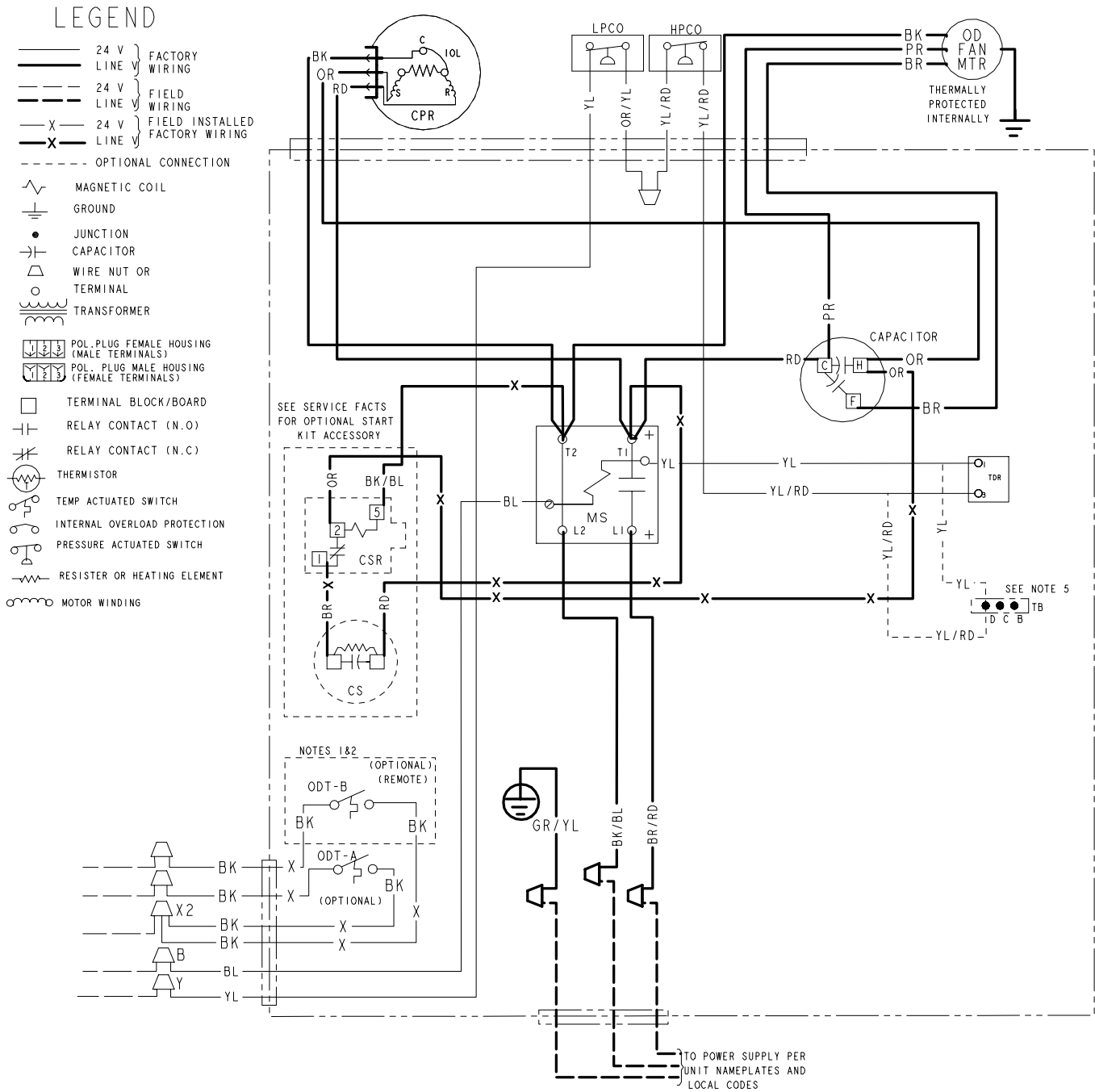

PRINTED FROM DI61795P01 REVA

## Mechanical Specification Options

### **General**

The outdoor condensing units are factory charged with the system charge required for the outdoor condensing unit, ten (10) feet of tested connecting line, and the smallest rated indoor evaporative coil match. This unit is designed to operate at outdoor ambient temperatures as high as 115°F. Cooling capacities are matched with a wide selection of air handlers and furnace coils that are AHRI certified. The unit is certified to UL 1995. Exterior is designed for outdoor application.

### **Casing**

Unit casing is constructed of heavy gauge, galvanized steel and painted with a weather-resistant powder paint finish. The corner panels are prepainted. All panels are subjected to our 1,000 hour salt spray test.

### **Refrigerant Controls**

Refrigeration system controls include condenser fan, compressor contactor and low and high pressure switches. A factory supplied, field installed liquid line drier is standard.

### **Compressor**

The compressor features internal over temperature and pressure protection. Other features include: Centrifugal oil pump and low vibration and noise.

### **Condenser Coil**

The outdoor coil provides low airflow resistance and efficient heat transfer. The coil is protected on all four sides by louvered panels.

### **Low Ambient Cooling**

As manufactured, this system has a cooling capacity to 55°F. The addition of an evaporator defrost control permits operation to 40°F. The addition of an evaporator defrost control with TXV permits low ambient cooling to 30°F.

The addition of the BAYLOAM107A low ambient kit permits ambient cooling to 20°F.

**Thermostats** – Cooling only and heat/cooling (manual and automatic change over). Sub-base to match thermostat and locking thermostat cover.

*American Standard*<sup>®</sup>  
HEATING & AIR CONDITIONING

About American Standard Heating and Air Conditioning  
American Standard has been creating comfortable and affordable living environments for more than a century. For more information, please visit [www.americanstandardair.com](http://www.americanstandardair.com).

---



The AHRI Certified mark indicates company participation in the AHRI Certification program. For verification of individual certified products, go to [ahridirectory.org](http://ahridirectory.org).

The manufacturer has a policy of continuous data improvement and it reserves the right to change design and specifications without notice. We are committed to using environmentally conscious print practices.