

# SAMSUNG

## SYSTEM AIR CONDITIONER

4 WAY CASSETTE SERIES

### INDOOR UNIT

### OUTDOOR UNIT

Model : AC018NN4DCH/AA  
AC024NN4DCH/AA  
AC030NN4DCH/AA  
AC036NN4DCH/AA  
AC042NN4DCH/AA  
AC048NN4DCH/AA

AC018JXADCH/AA  
AC024JXADCH/AA  
AC030JXADCH/AA  
AC036JXADCH/AA  
AC042JXADCH/AA  
AC048JXADCH/AA  
AC030JXSCCH/AA  
AC036JXSCCH/AA

# SERVICE *Manual*

## AIR CONDITIONER



## CONTENTS

1. Precautions
2. Product Specifications
3. Disassembly and Reassembly
4. Troubleshooting
5. PCB Diagram and Parts List
6. Wiring Diagram
7. Reference Sheet

# Contents

<b>1. Precautions .....</b>	<b>1-1</b>
1-1 Precautions for the Service .....	1-1
1-2 Precautions related to static electricity and PL.....	1-1
1-3 Precautions related to product safety.....	1-2
1-4 Other precautions.....	1-2
<b>2. Product Specifications.....</b>	<b>2-1</b>
2-1 The Feature of Product.....	2-1
2-1-1 Features (Wind-Free 4Way CST).....	2-1
2-2 Product Specifications .....	2-5
2-3 Specifications of optional items.....	2-7
2-3-1 Accessories.....	2-7
2-3-2 Filter specifications.....	2-11
<b>3. Disassembly and Reassembly.....</b>	<b>3-1</b>
3-1 Indoor unit.....	3-2
3-2 Outdoor Unit.....	3-7
<b>4. Troubleshooting .....</b>	<b>4-1</b>
4-1 Setting an indoor unit address and installation option .....	4-1
4-1-1 The procedure of setting option.....	4-1
4-1-2 The procedure of setting option.....	4-2
4-1-3 Order for Setting Options (Wired Remote Controller) .....	4-5
4-1-4 Setting an indoor unit installation option (Suitable for the condition of each installation location).....	4-6
4-1-5 Changing a particular option .....	4-8
4-1-6 Option code for each model.....	4-9
4-2 Items to check before diagnostics.....	4-10
4-2-1 Test run mode and View mode .....	4-10
4-2-2 Eco Mode [Power Saving Mode].....	4-12
4-2-3 Four directions cassette type .....	4-13
4-2-4 Outdoor Unit .....	4-14
4-3 Troubleshooting by symptoms.....	4-16
4-3-1 Indoor temperature sensor (open/short).....	4-16
4-3-2 Indoor heat exchanger temperature sensor (open/short).....	4-17
4-3-3 Indoor FAN error.....	4-18
4-3-4 Communication error after finishing Tracking.....	4-19
4-3-5 Indoor unit float sensor error .....	4-20
4-3-6 EEPROM circuit failure .....	4-21
4-3-7 Thermal Fuse Open Error .....	4-22
4-3-8 When the outdoor unit power is not ON - Initial Diagnosis : 3-phase products .....	4-23
4-3-9 Indoor/outdoor communication error (1min.) (Error Code : E202).....	4-27
4-3-11 Outdoor sensor error(Error Code : E221, E231, E251, E320) .....	4-30

# Contents

4-3-12 Reverse phase / Loss phase detection (3-phase outdoor unit) (Error Code : E425 ) .....	4-31
4-3-13 Compressor down due to freezing control (Error Code : E403).....	4-32
4-3-14 Outdoor unit Fan error (Error Code : E458, E475) .....	4-33
4-3-15 Compressor starting error / rotation error (Error Code : E461, E467) .....	4-34
4-3-16 Full current error / PFC over-current error (Error Code : E462, E484).....	4-36
4-3-17 IPM IPM (Over Current) error (Error Code : E464).....	4-37
4-3-18 DC LINK over-current / low-voltage error (Error Code : E466) H/W DC_Link Over Voltage Error (Error Code : E483) AC Input Voltage Sensor Error (Error Code : E488 .....	4-40
4-3-19 Gas leakage error(Error Code : E554) .....	4-41
4-3-20 Pipe blockage error(Error Code : E422) .....	4-43
4-3-21 Smart install mode was not carried out(Error Code : E508 ).....	4-44
4-3-22 Others .....	4-46

## 5. PCB Diagram and Parts List..... 5-1

5-1 Indoor Unit.....	5-1
5-1-1 MAIN PCB.....	5-1
5-1-2 Panel Display PCB.....	5-3
5-2 Outdoor Unit.....	5-4
5-2-1 Main PCB.....	5-4
5-2-2 SUB PCB.....	5-6
5-2-3 MAIN PCB.....	5-7
5-2-4 INVERTER PCB .....	5-8
5-2-5 EMI PCB.....	5-9
5-2-6 Heater PCB .....	5-10

## 6. Wiring Diagram ..... 6-1

6-1 Indoor Unit.....	6-1
6-2 Outdoor unit .....	6-2

## 7. Reference Sheet ..... 7-1

7-1 Index for Model Name .....	7-1
7-1-1 Indoor Unit.....	7-1
7-1-2 Outdoor Unit .....	7-2
7-1-3 Panel .....	7-3
7-2 Refrigerating Cycle Diagram .....	7-4

---

# 1. Precautions

---

## 1-1 Precautions for the Service

---

- **Use the standard parts when replacing the electric parts.**
  - Confirm the model name, rated voltage, rated current of the electric parts.
- **When repairing the equipment, connection of the harness parts must be firm and solid.**
  - A loose connection may cause noise or other malfunction.
- **When assembling and disassembling the equipment while it is laid down, lay it on soft cloth.**
  - Otherwise it may scratch the back of the exterior of the product.
- **Remove dust or dirt completely from the housing block, wiring block and service parts during repair.**
  - This helps prevent the danger of fire caused by tracking or short circuit.
- **Fasten the valve caps of service valves and charging valves of outdoor unit as much as possible using adjustable wrenches.**
- **Check the status of the components' assembly after repair service.**
  - The status must be the same as before the repair service.

## 1-2 Precautions related to static electricity and PL

---

- **The PCB power supply block is susceptible to static electricity. Therefore, care must be taken during repair or measuring while the power is on.**
  - Wear insulation gloves for PCB repair or measuring.
- **Check whether the installation location is at least two meters away from other electronic products such as TV, video, or audio.**
  - Otherwise, the video quality might be degraded or noise might be generated.
- **Do not let end users repair the products themselves.**
  - Unauthorized disassembly might cause electric shock or fire.

## 1-3 Precautions related to product safety

---

- **Do not pull the power cord and do not touch the power plug or aux power switch with wet hands.**
  - It might cause electric shock or fire.
- **A damaged power line or power plug must be replaced to prevent danger.**
- **Do not bend the power cable with excessive force, and do not place a heavy weight on the case as it might damage the cable.**
  - It might cause electric shock or fire.
- **Do not use multiple electric outlets.**
  - This might cause electric shock or fire.
- **Connect the ground terminal when necessary.**
  - You must connect the ground terminal if you determine that there is a danger of electric leakage due to moisture or water.
- **Unplug the power cable or turn off the auxiliary power switch for electric part replacement and repair service.**
  - Otherwise it might cause electric shock.
- **Instruct end users to separate the batteries from the remote controllers and store them separately when the product is not used for long time.**
  - Otherwise leakage from the dry cell may cause problems with the remote controller.

## 1-4 Other precautions

---

- **The pipes should have no leaks during installation, and the compressor must be stopped before removing connecting pipes for pump down work. Operating the compressor while the service valve is open and coolant pipe is not properly connected may cause explosion or injury due to abnormal high pressure created inside the coolant cycle as the air can be absorbed through the pipe.**
- **Pump Down work procedure (When uninstalling the product)**
  - Turn on the air conditioner, select cooling operation, and run the compressor for more than three minutes.
  - Release the high pressure and low pressure valve caps.
  - Close the high pressure valve completely using an L-wrench
  - After about two minutes, close the low pressure valve completely.
  - Stop running the air conditioner.
  - Separate the connecting pipe.

## 2. Product Specifications

### 2-1 The Feature of Product

#### 2-1-1 Features (Wind-Free 4Way CST)

##### ■ Wind-Free Cooling with Micro holes

The Wind Free Air conditioner pushes air out through 15,000 micro holes in the panel, producing a dispersed and gentle flow of air actually defined as "still air" and the key here is all of those holes create a still, cooled air flow that infiltrates the room gently and softly.

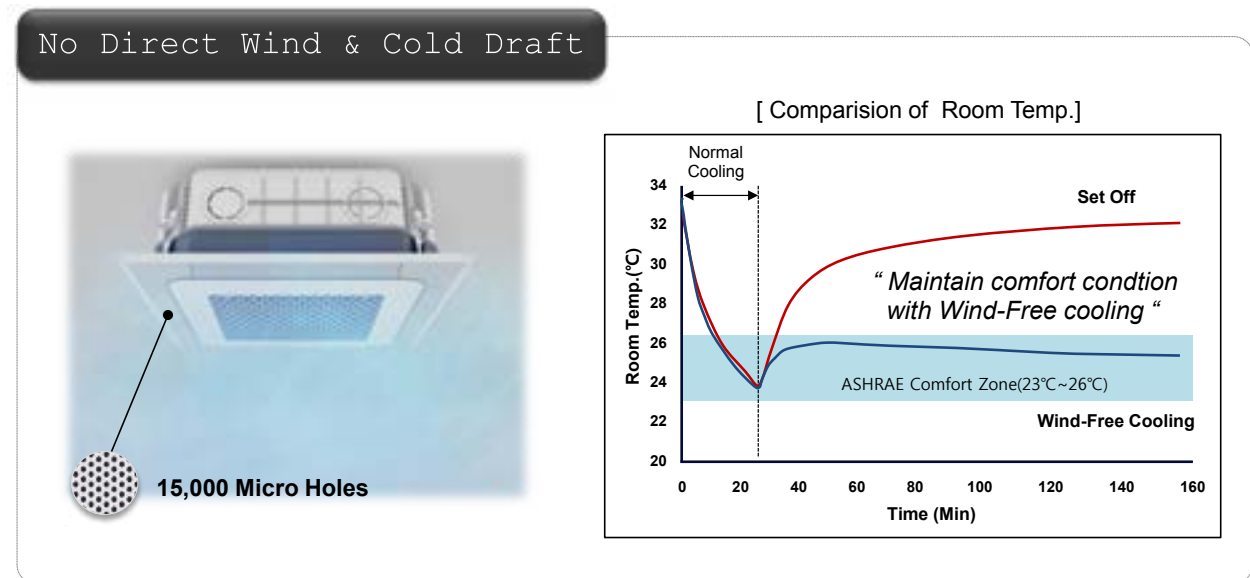

##### ■ Wind-Free Cooling with Micro holes

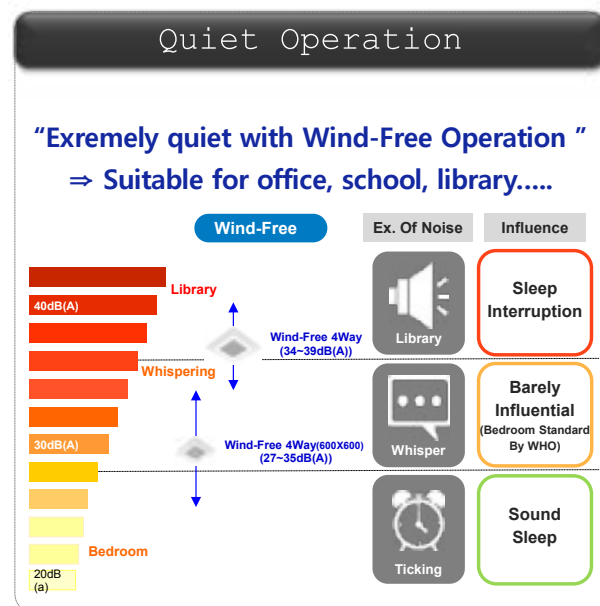

## 2-1-1 Features (Wind-Free 4Way CST) (cont.)

### ■ Big Blade, Long Wind

Big and optimized blades enable wider cooling range.

**Wider Cooling Range**

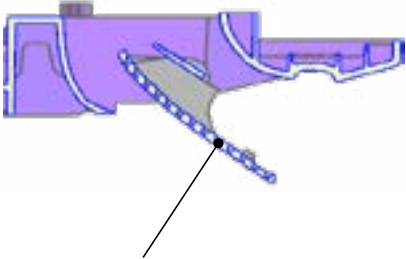

81mm Big Blade (26% ↑)  
Optimized Blade Shape

**Wind-Free 4Way**



5.0m  
Wider Cooling area

**Conventional 4Way**

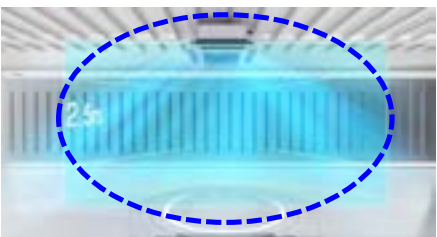

2.4m

### ■ Smart Comfort Operation

Smart comfort operation enable to maintain optimal room condition automatically by detecting not only temperature but also relative humidity.

**Automatic Wind-Free Operation**

If room reaches comfort zone

If room get out of comfort zone



Normal Cooling

Wind-Free Cooling

Normal Cooling

## 2-1-1 Features (Wind-Free 4Way CST) (cont.)

### ■ Easy Installation in 4 Different Ways

Freely install anywhere without worrying about direction. (Body and Panel as well)

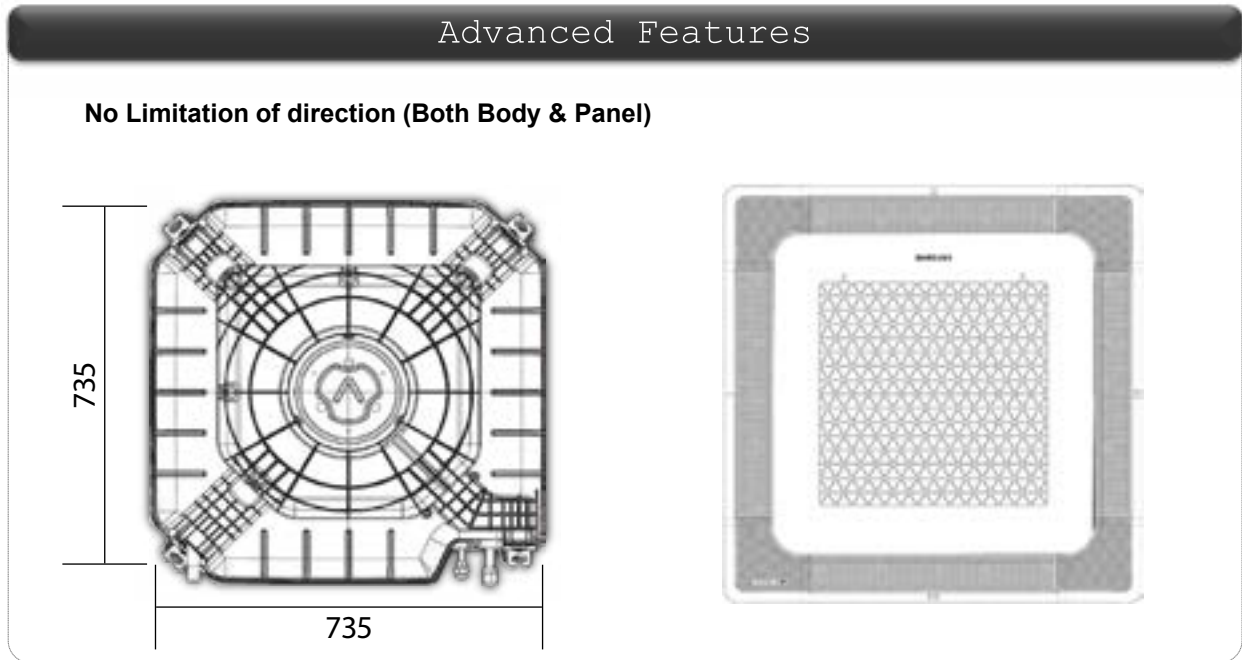

### ■ New Improved Design

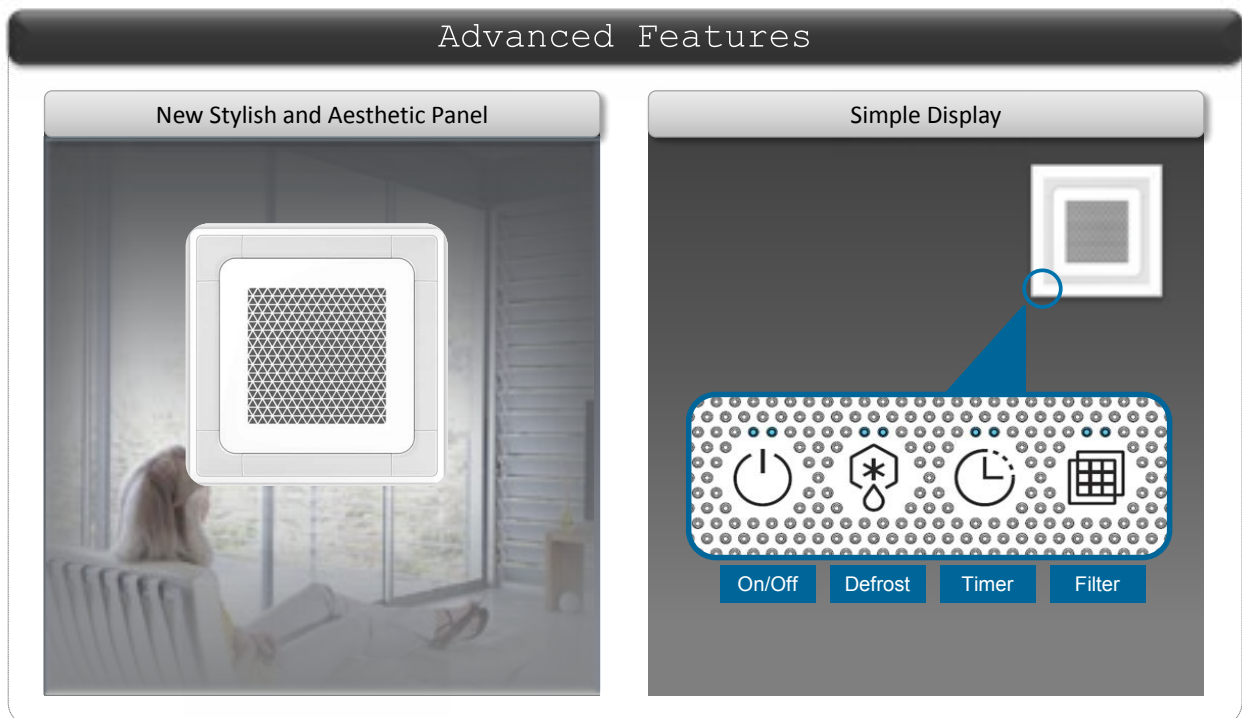



### 2-1-1 Features (Wind-Free 4Way CST) (cont.)

#### ■ ENo Back Flowing Drain Water

Check Valve on the drain pump prevents drain water from reversing  
→ Minimize water gathering in Drain Board to prevent rusting

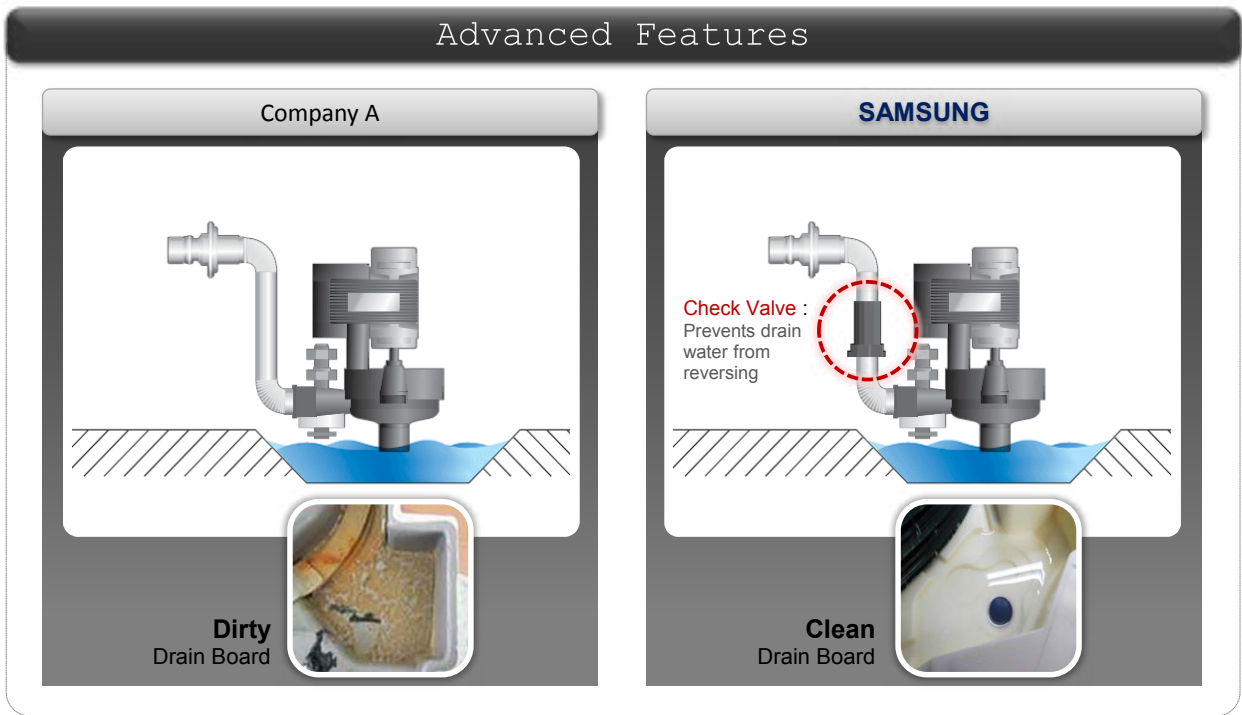





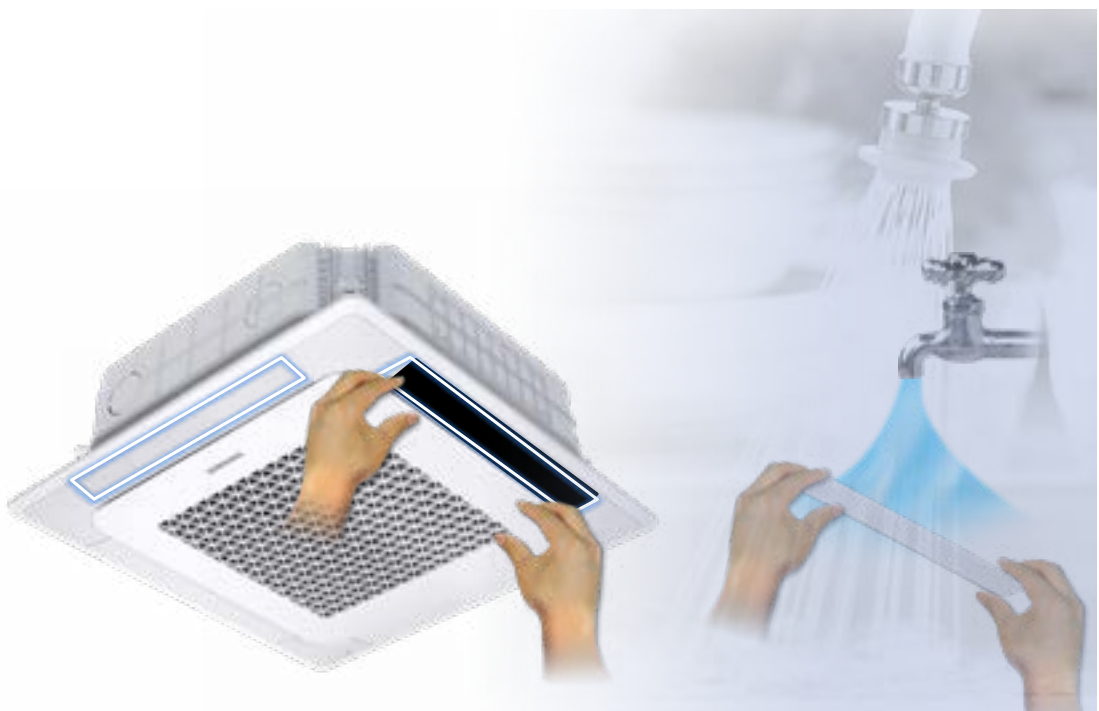

#### ■ Easy Maintenance

##### Easy Air Flow Blade Cleaning



## 2-2 Product Specifications

ITEM		Development Model							
		AC018NN4DCH/AA AC018JXADCH/AA	AC024NN4DCH/AA AC024JXADCH/AA	AC030NN4DCH/AA AC030JXADCH/AA	AC036NN4DCH/AA AC036JXADCH/AA	AC042NN4DCH/AA AC042JXADCH/AA	AC048NN4DCH/AA AC048JXADCH/AA	AC030NN4DCH/AA AC030JXSCCH/AA	AC036NN4DCH/AA AC036JXSCCH/AA
IMAGE	INDOOR UNIT								
	OUTDOOR UNIT								
	REMOTE CONTROLLER								
Performance	Cooling [Btu/h]	5,000/18,000/21,000	7,000/24,000/27,000	9,300/30,000/35,000	14,000/36,000/41,000	16,300/42,000/45,000	18,600/48,000/51,000	13,000/30,000/36,000	14,000/36,000/42,000
	Heating [Btu/h]	3,800/20,000/25,000	5,200/27,000/31,000	9,000/32,000/38,000	11,500/40,000/48,000	13,400/47,000/50,000	15,300/53,000/55,000	11,000/32,000/39,000	12,000/40,000/48,000
Power Consumption	Cooling [W]	350/1,540/2,200	450/2,110/2,500	700/2,890/4,000	930/2,980/3,600	1,080/4,040/4,500	1,240/4,950/5,000	870/2,290/3,200	930/2,790/3,600
	Heating [W]	260/1,600/2,700	380/2,500/3,500	650/3,110/5,500	720/3,480/5,000	840/4,350/5,400	960/5,050/5,700	720/2,440/5,000	720/3,220/5,000
EER/COP	Cooling [Btu/hW]	11.71	11.41	10.41	12.11	10.41	9.71	13.1	12.9
	Heating [Btu/hW]	12.51	10.81	10.31	11.51	10.81	10.51	13.1	12.4
Voltage / Frequency		208~230V/60Hz		208~230V/60Hz		208~230V/60Hz		1Φ, 208-230V/60Hz	
Operating Current	Cooling [A]	2.1/7.1/10.0	2.8/9.8/12.0	4.0/13.4/17.0	4.8/13.8/17.0	5.6/18.7/21.0	6.4/22.9/23.0	4.8/11.0/14.0	4.8/13.4/17.0
	Heating [A]	1.7/7.4/12.0	2.5/11.6/14.5	3.4/14.4/21.8	3.7/16.1/23.0	4.3/20.1/25.0	5.0/23.4/28.0	3.7/11.6/22.5	3.7/15.4/23.0
Noise	Indoor Unit [dBA] (C/H)	42/42	45/45	47/47	50/50	51/51	51/51	47/47	50/50
	Outdoor Unit [dBA] (C/H)	58/58	60/60	60/60	60/60	62/62	62/62	60/62	60/62
Size	Net Dimension (WxDxH)	Indoor Unit [mm] (In)	840*840*204 (33.07*33.07*8.03)	840*840*204 (33.07*33.07*8.03)	840*840*288 (33.07*33.07*11.34)	840*840*288 (33.07*33.07*11.34)	840*840*288 (33.07*33.07*11.34)	840*840*288 (33.07*33.07*11.34)	840*288*840 (33.07*11.34*33.07)
		Outdoor Unit [mm]	880*310*638	940*330*998	940*330*998	940*330*1210	940*330*1210	940*330*1210	940*1420*330
	Shipping Dimension (WxDxH)	Indoor Unit [mm] (In)	898*898*275 (35.35*35.35*10.83)	898*898*275 (35.35*35.35*10.83)	898*898*357 (35.35*35.35*14.06)	898*898*357 (35.35*35.35*14.06)	898*898*357 (35.35*35.35*14.06)	898*898*357 (35.35*35.35*14.06)	898*357*898 (35.35*14.06*35.35)
		Outdoor Unit [mm]	1023*413*730	995*426*1096	995*426*1096	995*426*1388	995*426*1388	995*426*1388	995*1598*426
Weight	Net Weight	Indoor Unit [kg] (lbs)	15(33.07)	15(33.07)	18.5(40.79)	18.5(40.78)	18.5(40.78)	18.5(40.78)	18.5(40.78)
		Outdoor Unit [kg] (lbs)	45(99.21)	64.5(142.20)	70(154.32)	88(194.01)	88(194.01)	88(194.01)	96(211.6)
	Shipping Weight	Indoor Unit [kg] (lbs)	18(39.68)	18(39.68)	22(48.5)	22(48.5)	22(48.5)	22(48.5)	22(48.5)
		Outdoor Unit [kg] (lbs)	48(105.82)	69.5(153.22)	74(163.14)	98(216.05)	98(216.05)	98(216.05)	106(223.69)
Harness Specifications	Indoor Fan Motor	DB31-00578B	DB31-00578B	DB31-00577A	DB31-00577A	DB31-00577A	DB31-00577A	DB31-00577A	DB31-00577A
	Compressor	UG4T150LNBEQ	UG4T200LNFE4	UG8T300LNBJU	UG5T450FUEJX	UG5T450FUEJX	UG5T450FUEJX	UG5T450FUEJX	UG5T450FUEJX
	Outdoor Fan Motor	DB31-00642A	DB31-00579A	DB31-00579A	DB31-00579A	DB31-00579A	DB31-00579A	DB31-00579A	DB31-00579A
Piping	High Pressure	4.1	4.1	4.1	4.1	4.1	4.1	3/8"	
	Low Pressure	1.4	1.4	1.4	1.4	1.4	1.4	5/8"	
PANEL		PC4NUFMAN			PC4NUFMAN			PC4NUFMAN	
Refrigerant Type		R410A							
Factory Charging [g](lbs)		1300(2.87)	2100(4.63)	2600(5.73)	2800(6.17)	2800(6.17)	2800(6.17)	2900(6.39)	
Additional Refrigerant (for every 1m) [g](oz)		10(0.35)	10(0.35)	22(0.78)	33(1.16)	33(1.16)	33(1.16)	25(0.88)	
Basic Piping Length [m](ft)		7.5(24.6)	7.5(24.6)	7.5(24.6)	7.5(24.6)	7.5(24.6)	7.5(24.6)	7.5(24.6)	
Max. Piping Length [m](ft)		30(98)	50(164)	50(164)	75(246)	75(246)	75(246)	75(246)	
Max. Level Difference [m](ft)		20(66)	30(98)	30(98)	30(98)	30(98)	30(98)	30(98)	
Option Code		0140EF-1950D8-27343B-370005	0140EF-1950D8-274750-370005	0140EF-1950E8-275A64-370045	0140EF-195439-276470-370045	0140EF-19544A-277D8C-370045	0140EF-19545B-278CA0-370045	0140EF-1950E8-275A64-370045	0140EF-195439-276470-370045
		020000-100001-200000-300000	020000-100001-200000-300000	020000-100001-200000-300000	020000-100001-200000-300000	020000-100001-200000-300000	020000-100001-200000-300000	020000-100001-200000-300000	020000-100001-200000-300000
		030000-100000-200000-300000	030000-100000-200000-300000	030000-100000-200000-300000	030000-100000-200000-300000	030000-100000-200000-300000	030000-100000-200000-300000	030000-100000-200000-300000	030000-100000-200000-300000

## 2-3 Specifications of optional items

### 2-3-1 Accessories





Item	Description	Code No.	Q'ty	Remark
	ASSY DRAIN-HOSE JOINT	DB94-03287A	1	Indoor Unit
	CABLE-TIE	DB65-10088C	6	
	INSULATION-DRAIN HOSE	DB62-11028A	1	
	INSULATION-HOSE E	DB62-11028H	1	
	INSULATION-HOSE F	DB62-11028J	1	
	HOLDER-HOSE	DB61-06904A	1	
	RUBBER-LEG	AC018JX4DCH : DB67-01533A AC0**JX4DCH : DB73-20134A AC0**JXSCCH : DB73-20134A	4	Outdoor Unit
	CAP-DRAIN	AC018JX4DCH : DB63-10355C AC0**JX4DCH : DB73-20134A AC0**JXSCCH : -	5	
	DRAIN-PLUG OUT	AC018JX4DCH : DB67-20011A AC0**JX4DCH : DB67-00806A AC0**JXSCCH : -	1 2	
	BOLT-FLANGE	6011-003975	4	Panel
	MANUAL INSTALL	DB68-07705A	1	
	CARD-WARRANTY	DB68-02596B	1	

**Accessories (cont.)**

**■ Wireless remote controller (AR-EC03E, AR-EH03E)**



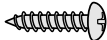



Item	Descriptions	Code-No.	Q'TY	Remark
	Wireless remote controller	DB93-16761K	1	Optional
	Batteries for remote controller (specification: AAA type)	4301-000121	2	
	Remote controller holder	DB61-06087A	1	
	M4×16 screw	6002-000581	2	
	User's manual	DB68-07614A	1	

**Accessories (cont.)****■ Wired remote controller (MWR-WE13N)**

Item	Descriptions	Code-No.	Q'TY	Remark
	Wired remote controller	DB93-11251F	1	Optional
	Cable tie	DB65-10088B	2	
	Cable clamp	DB65-10074E	3	
	M4x16 Screw	6002-000474	5	
	User's manual	DB68-07604A	1	
	Installation Manual	DB68-07608A	1	

**Accessories (cont.)**

■ **Central controller (MCM-A202DN) [Code No. : DB97-22237A]**

Item	Descriptions	Code-No.	Q'TY	Remark
	Central controller	DB93-03425Q	1	Optional
	Cable tie	DB65-10088B	2	
	Cable clamp	DB65-10074E	5	
	M4 X 16 Screw	6002-000474	7	
	User's manual	DB68-03736A	1	
	Installation guide	DB68-03721A	1	

**2-3-2 Filter specifications**

Item	Descriptions	Code-No.	Remark
	Dust filter	DB63-03158A	Basic/ Water wash





### 3. Disassembly and Reassembly



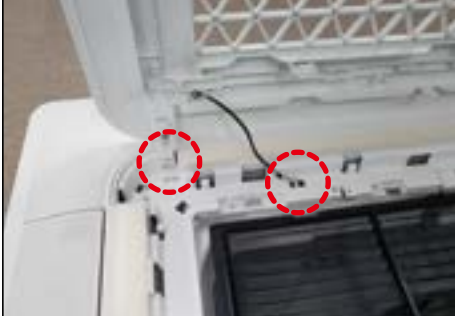

#### ■ Necessary Tools

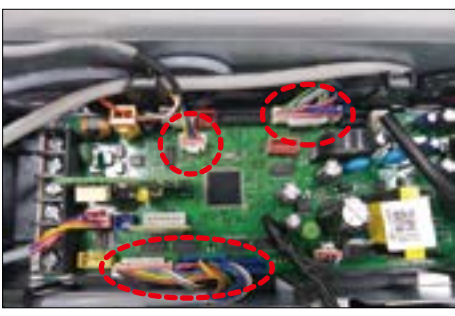



Item	Remarks
+SCREW DRIVER	
Adjustable Wrench (8mm, 10mm, 13mm)	
M6, M8 Hex Wrench	





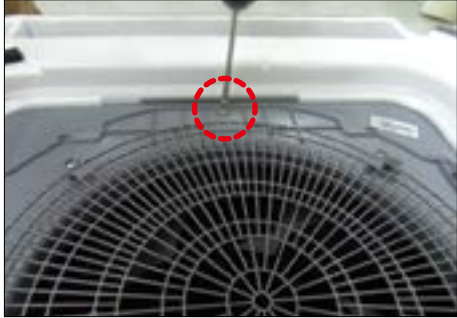





### 3-1 Indoor unit

No	Parts	Procedure	Remark
1	Panel	<ol style="list-style-type: none"> <li>1) Pull two levers below Samsung logo to open the grille.</li> <li>2) Detach the safety clip and white link from the panel.</li> <li>3) Remove the 2 fixed screws to remove the Control-B ox Cover. (Use +Screw Driver)</li> <li>4) Remove the 4 connector wires from the PBA. (Remocon-Receiver, Blade motor and Humidity sensor).</li> <li>5) Detach the 4 corners of the panel using both hands..</li> </ol>	    

No	Parts	Procedure	Remark
		<p>6) Disassemble the bolts that are assembled with the indoor unit at the 4 panel corners.</p> <p>7) Press the Steel Hangers at both sides of the panel inwards, and rotate them 90 degrees to remove it from the indoor unit's Hock. Remove the panel from the indoor unit.</p>	 
2	Control-Box	<p>1) Disconnect the Connector Wire that is connected to the indoor unit's PBA from the PBA.</p> <p>2) Unscrew the 2 fixed screws on both sides of the Control Box, and disassemble the Control Box from the indoor unit. (Use +Screw Driver)</p>	  

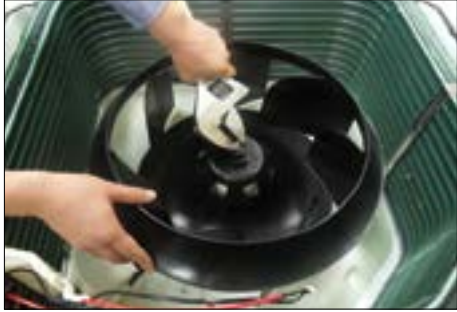



No	Parts	Procedure	Remark
3	Bell-Mouth	<p>1) Unscrew the screw fixed on the Bell-Mouth. (Use +Screw Driver)</p> <p>2) Push the Bell-Mouth in the direction opposite to where it's installed on the Control-Box to remove it.</p>	 
4	Drain Pan	<p>1) Unscrew the screws on the 4 corners of the indoor unit. (Use +Screw Driver)</p> <p>2) Remove the Drain Pan from the indoor unit.</p>	 





No	Parts	Procedure	Remark
5	Drain Pump & Hose	<p>1) Remove the 2 fixed screws and disconnect the white drainage hose from the Drain Pump. (Use +Screw Driver)</p> <p>2) Remove the 2 screws and take the Drain-Hose out from the indoor unit to disassemble the transparent Drain-Hose fixed on the side of the indoor unit. (Use +Screw Driver)</p>	  
6	Evap. Temperature Sensor	<p>1) Use your hand to remove the temperature sensor attached to the Evap Pipe along with the fixing clip.</p>	



No	Parts	Procedure	Remark
7	Fan & Motor	<p>1) Turn the hexangular nut attached to the top of the Fan counterclockwise to remove it. Take the Fan out of the Motor.</p> <p>2) Turn the three hexangular nuts on the Motor counterclockwise to remove the nuts. Take the Motor Wires attached to these three locations out with your hands prior to removing the Motor.</p>	  
8	Evaporator	<p>1) Remove the screws of the 2 Steel Holder Evaps that are used to fix the Heat Exchanger, and then remove it. (Use +Screw Driver)</p> <p>2) Remove the 2 fixing screws of the Partition Evap at the Heat Exchanger's In/Out Pipe. (Use +Screw Driver)</p>	 

## 3-2 Outdoor Unit



## ■ AC018JXADCH



No	Parts	Procedure	Remark
1	common work	<p>1) Loosen 1 pcs screw of cover control, and detach it.</p> <p>2) Loosen 5 pcs screws on both right and left cabinet side edges and to detach the cover-top.</p> <p>3) Loosen 7 screws fixed to disassemble cabi-front, and detach it.</p>	    

No	Parts	Procedure	Remark
	<p><b>common work</b></p>	<p>4) <b>looses 7 screws to disassemble the cabl-right and detach it.</b></p> <p>5) <b>looses 2 screws to disassemble steel bar.</b></p> <p>6) <b>looses 3 screws to disassemble cabl-left.</b></p>	   



No	Parts	Procedure	Remark
2	<b>fan/motor</b>	<p>1) loosen 1 screw as indication and detached the fan.</p> <p>2) loosen 4 pcs motor screws and disconnect the wire between assy control out and motor.</p> <p>3) loosen 2 pcs bracket-motor screw and detach it.</p>	  





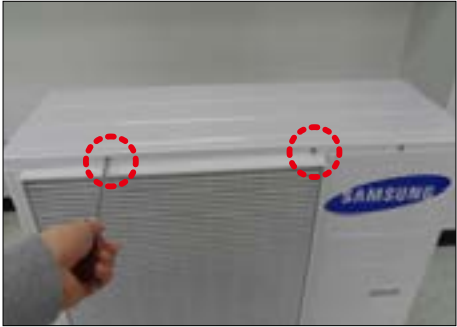

No	Parts	Procedure	Remark
3	assy control out	<ol style="list-style-type: none"> <li>1) loosen fixing 1 screw from cover-control</li> <li>2) detach several connections from assy control out, take out assy control out.</li> </ol>	
4	Heat exchanger	<ol style="list-style-type: none"> <li>1) Release the refrigerant at first</li> <li>2) Loosen fixing screw on both side.</li> <li>3) disassembly the pipes in both inlet and outlet with welding torch.</li> <li>4) detach the heat exchanger.</li> </ol>	



No	Parts	Procedure	Remark
5	compressor	<p>1) disconnect the compressor lead wire.</p> <p>2) disassembly the felt comp stand. loosen the 3 bolts at the bottom of</p>	 

■ AC024/030JXADCH

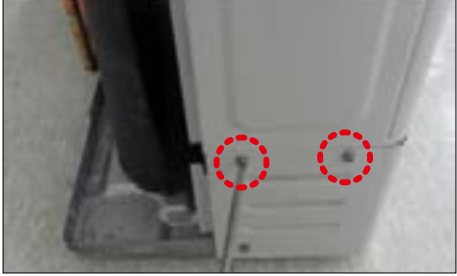

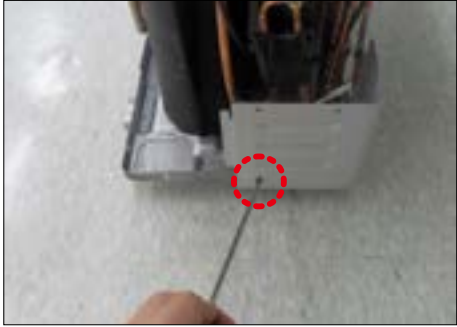
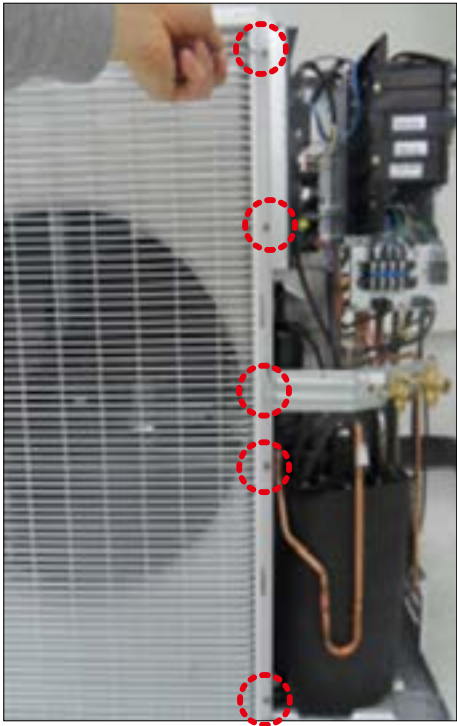
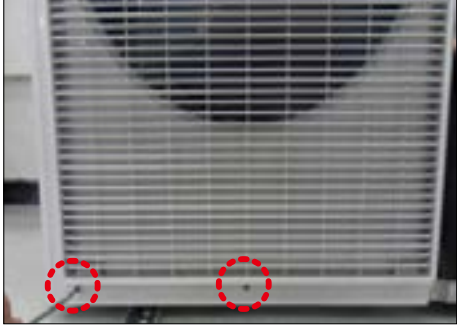
No	Parts	Procedure	Remark
1	Cabi Front RH	<p><b>⚠ You must turn off the Power before disassembly.</b></p> <p>1) Unscrew and remove two mounting screw in the Cabinet Front RH. (Use +Screw Driver)</p>	
2	Cabi Top	<p>1) Unscrew and remove 9 screws on each side of the Cabinet-Top. (Use +Screw Driver)</p>	
3	Cabi Install Front	<p>1) Unscrew and remove 1 screw in the Cabinet-Install Front. (Use +Screw Driver)</p>	

No	Parts	Procedure	Remark
4	Guard Cond	1) Pull the sensor from Guard Cond.  2) Unscrew and remove 4 screws in the Guard Cond. (Use +Screw Driver)	 
5	Cabi Back RH	1) Pull the sensor from Cabi Back RH.  2) Unscrew and remove 4 screws on each side of the Cabinet Back RH. (Use +Screw Driver)	  



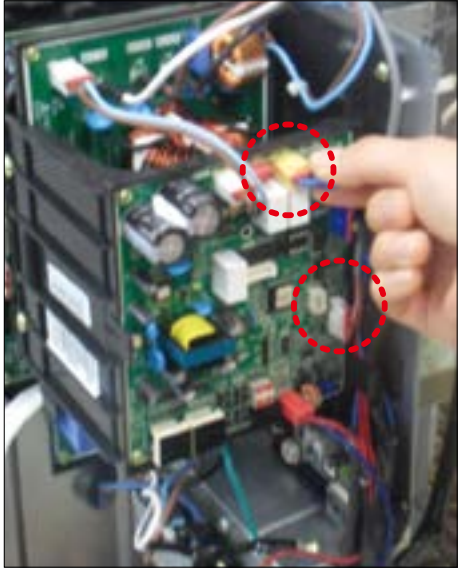
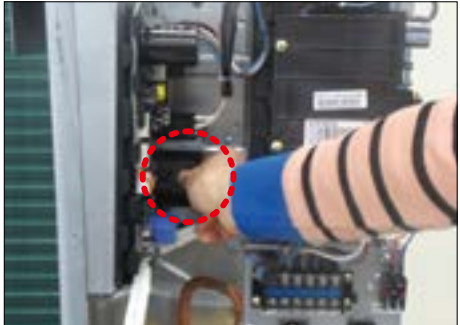

No	Parts	Procedure	Remark
6	Cabi Install Back	1) Unscrew and remove 1 screw in the Cabinet-Install Back. (Use +Screw Driver)	
7	Cabi Front LF	1) Unscrew and remove 10 screws in the Cabinet-Front LF. (Use +Screw Driver)	 



No	Parts	Procedure	Remark
			
8	Fan	<p>1) Turn 1 mounting nuts as shown in the picture and remove it. (Use Adjustable Wrench)</p>	



No	Parts	Procedure	Remark
9	Motor	<ol style="list-style-type: none"> <li>1) Separate the Fan Propeller.</li> <li>2) Unscrew and remove the 4 Motor mounting screws. (Use +Screw Driver)</li>   <li>3) Disconnect the Motor wire From Ass'y Control Out.</li> </ol>	 
10	Bracket Motor	<ol style="list-style-type: none"> <li>1) Unscrew and remove 2 mounting screws in Bracket Motor. (Use +Screw Driver)</li> </ol>	

No	Parts	Procedure	Remark
11	Control Out	<ol style="list-style-type: none"> <li>1) Disconnect 4 Connecters From Ass'y Control Out.</li>   <li>2) Unscrew and remove 1 mounting screw in Control Out. (Use +Screw Driver)</li> <li>3) Separate Ass'y Control Out.</li> </ol>	  

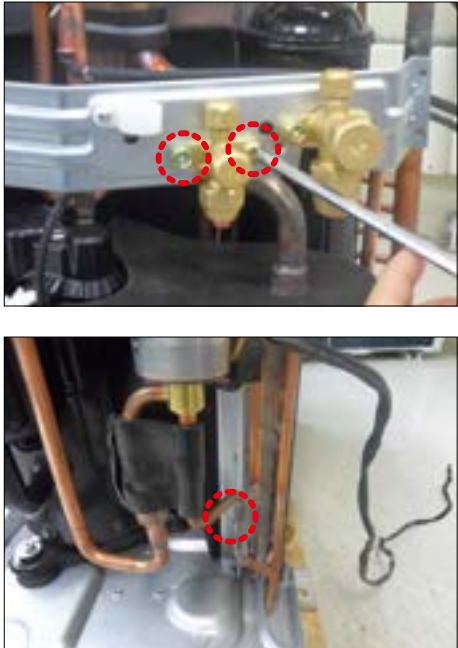





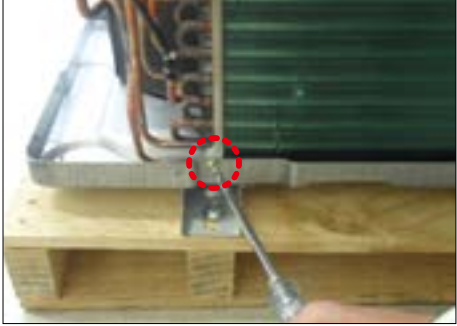

No	Parts	Procedure	Remark
12	Ass'y 4way Valve	<ol style="list-style-type: none"> <li>1) Purge the Coolant first.</li> <li>2) Unscrew and remove 2 mounting screws in muffler.</li> <li>3) Unscrew and remove 2 mounting screws in Service Valve. (Use +Screw Driver)</li> </ol> <ol style="list-style-type: none"> <li>4) Separate the pipe from the Entrance/Exit using a welder.</li> </ol> <p style="color: red;">⚠ When removing the compressor, Heat Exchanger, and Pipe, purge the Coolant inside the Compressor completely and remove the pipe with a welding flame.</p>	   





No	Parts	Procedure	Remark
13	Assy EEV Valve	1) Unscrew and remove 2 mounting screws in Service Valve. (Use +Screw Driver)  2) Separate the pipe from the Entrance/Exit using a welder.	
14	Compressor	1) Unscrew and remove 1 mounting nut in Cover Terminal. (Use Adjustable Wrench)  2) Separate the Compressor Felt Sound.	



No	Parts	Procedure	Remark
		3) As shown in the picture, unscrew and remove 3 mounting screws from the bottom. (Use Adjustable Wrench)	
15	Cond Out	1) Unscrew and remove 3 screws on each side of the Assy Cond Out. (Use +Screw Driver)  2) Separate the Compressor Felt Sound.	  



## ■ AC036/042/048JXADCH

No	Parts	Procedure	Remark
1	Cabi Front RH	<p>⚠ You must turn off the Power before disassembly.</p> <p>1) Unscrew and remove two mounting screw in the Cabinet Front RH. (Use +Screw Driver)</p>	
2	Cabi Top	<p>1) Unscrew and remove 9 screws on each side of the Cabinet-Top. (Use +Screw Driver)</p>	
3	Cabi Install Front	<p>1) Unscrew and remove 1 screw in the Cabinet-Install Front. (Use +Screw Driver)</p>	
4	Guard Cond	<p>1) Pull the sensor from Guard Cond.</p> <p>2) Unscrew and remove 4 screws in the Guard Cond. (Use +Screw Driver)</p>	

No	Parts	Procedure	Remark
5	Cabi Back RH	1) Pull the sensor from Cabi Back RH. 2) Unscrew and remove 4 screws on each side of the Cabinet Back RH. (Use +Screw Driver)	
6	Cabi Install Back	1) Unscrew and remove 1 screw in the Cabinet-Install Back. (Use +Screw Driver)	
7	Cabi Front LF	1) Unscrew and remove 10 screws in the Cabinet-Front LF. (Use +Screw Driver)	





No	Parts	Procedure	Remark
8	Fan	<p>1) Unscrew and remove 3 screws in the Ass'y Fan Propeller-Total. (Use +Screw Driver)</p> <p>2) Remove the Cover from the Fan Propeller</p> <p>3) Turn 2 mounting nuts as shown in the picture and remove it. (Use Adjustable Wrench)</p> <p>⚠ When you assemble the Fan Propeller and the Cover, must check the rib in the hole.</p>	   



No	Parts	Procedure	Remark
9	Motor	1) Separate the Fan Propeller. 2) Unscrew and remove the 8 Motor mounting screws. (Use +Screw Driver) 3) Disconnect the Motor wire From Ass'y Control Out.	
10	Bracket Motor	1) Unscrew and remove 2 mounting screws in Bracket Motor. (Use +Screw Driver)	
11	Heater	1) Unscrew and remove 4 screws on the Base Out. (Use +Screw Driver) 2) Disconnect the heater wire from the Ass'y Control Out.	





No	Parts	Procedure	Remark
12	Control Out	<ol style="list-style-type: none"> <li>1) Disconnect 4 Connecters From Ass'y Control Out.</li> <li>2) Unscrew and remove 1 mounting screw in Control Out. (Use +Screw Driver)</li> <li>3) Separate Ass'y Control Out.</li> </ol>	
13	Assy 4way Valve	<ol style="list-style-type: none"> <li>1) Purge the Coolant first.</li> <li>2) Unscrew and remove 2 mounting screws in Service Valve. (Use +Screw Driver)</li> <li>3) Separate the pipe from the Entrance/Exit using a welder.</li> </ol> <p style="color: red;">⚠ When removing the compressor, Heat Exchanger, and Pipe, purge the Coolant inside the Compressor completely and remove the pipe with a welding flame.</p>	
14	Assy EEV Valve	<ol style="list-style-type: none"> <li>1) Unscrew and remove 2 mounting screws in Service Valve. (Use +Screw Driver)</li> <li>2) Separate the pipe from the Entrance/Exit using a welder.</li> </ol>	









■ AC030/036JXSCCH

No	Parts	Procedure	Remark
1	Cabi Front RH	<p>⚠ You must turn off the Power before disassembly.</p> <p>1) Unscrew and remove two mounting screw in the Cabinet Front RH. (Use +Screw Driver)</p>	
2	Cabi Top	<p>1) Unscrew and remove 9 screws on each side of the Cabinet-Top. (Use +Screw Driver)</p>	
3	Cabi Install Front	<p>1) Unscrew and remove 1 screw in the Cabinet-Install Front. (Use +Screw Driver)</p>	
4	Guard Cond	<p>1) Pull the sensor from Guard Cond.</p> <p>2) Unscrew and remove 4 screws in the Guard Cond. (Use +Screw Driver)</p>	

No	Parts	Procedure	Remark
5	Cabi Back RH	1) Pull the sensor from Cabi Back RH. 2) Unscrew and remove 4 screws on each side of the Cabinet Back RH. (Use +Screw Driver)	
6	Cabi Install Back	1) Unscrew and remove 1 screw in the Cabinet-Install Back. (Use +Screw Driver)	
7	Cabi Front LF	1) Unscrew and remove 10 screws in the Cabinet-Front LF. (Use +Screw Driver)	

No	Parts	Procedure	Remark
8	Fan	<p>1) Unscrew and remove 3 screws in the Ass'y Fan Propeller-Total. (Use +Screw Driver)</p> <p>2) Remove the Cover from the Fan Propeller</p> <p>3) Turn 2 mounting nuts as shown in the picture and remove it. (Use Adjustable Wrench)</p> <p>⚠ When you assemble the Fan Propeller and the Cover, must check the rib in the hole.</p>	   

No	Parts	Procedure	Remark
9	Motor	1) Separate the Fan Propeller. 2) Unscrew and remove the 8 Motor mounting screws. (Use +Screw Driver) 3) Disconnect the Motor wire From Ass'y Control Out.	
10	Bracket Motor	1) Unscrew and remove 2 mounting screws in Bracket Motor. (Use +Screw Driver)	
11	Heater	1) Unscrew and remove 4 screws on the Base Out. (Use +Screw Driver)  2) Disconnect the heater wire from the Ass'y Control Out.	 

No	Parts	Procedure	Remark
12	Control Out	<ol style="list-style-type: none"> <li>1) Disconnect 4 Connecters From Ass'y Control Out.</li> <li>2) Unscrew and remove 1 mounting screw in Control Out. (Use +Screw Driver)</li> <li>3) Separate Ass'y Control Out.</li> </ol>	
13	Assy 4way Valve	<ol style="list-style-type: none"> <li>1) Purge the Coolant first.</li> <li>2) Unscrew and remove 2 mounting screws in Service Valve. (Use +Screw Driver)</li> <li>3) Separate the pipe from the Entrance/Exit using a welder.</li> </ol> <p style="color: red;">⚠ When removing the compressor, Heat Exchanger, and Pipe, purge the Coolant inside the Compressor completely and remove the pipe with a welding flame.</p>	
14	Assy EEV Valve	<ol style="list-style-type: none"> <li>1) Unscrew and remove 2 mounting screws in Service Valve. (Use +Screw Driver)</li> <li>2) Separate the pipe from the Entrance/Exit using a welder.</li> </ol>	

## 4. Troubleshooting

### 4-1 Setting an indoor unit address and installation option

► Set the indoor unit address and installation option with remote controller option.

Set the each option separately since you cannot set the ADDRESS setting and indoor unit installation setting option at the same time. You need to set twice when setting indoor unit address and installation option.

#### 4-1-1 The procedure of setting option

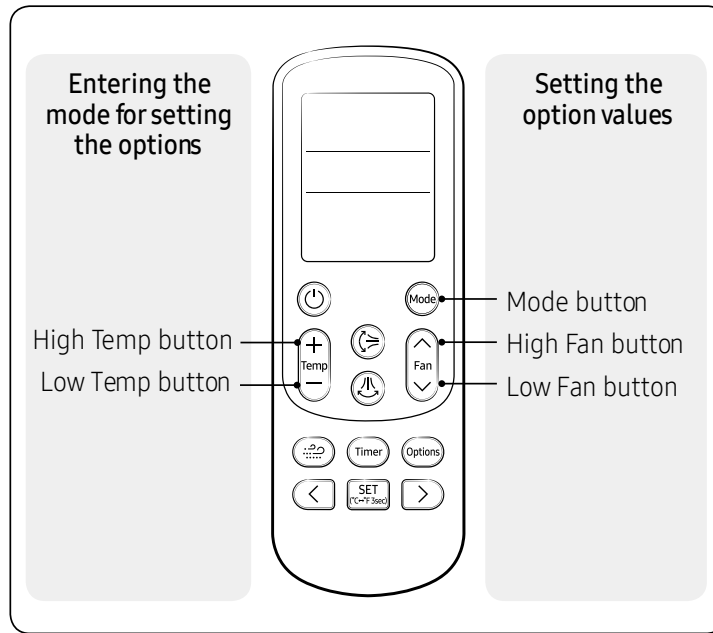

#### Step 1 Entering mode for option setting.

1. Remove batteries from the remote controller.
2. Insert the batteries while you press [+ Temperature] and [- Temperature] button at the same time.
3. Check if you have entered the option setting status. 

#### Step 2 Option setting procedure. (The option setting procedure is the same for other models.)

After entering the option setting status, select the option as listed below.





- Option setting is available from SEG1 to SEG 24.
- SEG1, SEG7, SEG13, SEG19 are not set as page option.
- Set the SEG2~SEG6, SEG8~SEG12 in the ON status and SEG14~18, SEG20~24 in the OFF status.

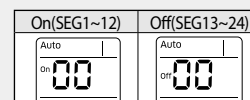



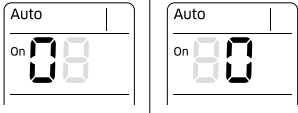
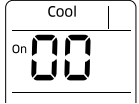
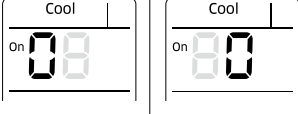
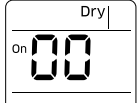
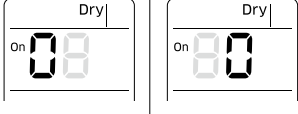
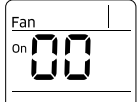
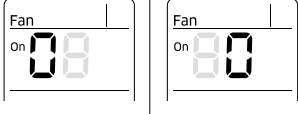

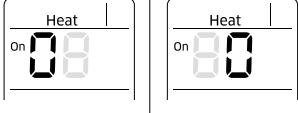
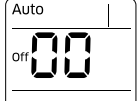
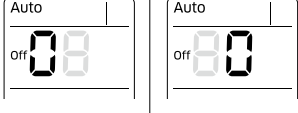



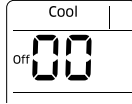



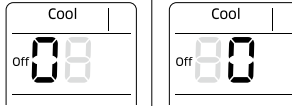

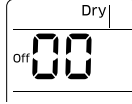



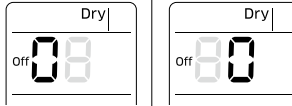

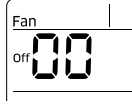
SEG1	SEG2	SEG3	SEG4	SEG5	SEG6	SEG7	SEG8	SEG9	SEG10	SEG11	SEG12
0	X	X	X	X	X	1	X	X	X	X	X
SEG13	SEG14	SEG15	SEG16	SEG17	SEG18	SEG19	SEG20	SEG21	SEG22	SEG23	SEG24
2	X	X	X	X	X	3	X	X	X	X	X

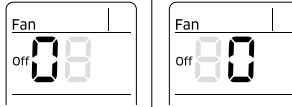

### 4-1-2 The procedure of setting option

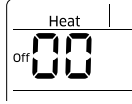
Option setting	Status
<p>1. Setting SEG2, SEG3 option                      Press Low Fan button(∨) to enter SEG2 value.                      Press High Fan button(∧) to enter SEG3 value.                      Each time you press the button, <math>\text{0} \rightarrow \text{1} \rightarrow \dots \text{E} \rightarrow \text{F}</math> will be selected in rotation .</p>	 <p style="text-align: center;">SEG2                      SEG3</p>
<p>2. Setting Cool mode                      (Mode) Press Mode button to be changed to Cool mode in the ON status .</p>	
<p>3. Setting SEG4, SEG5 option                      Press Low Fan button(∨) to enter SEG4 value.                      Press High Fan button(∧) to enter SEG5 value.                      Each time you press the button, <math>\text{0} \rightarrow \text{1} \rightarrow \dots \text{E} \rightarrow \text{F}</math> will be selected in rotation .</p>	 <p style="text-align: center;">SEG4                      SEG5</p>
<p>4. Setting Dry mode                      (Mode) Press Mode button to be changed to DRY mode in the ON status .</p>	
<p>5. Setting SEG6, SEG8 option                      Press Low Fan button(∨) to enter SEG6 value.                      Press High Fan button(∧) to enter SEG8 value.                      Each time you press the button, <math>\text{0} \rightarrow \text{1} \rightarrow \dots \text{E} \rightarrow \text{F}</math> will be selected in rotation .</p>	 <p style="text-align: center;">SEG6                      SEG8</p>
<p>6. Setting Fan mode                      (Mode) Press Mode button to be changed to FAN mode in the ON status .</p>	
<p>7. Setting SEG9, SEG10 option                      Press Low Fan button(∨) to enter SEG9 value.                      Press High Fan button(∧) to enter SEG10 value.                      Each time you press the button, <math>\text{0} \rightarrow \text{1} \rightarrow \dots \text{E} \rightarrow \text{F}</math> will be selected in rotation .</p>	 <p style="text-align: center;">SEG9                      SEG10</p>
<p>8. Setting Heat mode                      (Mode) Press Mode button to be changed to HEAT mode in the ON status .</p>	
<p>9. Setting SEG11, SEG12 option                      Press Low Fan button(∨) to enter SEG11 value.                      Press High Fan button(∧) to enter SEG12 value.                      Each time you press the button, <math>\text{0} \rightarrow \text{1} \rightarrow \dots \text{E} \rightarrow \text{F}</math> will be selected in rotation .</p>	 <p style="text-align: center;">SEG11                      SEG12</p>
<p>10. Setting Auto mode                      (Mode) Press Mode button to be changed to AUTO mode in the OFF status.</p>	
<p>11. Setting SEG14, SEG15 option                      Press Low Fan button(∨) to enter SEG14 value.                      Press High Fan button(∧) to enter SEG15 value.                      Each time you press the button, <math>\text{0} \rightarrow \text{1} \rightarrow \dots \text{E} \rightarrow \text{F}</math> will be selected in rotation.</p>	 <p style="text-align: center;">SEG14                      SEG15</p>

**The procedure of setting option (cont.)**

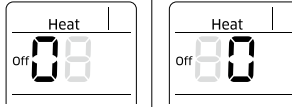
Option setting	Status
<p>12. Setting Cool mode</p> <p> Press Mode button to be change to Cool mode in the OFF status.</p>	
<p>13. Setting SEG16, SEG17 option</p> <p>Press Low Fan button(∨) to enter SEG16 value.</p> <p>Press High Fan button(∧) to enter SEG17 value.</p> <p>Each time you press the button,  →  → ...  →  will be selected in rotation.</p>	 <p style="text-align: center;">SEG16                      SEG17</p>
<p>14. Setting Dry mode</p> <p> Press Mode button to be change to Dry mode in the OFF status.</p>	
<p>15. Setting SEG18, SEG20 option</p> <p>Press Low Fan button(∨) to enter SEG18 value.</p> <p>Press High Fan button(∧) to enter SEG20 value.</p> <p>Each time you press the button,  →  → ...  →  will be selected in rotation.</p>	 <p style="text-align: center;">SEG18                      SEG20</p>
<p>16. Setting Fan mode</p> <p> Press Mode button to be change to Fan mode in the OFF status.</p>	
<p>17. Setting SEG21, SEG22 option</p> <p>Press Low Fan button(∨) to enter SEG21 value.</p> <p>Press High Fan button(∧) to enter SEG22 value.</p> <p>Each time you press the button,  →  → ...  →  will be selected in rotation.</p>	 <p style="text-align: center;">SEG21                      SEG22</p>
<p>18. Setting Heat mode</p> <p> Press Mode button to be change to HEAT mode in the OFF status.</p>	
<p>19. Setting SEG23, SEG24 mode</p> <p>Press Low Fan button(∨) to enter SEG23 value.</p> <p>Press High Fan button(∧) to enter SEG24 value.</p> <p>Each time you press the button,  →  → ...  →  will be selected in rotation.</p>	 <p style="text-align: center;">SEG23                      SEG24</p>



**Step 3** Check the option you have set

After setting option, press  button to check whether the option code you input is correct or not.

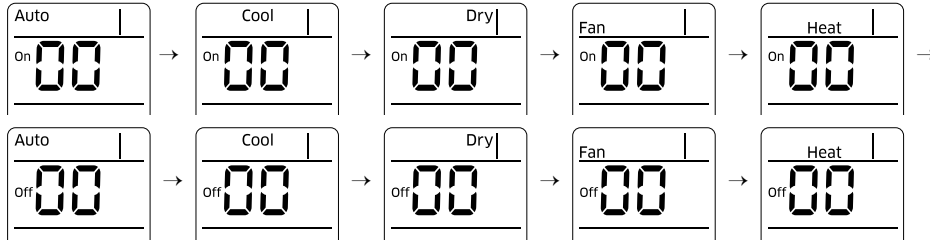

**Step 4** Input option

Press the operation button  with the direction of remote control for set.  
For the correct option setting, you must input the option twice.

**Step 5** Check operation

- 1) Reset the indoor unit by pressing the RESET button of indoor unit or outdoor unit.
- 2) Take the batteries out of the remote controller and insert them again and then press the operation button.

### 4-1-3 Order for Setting Options (Wired Remote Controller)

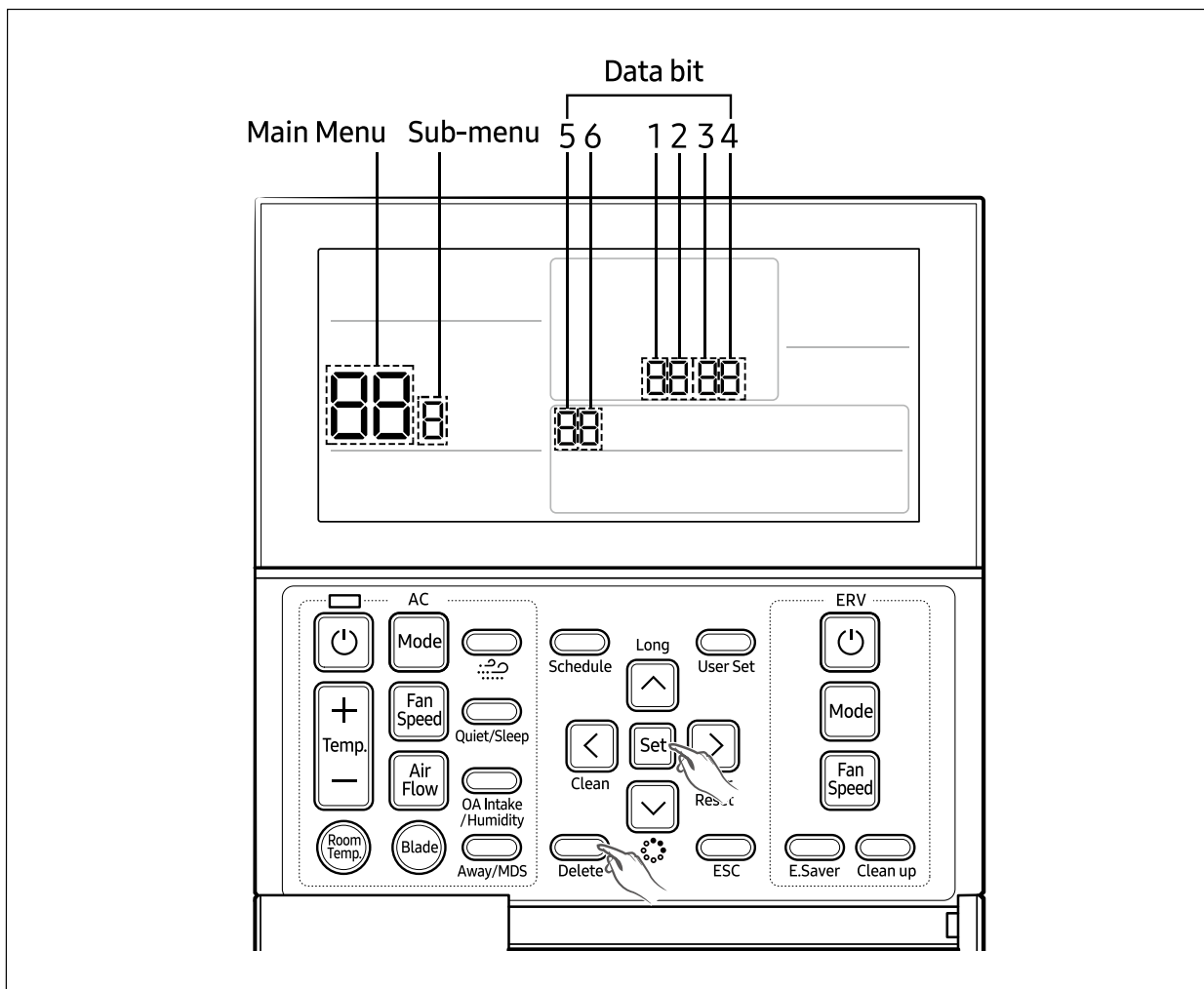

1. **If you want to use the various additional functions for your Wired Remote Controller, press the set and delete buttons at the same time for more than three seconds.**
  - ▶ You will enter the additional function settings, and the [main menu] will be displayed.
  
2. **Refer to the list of additional functions for your Wired Remote Controller on the next page, and select the desired menu.**
  - ▶ Using the [^]/[v] buttons, select a main menu number and press the [>] button to enter the sub-menu setting screen.
  - ▶ Using the [^]/[v] buttons, select a sub-menu number and press the [>] button to enter data setting screen.
  - ▶ When you enter the setting stage, the current setting will be displayed.
  - ▶ Refer to the chart for data settings.
  - ▶ Using the [^]/[v] buttons, select the settings. Press the [>] button to move to the next setting.
  - ▶ Press the **Set** button to save the settings and exit to the sub-menu setting screen.
  - ▶ Press the **Esc** button to exit to normal mode.



NOTE

- While setting the data, you can use the [<]/[>] buttons to set the range of Data bit.
- While configuring the setting, press the **Esc** button to exit to the setting sub-menu without saving your changes.

### 4-1-4 Setting an indoor unit installation option (Suitable for the condition of each installation location)

1. Check whether power is supplied or not.
  - When the indoor unit is not plugged in, there should be additional power supply in the indoor unit.
2. The panel(display ) should be connected to an indoor unit to receive option.
3. Set the installation option according to the installation condition of an air conditioner.
  - The default setting of an indoor unit installation option is 02000-100001-200000-300000.
  - Individual control of a remote controller(SEG20) is the function that controls an indoor unit individually when there is more than one indoor unit.
4. Set the indoor unit option by wireless remote controller.

Option No. : 02XXXX-1XXXX-2XXXX-3XXXX

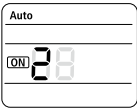
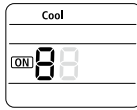
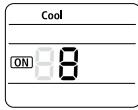
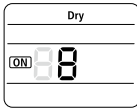
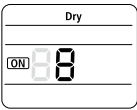
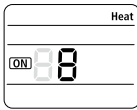
Option	SEG1		SEG2		SEG3	SEG4		SEG5		SEG6	
Explanation	PAGE		MODE		RESERVED	Use of external temperature sensor		Use of central control		Compensation of the fan RPM	
Remote Controller Display											
Indication and Details	Indication	Details	Indication	Details		Indication	Details	Indication	Details	0	Disuse
	0		2			0	Disuse	0	Disuse	1	High-Ceiling Mode
									2	High-Ceiling Kit	
									3	Disuse	
Option	SEG7		SEG8		SEG9	SEG10		SEG11		SEG12	
Explanation	PAGE		Use of drain pump		RESERVED	RESERVED		RESERVED		Dew removal operation in Wind-Free mode	
Remote Controller Display											
Indication and Details	Indication	Details	Indication	Details						Indication	Details
	1		0	Disuse						0	Maintain blade status in Wind-Free mode
			1	Use							
			2	Use + 3minute delay	1	(Default) Cooling Operation by Opening the bla					

Option No. : 02XXXX-1XXXX-2XXXX-3XXXX

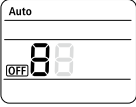
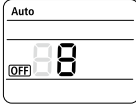
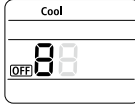
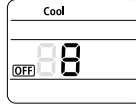
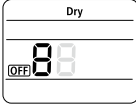
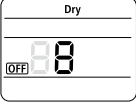
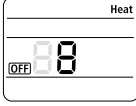
Option	SEG13		SEG14		SEG15		SEG16		SEG17		SEG18		
Explanation	PAGE		Use of external control		Setting the output of external control		S-Plasma ion		Buzzer control		Number of hours using filter		
Remote Controller Display													
Indication and Details	Indication	Details	Indication	Details	Indication	Details	Indication	Details	Indication	Details	Indication	Details	
	2		0	Disuse	0	Thermo on	0	Disuse	0	Use of buzzer	2	1000 Hour	
		1	ON/OFF Control OFF	1	Operation on	1	Use	1	Non use of buzzer	6	2000 Hour		
		2	Control Window ON/OFF Control										
3													
Option	SEG19		SEG20		SEG21		SEG22		SEG23		SEG24		
Explanation	PAGE		Individual control of a remote controller		Heating setting compensation		RESERVED		RESERVED		RESERVED		
Remote Controller Display													
Indication and Details	Indication	Details	Indication	Details	Indication	Details							
	3		0 or 1	Indoor 1	0	Disuse							
		2	Indoor 2	1	2°C								
		3	Indoor 3	2	5°C								
4		Indoor 4											

- Even if you set the Use of drain pump (SEG8) option to 0, it is automatically set to 2 (the drain pump is used with 3 minute delay).
- If you set the Maximum filter usage time (SEG18) option to a value other than 2 and 6, it is automatically set to 2 (1000 hours).
- If you set the Individual control with remote control (SEG20) option to a value other than 0 to 4, it is automatically set to 0 (Indoor 1).

### 4-1-5 Changing a particular option

You can change each digit of set option.

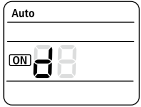
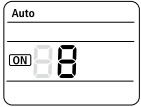
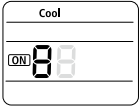
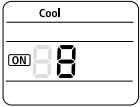
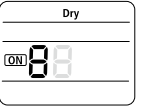
Option	SEG1		SEG2		SEG3		SEG4		SEG5		SEG6	
Explanation	PAGE		MODE		The option mode you want to change		The tens' digit of an option SEG you will change		The unit digit of an option SEG you will change		The changed value	
Remote Controller Display												
Indication and Details	Indication	Details	Indication	Details	Indication	Details	Indication	Details	Indication	Details	Indication	Details
	0		D		Option mode	0~F	Tens' digit of SEG	0~9	Unit digit of SEG	0~9	The changed value	0~F



CAUTION

- When changing a digit of an indoor unit address setting option, set the SEG3 as 'A'.
- When changing a digit of indoor unit installation option, set the SEG3 as '2'.

**Ex) When setting the 'buzzer control' into disuse status.**

Option	SEG1	SEG2	SEG3	SEG4	SEG5	SEG6
Explanation	PAGE	MODE	The option mode you want to change	The tens' digit of an option SEG you will change	The unit digit of an option SEG you will change	The changed value
Indication	0	D	2	1	7	1

### 4-1-6 Option code for each model

■ AC018/024/030/036/042/048NN4DCH/AA

Model	SEG1	SEG2	SEG3	SEG4	SEG5	SEG6	SEG7	SEG8	SEG9	SEG10	SEG11	SEG12
Remocon display												
AC018NN4DCH/AA	0	1	4	0	E	F	1	9	5	0	D	8
AC024NN4DCH/AA	0	1	4	0	E	F	1	9	5	0	D	8
AC030NN4DCH/AA	0	1	4	0	E	F	1	9	5	0	E	8
AC036NN4DCH/AA	0	1	4	0	E	F	1	9	5	4	3	9
AC042NN4DCH/AA	0	1	4	0	E	F	1	9	5	4	4	A
AC048NN4DCH/AA	0	1	4	0	E	F	1	9	5	4	5	B
Model	SEG13	SEG14	SEG15	SEG16	SEG17	SEG18	SEG19	SEG20	SEG21	SEG22	SEG23	SEG24
Remocon display												
AC018NN4DCH/AA	2	7	3	4	3	B	3	7	0	0	0	5
AC024NN4DCH/AA	2	7	4	7	5	0	3	7	0	0	0	5
AC030NN4DCH/AA	2	7	5	A	6	4	3	7	0	0	4	5
AC036NN4DCH/AA	2	7	6	4	7	0	3	7	0	0	4	5
AC042NN4DCH/AA	2	7	7	D	8	C	3	7	0	0	4	5
AC048NN4DCH/AA	2	7	8	C	A	0	3	7	0	0	4	5

## 4-2 Items to check before diagnostics

### 4-2-1 Test run mode and View mode

#### ■ Display Option Key

KEY	Key Operation	7-segment Display
K1	Press once: Heating test run	⎓ 1 BLANK BLANK
	Press twice: Defrost test run	⎓ 3 BLANK BLANK
K2	Press once: Cooling test run	⎓ 2 BLANK BLANK
K3	Reset	
K4	View mode	Refer to View mode display

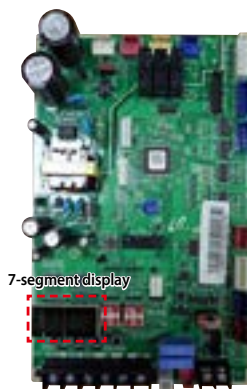

#### ■ View mode display

※ Press the K4 switch to view the information on the system status as follows:

No. of Press	Display content	SEG1	SEG2	SEG3	SEG4	Unit
1	Order frequency	1	Three digits	Two digits	One digit	Hz
2	Current frequency	2	Three digits	Two digits	One digit	Hz
3	Number of indoor units	3	Three digits	Two digits	One digit	Unit
4	Out sensor	4	+/-	Two digits	One digit	°C
5	Discharge sensor	5	Three digits	Two digits	One digit	°C
6	Eva-Mid sensor	6	+/-	Two digits	One digit	°C
7	Cond sensor	7	+/-	Two digits	One digit	°C
8	Current	8	Two digits	One digit	First decimal	°C
9	Fan RPM	9	Four digits	Three digits	Two digits	rpm
10	Target discharge temperature	A	Three digits	Two digits	One digit	°C
11	EEV	B	Three digits	Two digits	One digit	step
12	Total indoor unit capacity	C	Two digits	One digit	First decimal	kW
13	Protection control	D	0: Cooling 1: Heating	Protection control 0: no protection control 1: freezing 2: non-stop defrosting 3: overload 4: discharge 5: under-current	Frequency state 0: Normal 1: Hold 2: Down 3: Up_limit 4: Down_limit	-
14	Heatproof plate temperature	E	Three digits	Two digits	One digit	-
15	S/W check	F	-	-	-	-

Ver.1 ( Long Press once)	Main MICOM version	Year (Hex)	Month (Hex)	Date (Two digits)	Date (One digit)
Ver.2 ( Short press once after Ver.1)	Inverter MICOM version	Year (Hex)	Month (Hex)	Date (Two digits)	Date (One digit)
Ver.3 ( Short press once after Ver.2)	E2P version	Year (Hex)	Month (Hex)	Date (Two digits)	Date (One digit)

※ Press the K4 button long (Main MICOM version) → Press once more shortly → Press shortly one more time (E2P version)

**Test run mode and view mode (cont.)**

**■ DIP Switch Options**

	ON	OFF															
K5	Set an auto address.	Set a manual address.															
K6	Snowdrift prevention control not used.	Snowdrift prevention control used.															
K7	<table border="1"> <thead> <tr> <th>K7</th> <th>K8</th> <th></th> </tr> </thead> <tbody> <tr> <td>ON</td> <td>ON</td> <td>Silent control not used</td> </tr> <tr> <td>ON</td> <td>OFF</td> <td>Silent control used Step_1</td> </tr> <tr> <td>OFF</td> <td>ON</td> <td>Silent control used Step_2</td> </tr> <tr> <td>OFF</td> <td>OFF</td> <td>Silent control used Step_3</td> </tr> </tbody> </table>		K7	K8		ON	ON	Silent control not used	ON	OFF	Silent control used Step_1	OFF	ON	Silent control used Step_2	OFF	OFF	Silent control used Step_3
K7	K8																
ON	ON	Silent control not used															
ON	OFF	Silent control used Step_1															
OFF	ON	Silent control used Step_2															
OFF	OFF	Silent control used Step_3															
K8																	
K9	Auto silent mode	Manual silent mode															



### 4-2-2 Eco Mode [Power Saving Mode]

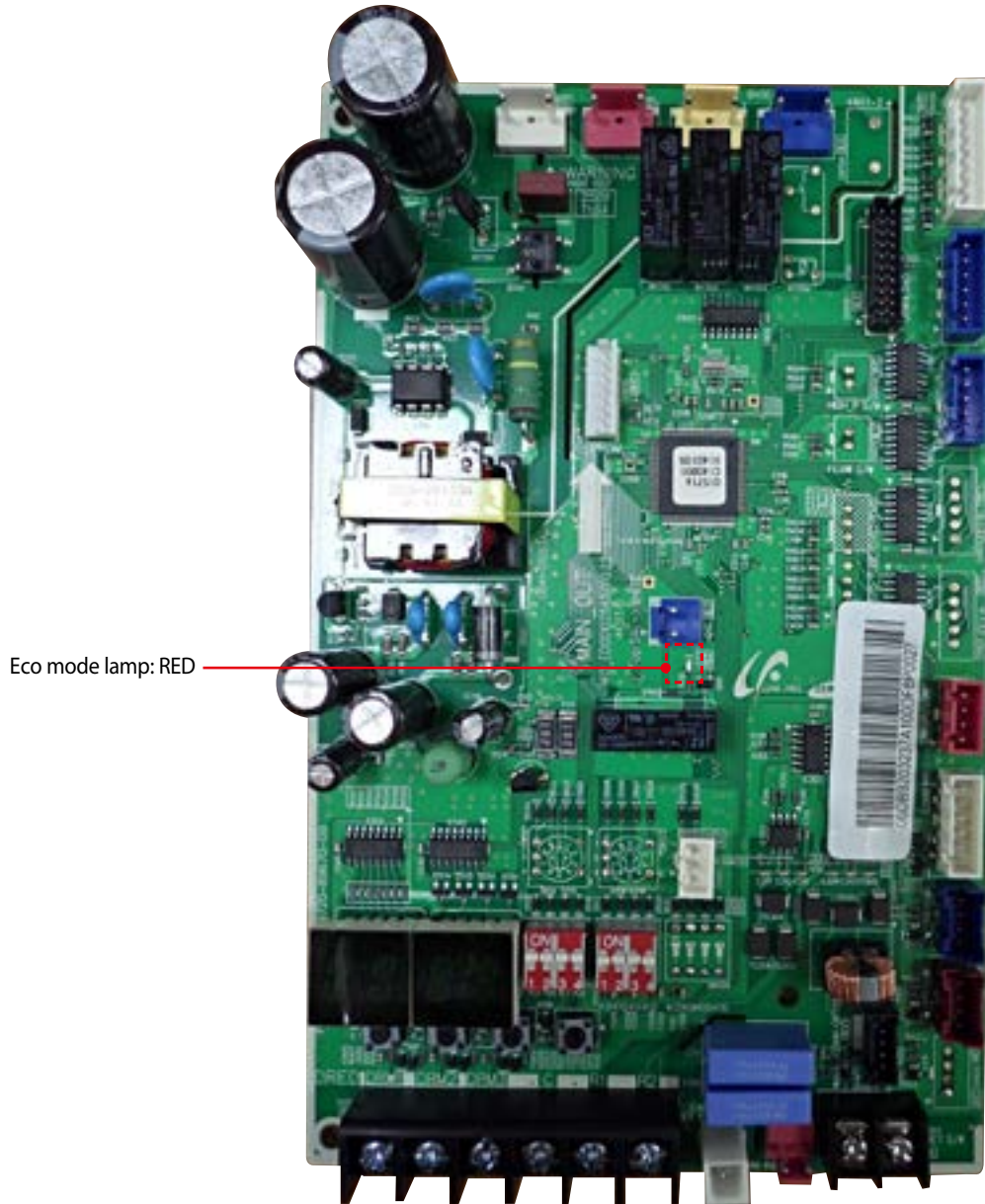

Mode	Display				Eco Mode Lamp
	Segment 1	Segment 2	Segment 3	Segment 4	RED
Eco Mode	BLANK	BLANK	BLANK	BLANK	On
Eco Mode Exit	Press K3 to go out from the eco mode. At the driving signal or test run (cooling/heating) of the user, the mode is released.				Off

### 4-2-3 Four directions cassette type

Error Mode				Cause	Measures	Product operation with error			Diagnosis method
Operation	Defrost	Timer	Filter			Outdoor heat exchanger compressor	Outdoor heat exchanger fan	Indoor heat exchanger fan	
●	X	X	X	Power reset	-	operation-off	operation-off	operation-off	-
X	●	X	X	Error of room temperature sensor in the indoor unit (Open/Short)	<ul style="list-style-type: none"> <li>• Check indoor temperature sensor connection.</li> <li>• Check indoor temperature sensor's resistance value to see if it's short/open.</li> </ul>	operation-off	operation-off	operation-off	-
●	●	X	X	Error of heat exchanger IN/OUT sensor in the indoor unit (Open/Short)	<ul style="list-style-type: none"> <li>• Check EVA IN/OUT sensor connection.</li> <li>• Check EVA IN/OUT sensor's resistance value to see if it's short/open.</li> </ul>	operation-off	operation-off	operation-off	-
X	X	●	X	Error of fan motor in the indoor unit	<ul style="list-style-type: none"> <li>• Check the connection of motor connector</li> <li>• Check the speed of the motor fan</li> </ul>	operation-off	operation-off	operation-off	-
●	X	●	X	Error of the outdoor temperature sensor Error of the condensor temperature sensor Error of the discharge temperature sensor	<ul style="list-style-type: none"> <li>• Check indoor temperature sensor connection.</li> <li>• Check indoor temperature sensor's resistance value to see if it's short/open.</li> </ul>	operation-off	operation-off	operation-off	-
X	●	●	X	No communication for 2 minutes between indoor and outdoor unit (communication error for more than 2 minutes)	<ul style="list-style-type: none"> <li>• Check connection between indoor and outdoor heat exchangers' communication cables</li> </ul>	operation-off	operation-off	operation-off	-
X	●	●	●	Error of outdoor unit	<ul style="list-style-type: none"> <li>• Check error occurred with outdoor heat exchanger.</li> <li>• TERMINAL Block thermal FUSE error.(OPEN)</li> </ul>	operation-off	operation-off	operation-off	-
X	X	●	●	Detection of the float switch	<ul style="list-style-type: none"> <li>• Check float switch connection.</li> <li>• Check whether the drain has been filled with water.</li> </ul>	operation-off	operation-off	operation-off	-
●	●	●	●	EEPROM error EEPROM option error	<ul style="list-style-type: none"> <li>• Check if there is damage with EEPROM component.</li> <li>• Check the indoor model to set the options.</li> <li>• Inspection for match between indoor and outdoor machine models</li> </ul>	operation-off	operation-off	operation-off	-
●	X	●	●	Outdoor valve clogging error.	<ul style="list-style-type: none"> <li>• High pressure check valve clogging.</li> </ul>	operation-off	operation-off	operation-off	-
●	X	X	●	MDS (Motion Detecting Sensor) Error	<ul style="list-style-type: none"> <li>• Check MDS</li> </ul>	-	-	-	-
●	●	X	●	Error due to connecting outdoor units that do not support the Wind-Free function	<ul style="list-style-type: none"> <li>• Check outdoor main PBA S/W</li> <li>• Check outdoor EEPROM</li> </ul>	-	-	-	-

○ : On   ● : Blink   X : Off

### 4-2-4 Outdoor Unit

No.	Error Code	Meaning	Remarks
1	E108	Error due to duplicated communication address	Check on repeated indoor unit main address
2	E121	Error on room temperature sensor of indoor unit (Short or Open)	Indoor unit Room Thermistor Open/Short
3	E122	Error on EVA IN sensor of indoor unit (Short or Open)	Indoor unit EVA_IN Thermistor Open/Short
4	E123	Error on EVA OUT sensor of indoor unit (Short or Open)	Indoor unit EVA_OUT Thermistor Open/Short
5	E153	Error on float switch (2nd detection)	Indoor unit Float Switch Open/Short Drain Pump operation Check
6	E154	Indoor fan error	Check on indoor unit indoor Fan operation
7	E164	Error due to connecting outdoor units that do not support the Wind-Free function	Check outdoor main PBA S/W, Check outdoor EEPROM data
8	E198	Error on thermal fuse of indoor unit (Open)	Thermal Fuse Open Check of indoor unit Terminal Block
9	E201	Communication error between the indoor unit and outdoor unit (Pre-tracking failure or when the actual number of indoor units are different from the indoor unit quantity setting on the outdoor unit) Error due to communication tracking failure after initial power is supplied (The error occurs regardless of the number of units.)	Check indoor quantity setting in outdoor
10	E202	Communication error between indoor unit and outdoor unit (When there is no response from indoor units after tracking is completed)	Check electrical connection and setting between indoor unit and outdoor unit
11	E203	Communication error between the outdoor unit and main micom (For PF #4 to #6 controllers, error will be determined from the time when the compressor is turned on.)	Check electrical connection and setting between indoor unit and outdoor unit
12	E221	Error on outdoor temperature sensor (Short or Open)	Check Outdoor sensor Open / Short
13	E231	Error on outdoor COND OUT sensor (Short or Open)	Check Cond-Out sensor Open / Short
14	E251	Error on discharge temperature sensor of compressor 1 (Short or Open)	Check Discharge sensor Open / Short
15	E320	Error on OLP sensor (Short or Open)	Check OLP sensor Open / Short
16	E403	Compressor down due to freeze protection control	Check Outdoor Cond.
17	E404	System stop due to overload protection control	Check Comp. when it starts
18	E416	System stop due to discharge temperature	-
19	E422	Blockage detected on high pressure pipe	1. Check if the service valve is open 2. Check for refrigerant leakage (pipe connections, heat exchanger) and charge refrigerant if necessary 3. Check if there's any blockage on the refrigerant cycle (indoor unit/outdoor unit) 4. Check if additional refrigerant has been added after pipe extension
20	E425	Reverse phase or open phase	Check whether 3 phase is reversed or opened.
21	E440	Heating operation restricted at outdoor temperature over Theat_high value (default:30°C)	1. Check the range of temperature limited for heating operation 2. Check the outdoor temperature sensor

No.	Error Code	Meaning	Remarks
22	E441	Cooling operation restricted at outdoor temperature below Tcool_low value (default:0°C)	1. Check the range of temperature limited for cooling operation 2. Check the outdoor temperature sensor
23	E458	Fan speed error	FAN1 ERROR
24	E461	Error due to operation failure of inverter compressor	-
25	E462	System stop due to full current control	-
26	E463	Over current trip / PFC over current error	Check OLP sensor
27	E464	IPM Over Current(O.C)	1. Check if the service valve is open 2. Check the state of refrigerant 3. Check if connecting wire and the pipe are OK 4. Check the compressor
28	E465	Comp. Over load error	-
29	E466	DC-Link voltage under/over error	Check AC Power and DC Link Voltage
30	E467	Error due to abnormal rotation of the compressor or unconnected wire of compressor	Check Comp wire
31	E468	Error on current sensor (Short or Open)	Check Outdoor Inverter PBA
32	E469	Error on DC-Link voltage sensor (Short or Open)	-
33	E470	Outdoor unit EEPROM Read/Write error (Option)	Check Outdoor EEPROM Data
34	E471	Outdoor unit EEPROM Read/Write error (H/W)	Check Outdoor EEPROM PBA
35	E474	Error on IPM Heat Sink sensor of inverter 1 (Short or Open)	Check Outdoor Inverter PBA
36	E475	Error on inverter fan 2	FAN2 ERROR
37	E483	Overvoltage of H/W detect DC link	Check AC Power
38	E484	PFC Overload (Over current) Error	Check Outdoor Inverter PBA
39	E485	Error on input current sensor of inverter 1 (Short or Open)	Check Outdoor EEPROM PBA
40	E488	Inverter input voltage sensor error	Check Outdoor Inverter PBA
41	E500	IPM over heat error on inverter 1	Check Outdoor Inverter PBA
42	E508	Smart install is not installed	-
43	E554	Gas leak detected	Check the refrigerant
44	E556	Error due to mismatching capacity of indoor and outdoor unit	Check the indoor and outdoor unit capacity
45	E557	DPM remote controller option error	Check the indoor option code
46	E590	Inverter EEPROM Checksum error	-

## 4-3 Troubleshooting by symptoms

### 4-3-1 Indoor temperature sensor (open/short)

<b>Indoor unit display</b>	X (Operation) ● (Defrost) X (Timer) X (Filter)
<b>Symptom</b>	In case of open or short circuit of indoor temperature sensor
<b>Failure</b>	Short or leakage of the corresponding sensor

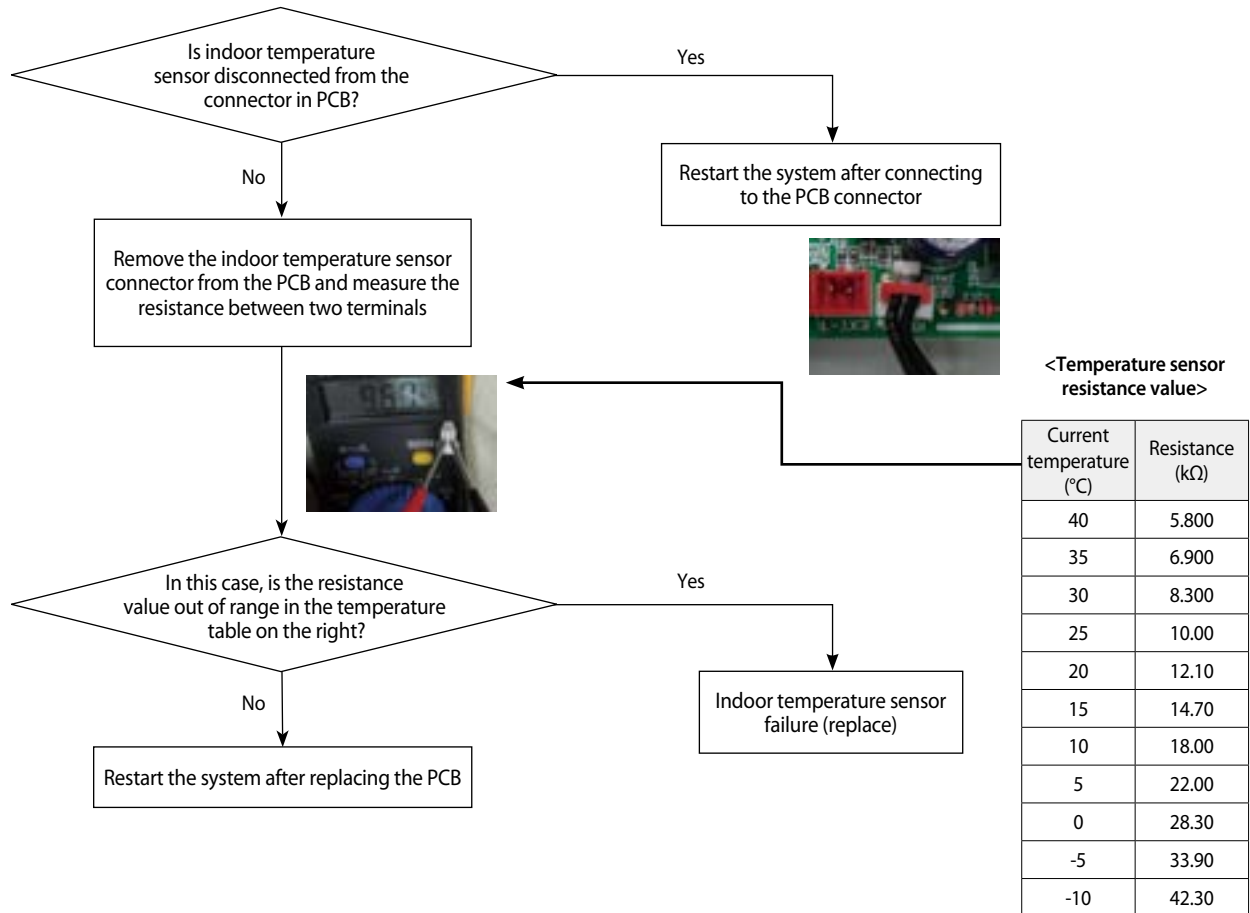

### 4-3-2 Indoor heat exchanger temperature sensor (open/short)

<b>Indoor unit display</b>	● (Operation) ● (Defrost) X (Timer) X (Filter)
<b>Symptom</b>	Short or open circuit of indoor heat exchanger temperature sensor
<b>Failure</b>	Short or open circuit in the corresponding sensor

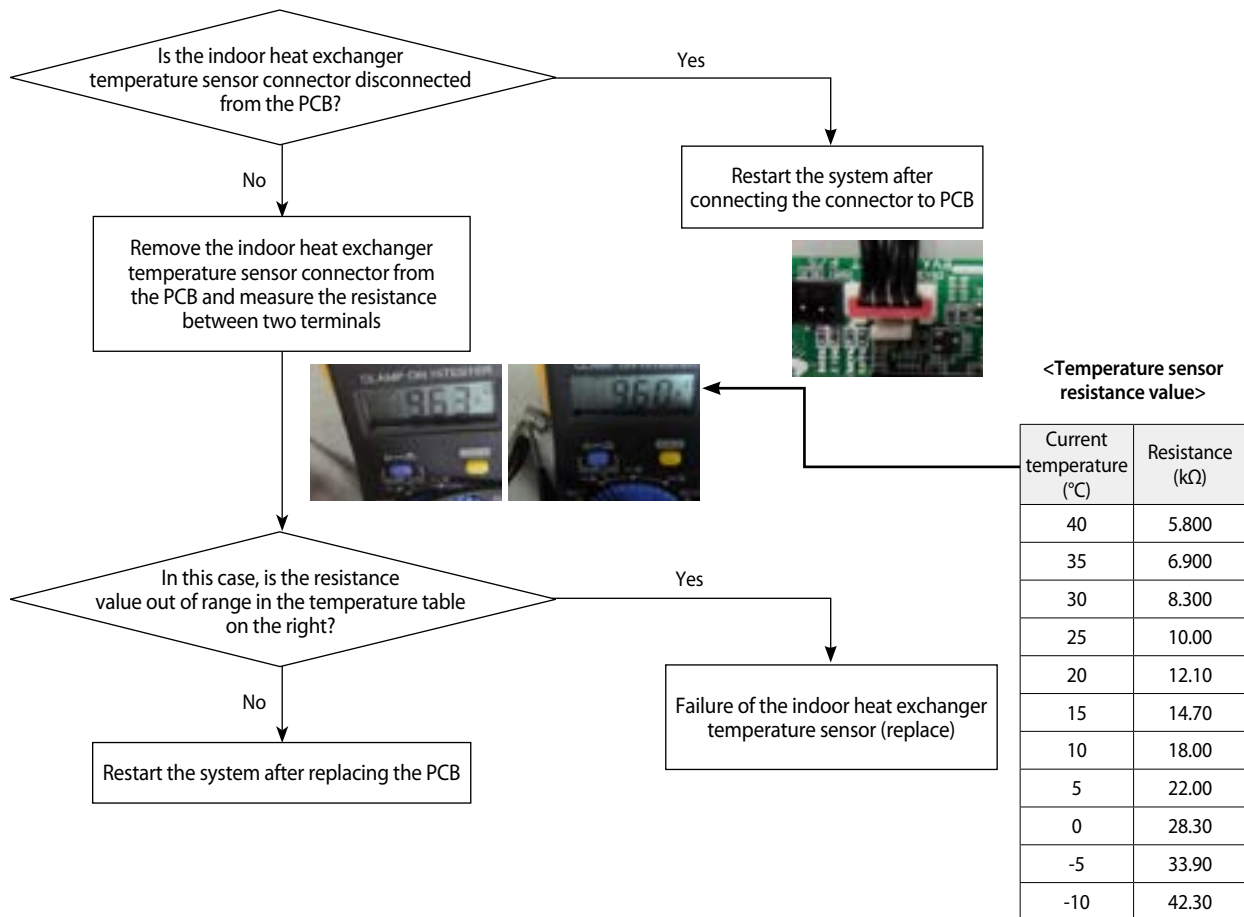

### 4-3-3 Indoor FAN error

<b>Indoor unit display</b>	X (Operation) X (Defrost) ● (Timer) X (Filter)
<b>Symptom</b>	Indoor unit fan does not run /Runs at excessive high speed and stops.
<b>Failure</b>	. Motor connector break away . Indoor unit FAN does not run : Defective motor or PBA

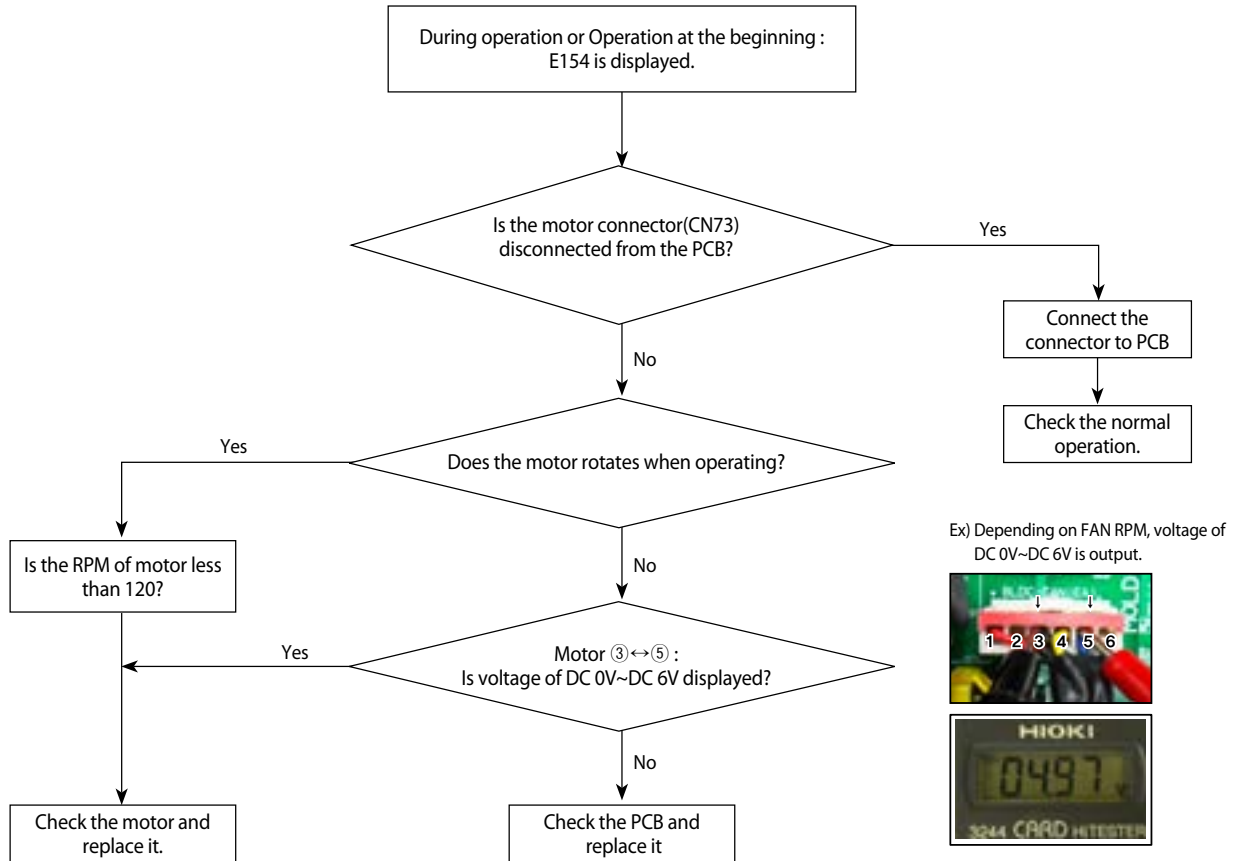

### 4-3-4 Communication error after finishing Tracking

<b>Indoor unit display</b>	X (Operation) ● (Defrost) ● (Timer) X (Filter)
<b>Symptom</b>	Communication error between the indoor and outdoor unit for two minutes
<b>Failure</b>	Communication error between the indoor unit and outdoor unit

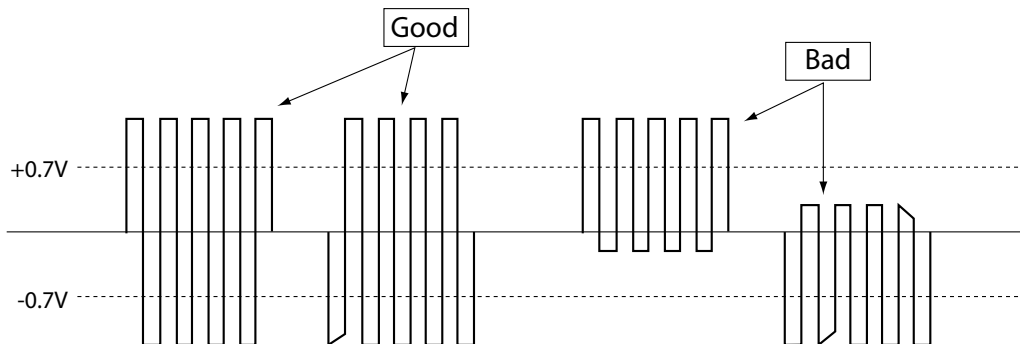
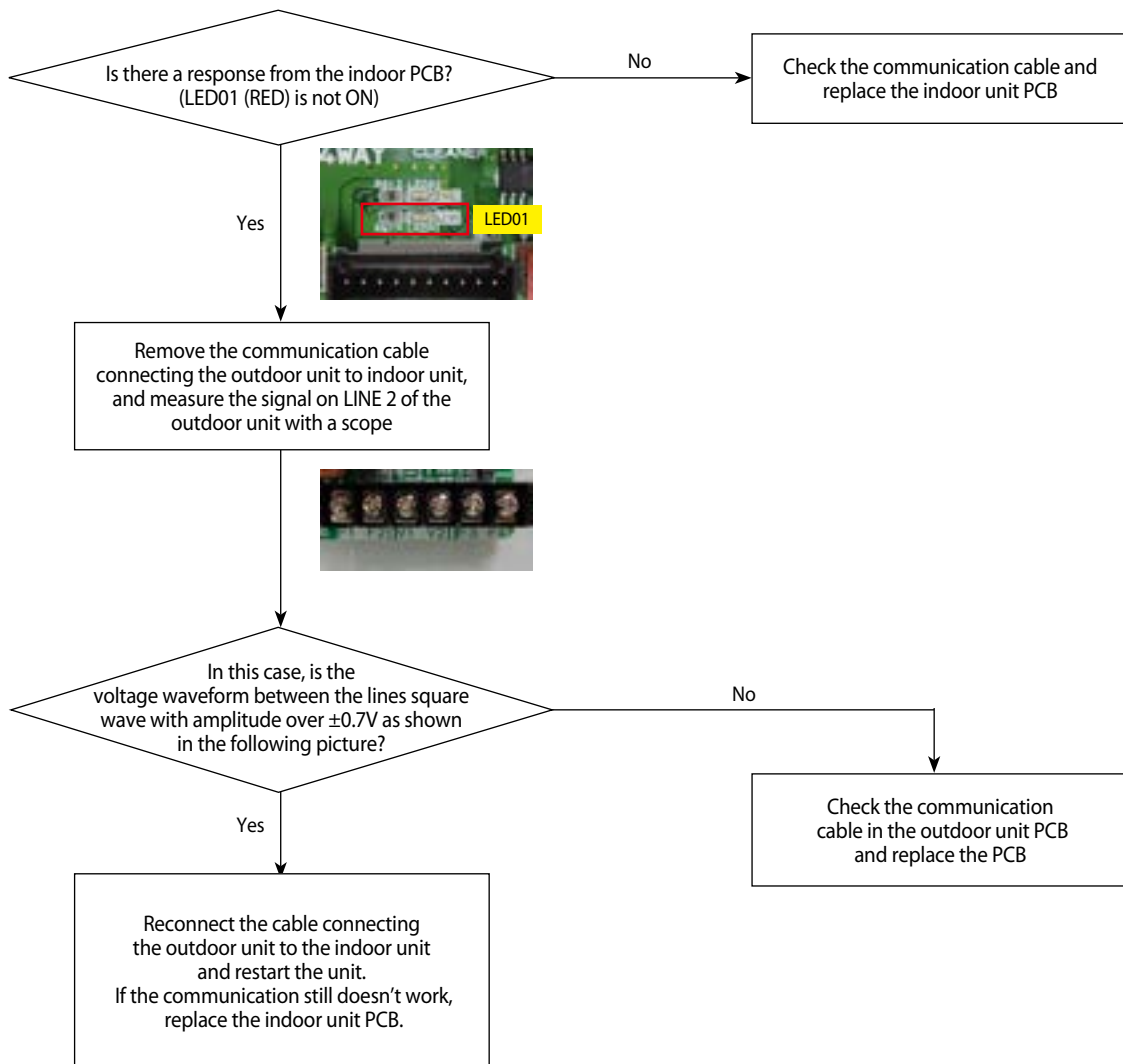



### 4-3-5 Indoor unit float sensor error

<b>Indoor unit display</b>	X (Operation) X (Defrost) ● (Timer) ● (Filter)
<b>Symptom</b>	The indoor unit floating sensor is open and that state is maintained for more than one minute
<b>Failure</b>	Increase in the drain pan water level due to failure of the indoor unit drain pump, or float sensor failure

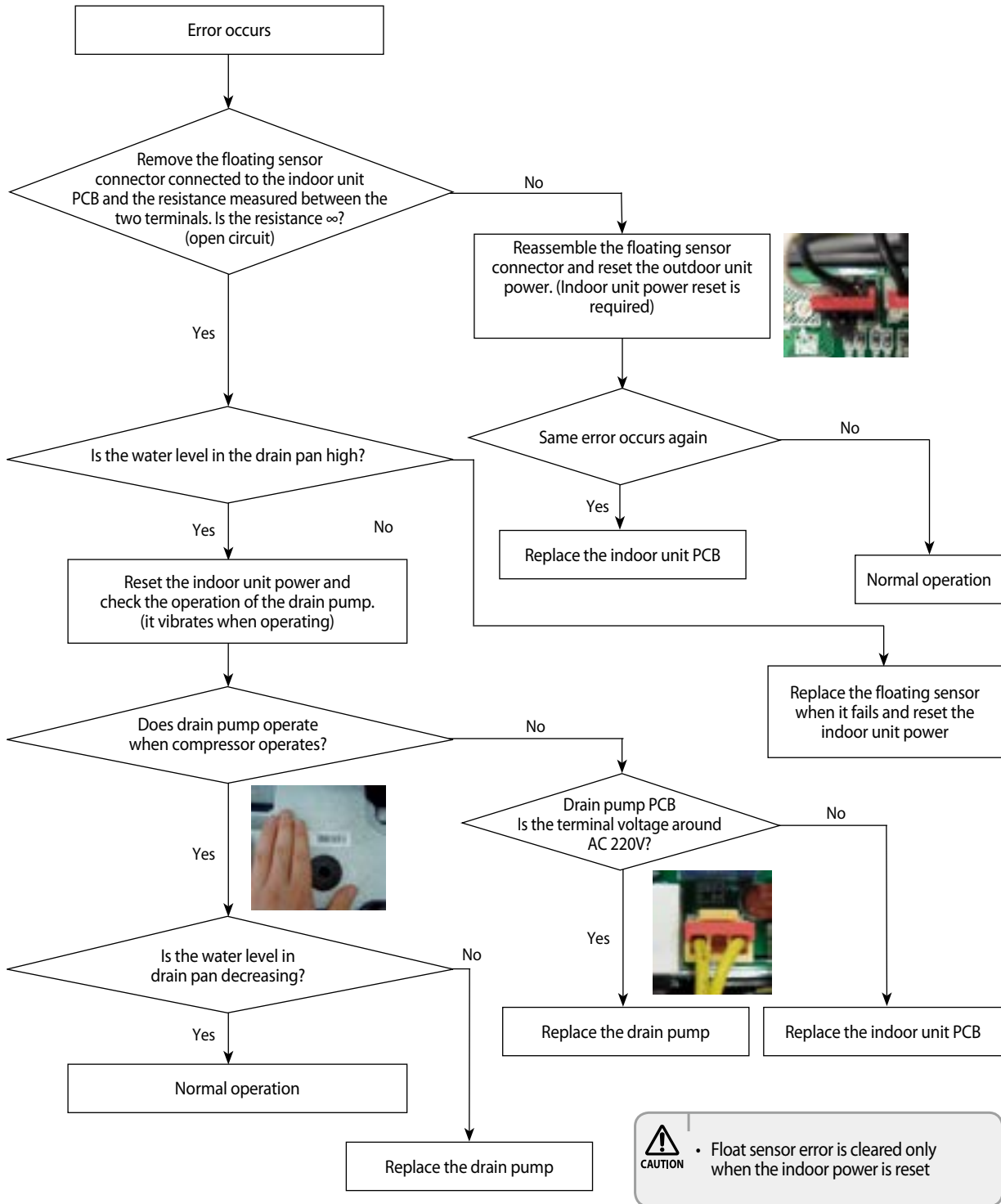

### 4-3-6 EEPROM circuit failure

Indoor unit display	● (Operation) ● (Defrost) ● (Timer) X (Filter)
Symptom	EEPROM circuit failure
Failure	EEPROM component failure, EEPROM circuit parts missing/damaged/soldering failure

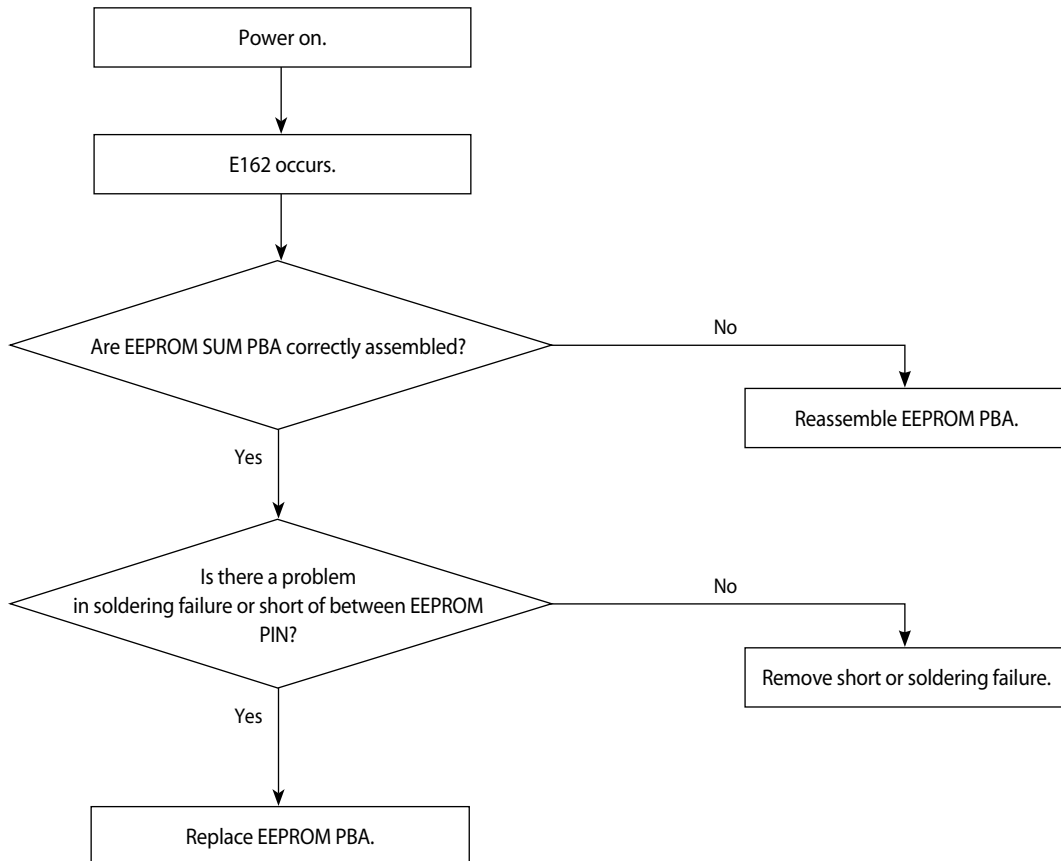

### 4-3-7 Thermal Fuse Open Error

<b>Indoor unit display</b>	X (Operation) ● (Defrost) ● (Timer) ● (Filter)
<b>Symptom</b>	Thermal Fuse Open Error
<b>Failure</b>	Check the connection of the CN140 wire. Check the connection of the terminal block. (Temperature rise by untightening a screw/ Termal Fuse open)

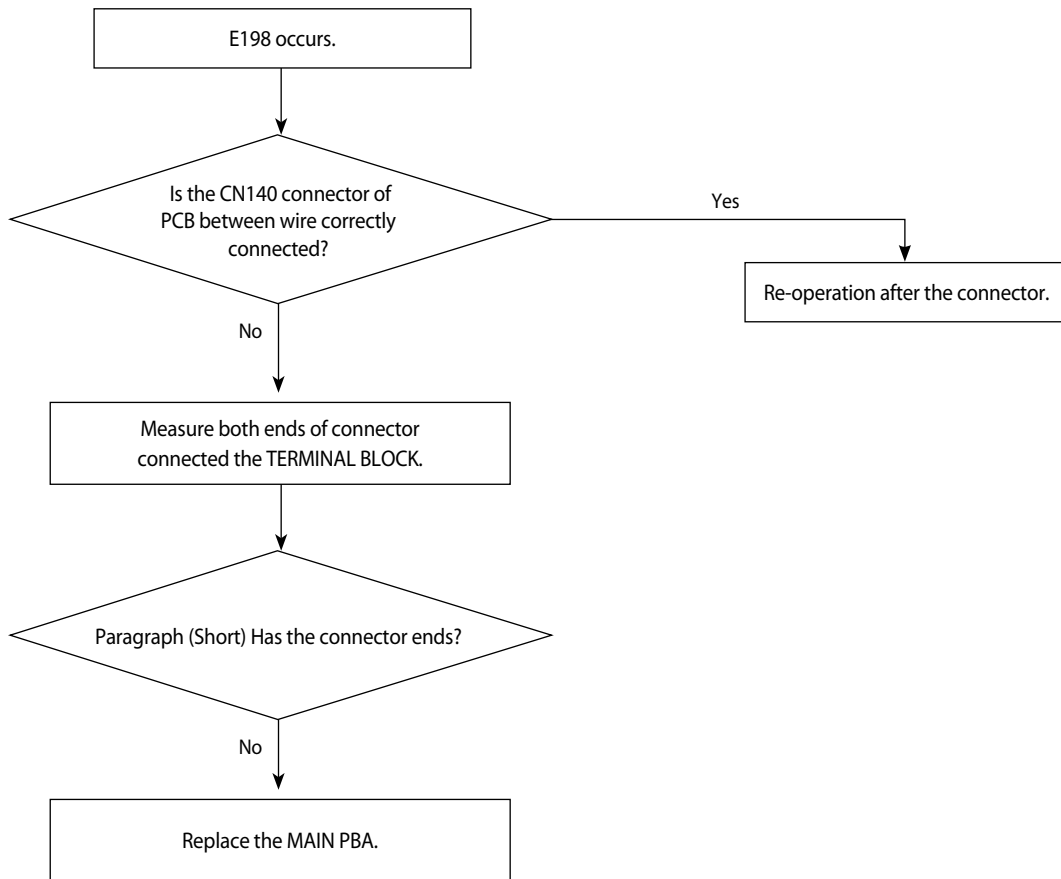

### 4-3-8 When the outdoor unit power is not ON - Initial Diagnosis : 3-phase products

1. Test items

- 1) Check the power connection of outdoor unit.
  - 2) Check the whole connection part of the power wire.
  - 3) Check the power on the indoor unit.
  - 4) Check the connection of the power wire of the Terminal Block.
  - 5) Check the connection of the power wire between the Main↔EMI PBA of the outdoor unit.
  - 6) Connect the power wire. (Never forget to turn off the power of the Terminal Box).
  - 7) Check the power supply parts. (Check after turning off the power of the Terminal Box!)
  - 8) Check everything is normal after separating the fan motor connector and resetting the power.
- (Separate the connector after turning off the power of the Terminal Box! When detaching and attaching the connector during power supply, the motor can be damaged.)
- 7-segment off.
  - Conduct the following test if the mode is not Eco-mode (power saving mode).

2. Check procedure

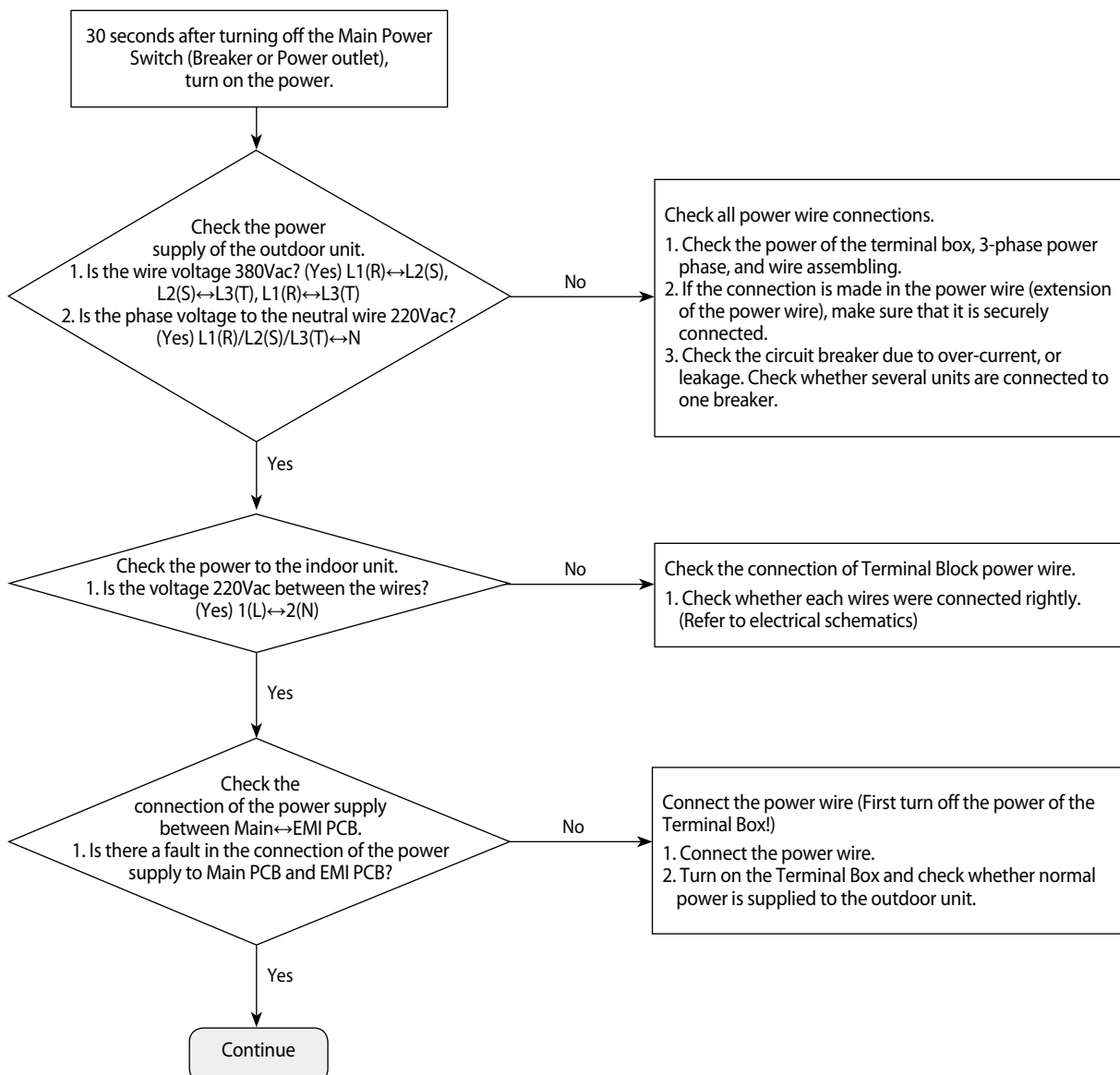

### When the outdoor unit power is not ON - Initial Diagnosis : 3-phase products (cont.)

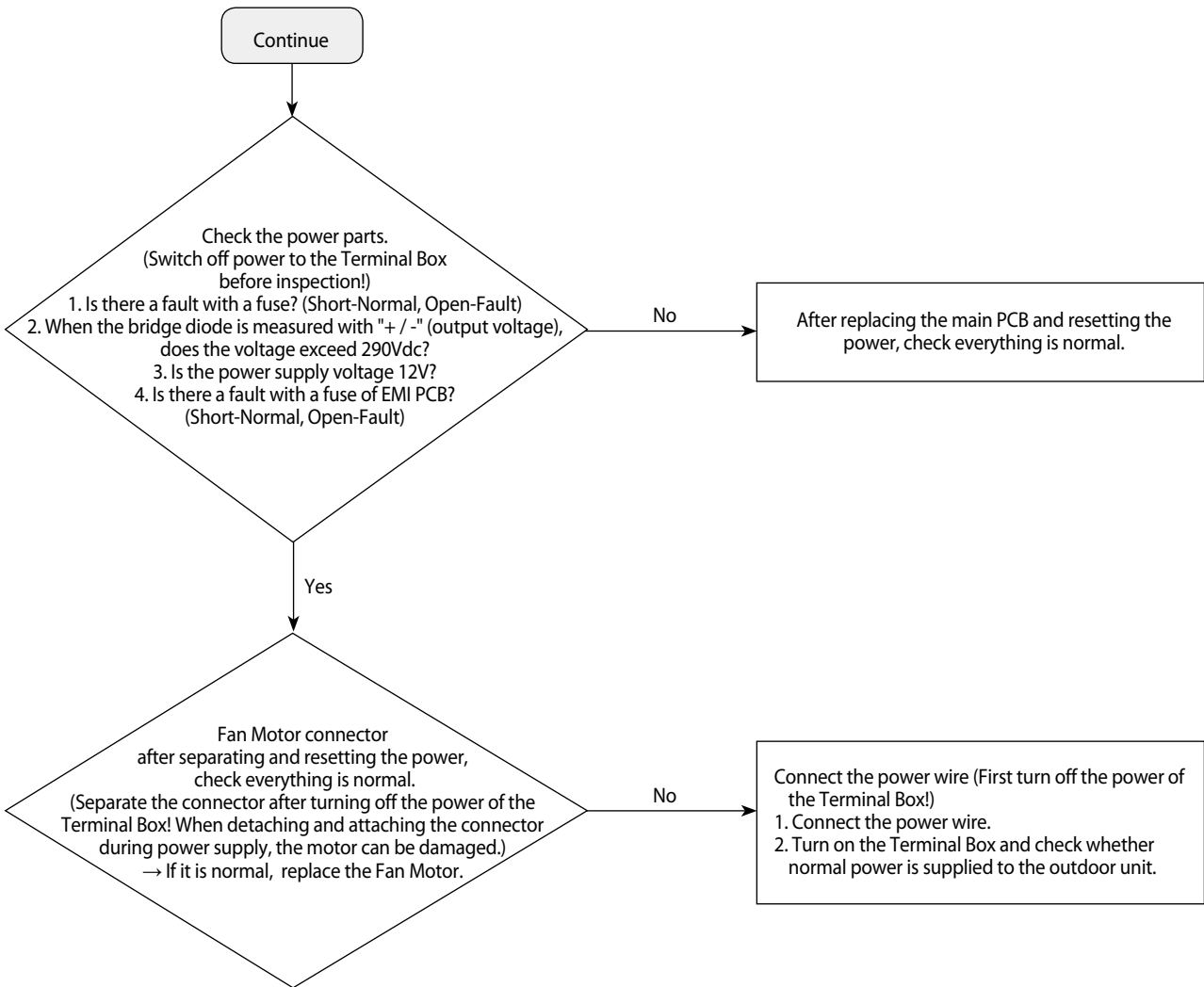

## When the outdoor unit power is not ON - Initial Diagnosis : 1-phase products

### 1. Test items

- 1) Check the power connection of outdoor unit.
- 2) Check the whole connection part of the power wire.
- 3) Check the power on the indoor unit.
- 4) Check the connection of the power wire of the Terminal Block.
- 5) Check the connection of the power wire between the Main↔EMI PBA of the outdoor unit.
- 6) Connect the power wire. (Never forget to turn off the power of the Terminal Box).
- 7) Check the power supply parts. (Check after turning off the power of the Terminal Box!)
- 8) Check everything is normal after separating the fan motor connector and resetting the power.

- 7-segment off.
- Conduct the following test if the mode is not Eco-mode (power saving mode).

(Separate the connector after turning off the power of the Terminal Box! When detaching and attaching the connector during power supply, the motor can be damaged.)

### 2. Check procedure

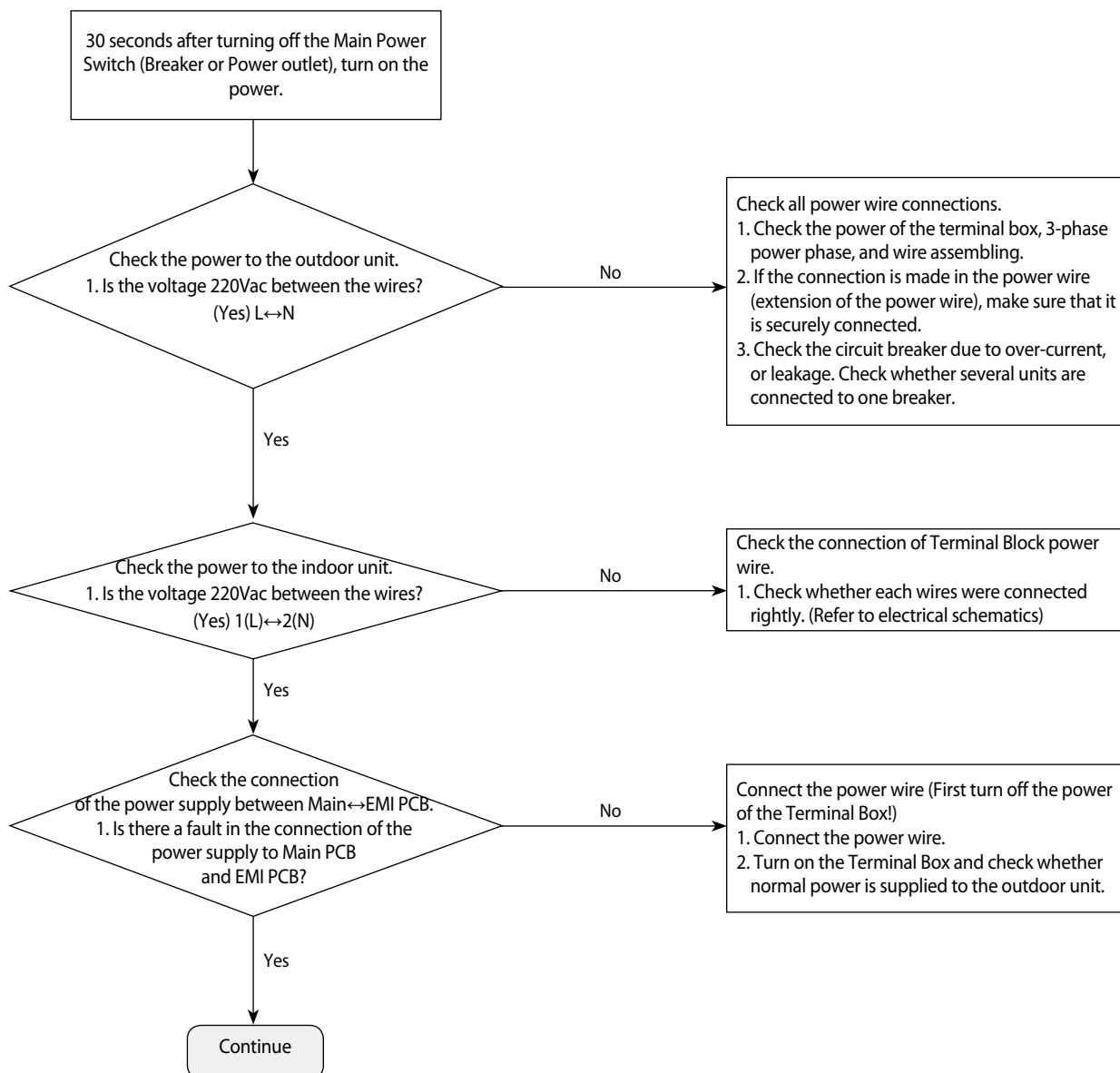

**When the outdoor unit power is not ON - Initial Diagnosis : 1-phase products (cont.)**

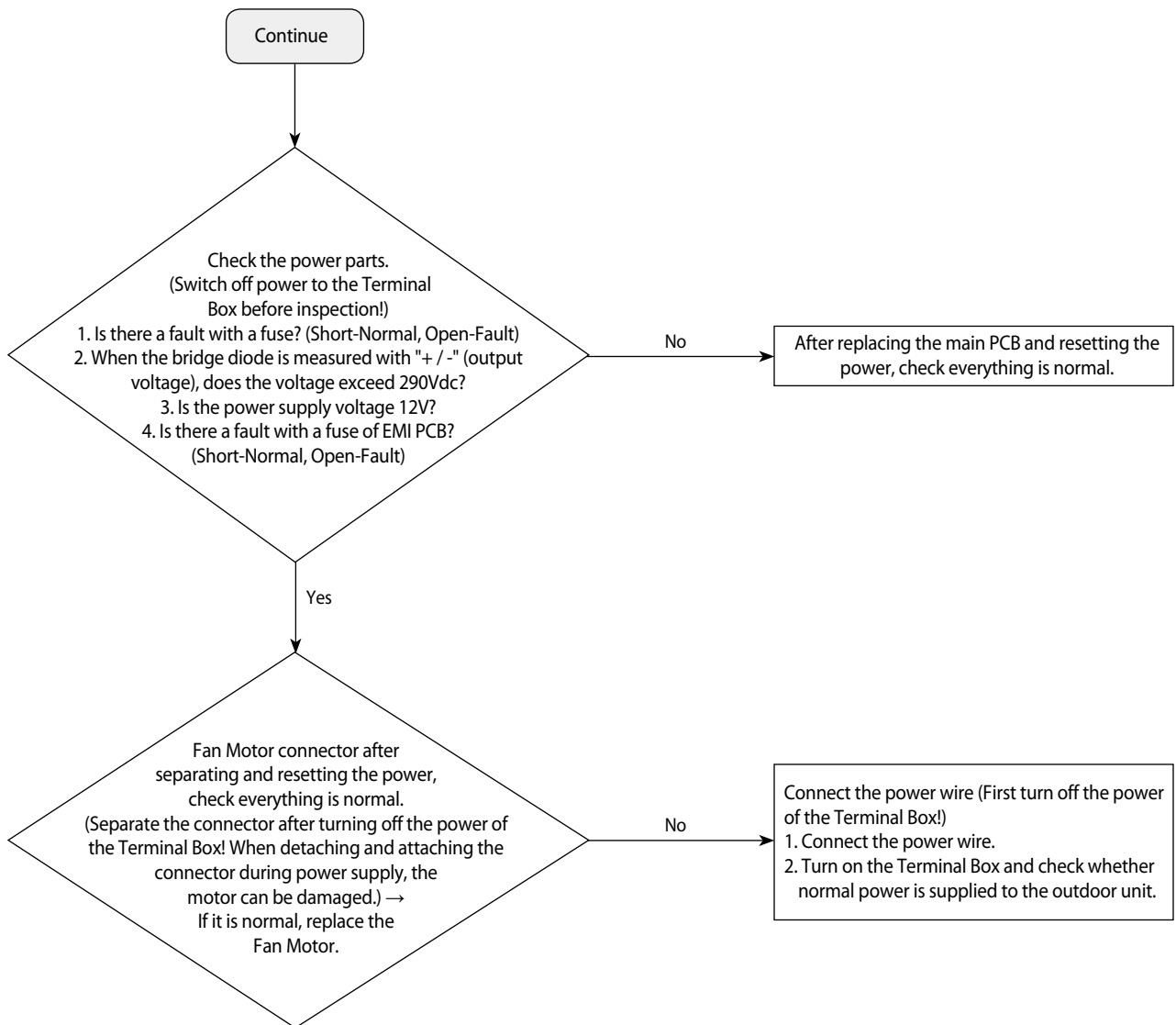

### 4-3-9 Indoor/outdoor communication error (1 min.) (Error Code : E202)

1. Test items

- 1) Check the communication wire and power wire connection.
- 2) Check the communication connector connection.
  - CN31 of outdoor unit Main PCB .
- 3) Check the communication circuit on the PCB.

2. Check procedure

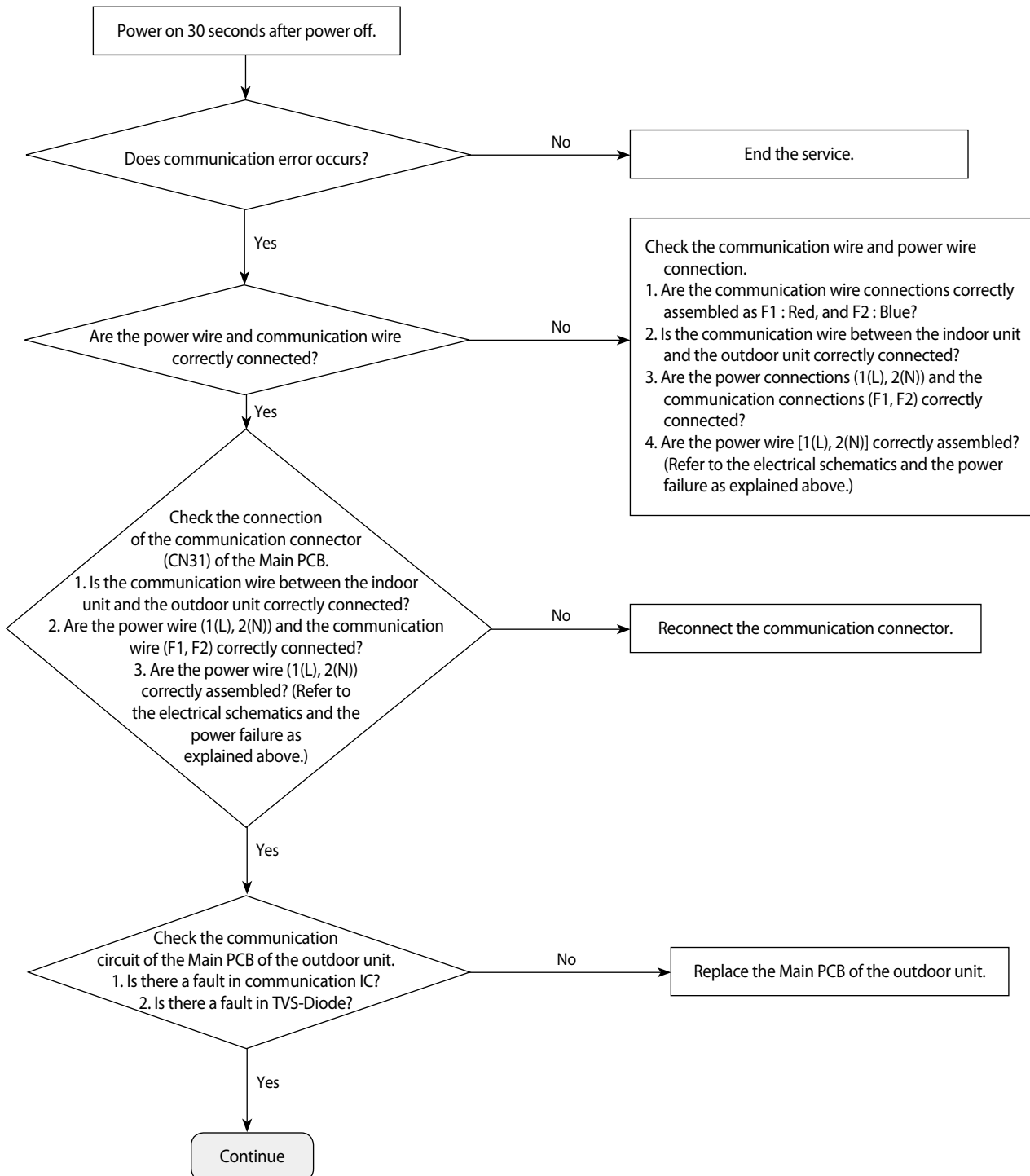



**Indoor/outdoor communication error (1 min.) (Error Code: E202) (cont.)**

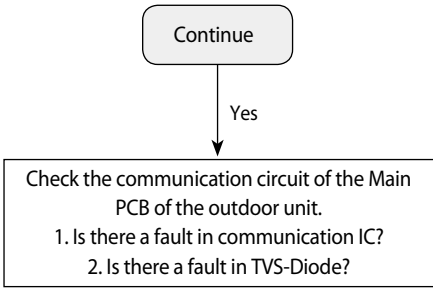

Measuring Part	Communication IC Measuring Part (Circuit Diagram)	Example of Measuring Communication IC	Example of Measuring TVS-Diode
Location			
Measuring Point	#5-GND, #6- Communication A, #7- Communication B, #8-Vcc		

Communication IC Measuring (Port)	Steady-state Measuring Value		Remark
	COM 1 (RED)		
#6 - #5	0.9kΩ ~ 1.2kΩ		Measuring after separating the communication connection
#7 - #5	0.9kΩ ~ 1.2kΩ		
#8 - #5	4.7Vdc ~ 5.3Vdc		

TVS-Diode Measuring	Steady-state Measuring Value
Both ends of diode	1kΩ or above

### 4-3-10 Communication error between outdoor unit INV ↔ MAIN MICOM (1 min.)(Error Code: E203)

1. Test items

- 1) Is power supplied to outdoor unit Inverter PCB?
- 2) Check the power wire connection and fuse.
- 3) Is there a problem in the communication wire connections between the outdoor unit Inverter (CN31) ↔ Main PCB (CN39)?
- 4) Check the communication wire connections.

2. Check procedure

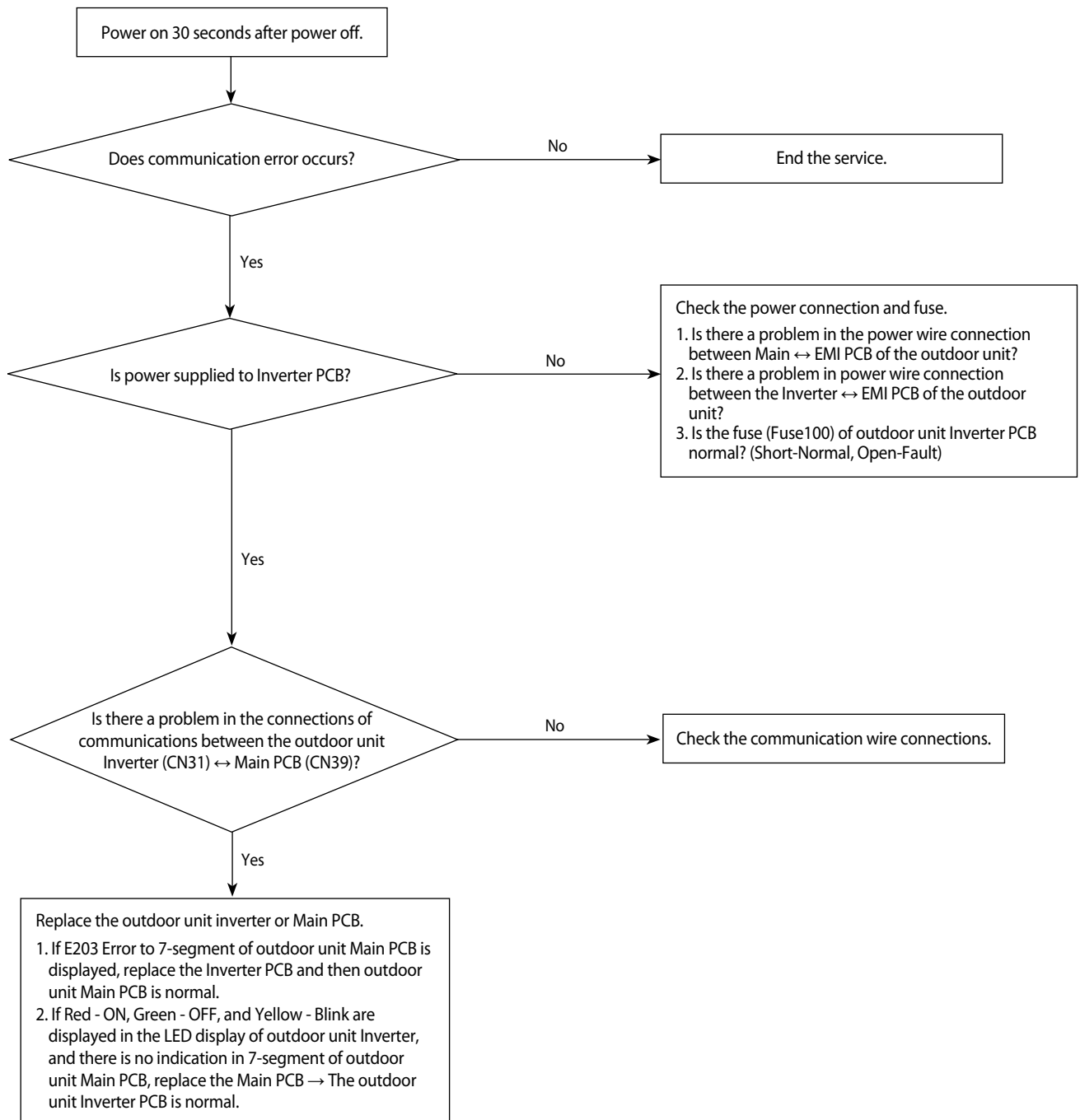

### 4-3-11 Outdoor sensor error(Error Code : E221, E231, E251, E320)

1. Test items
  - 1) Check the connection of the temperature sensor connector.
  - 2) Check the resistance value of the temperature sensor.

Error CODE	Description
E221	Outdoor temperature sensor error
E231	Outdoor temperature sensor error
E251	Outdoor temperature sensor error
E320	Outdoor OLP sensor error

2. Check procedure

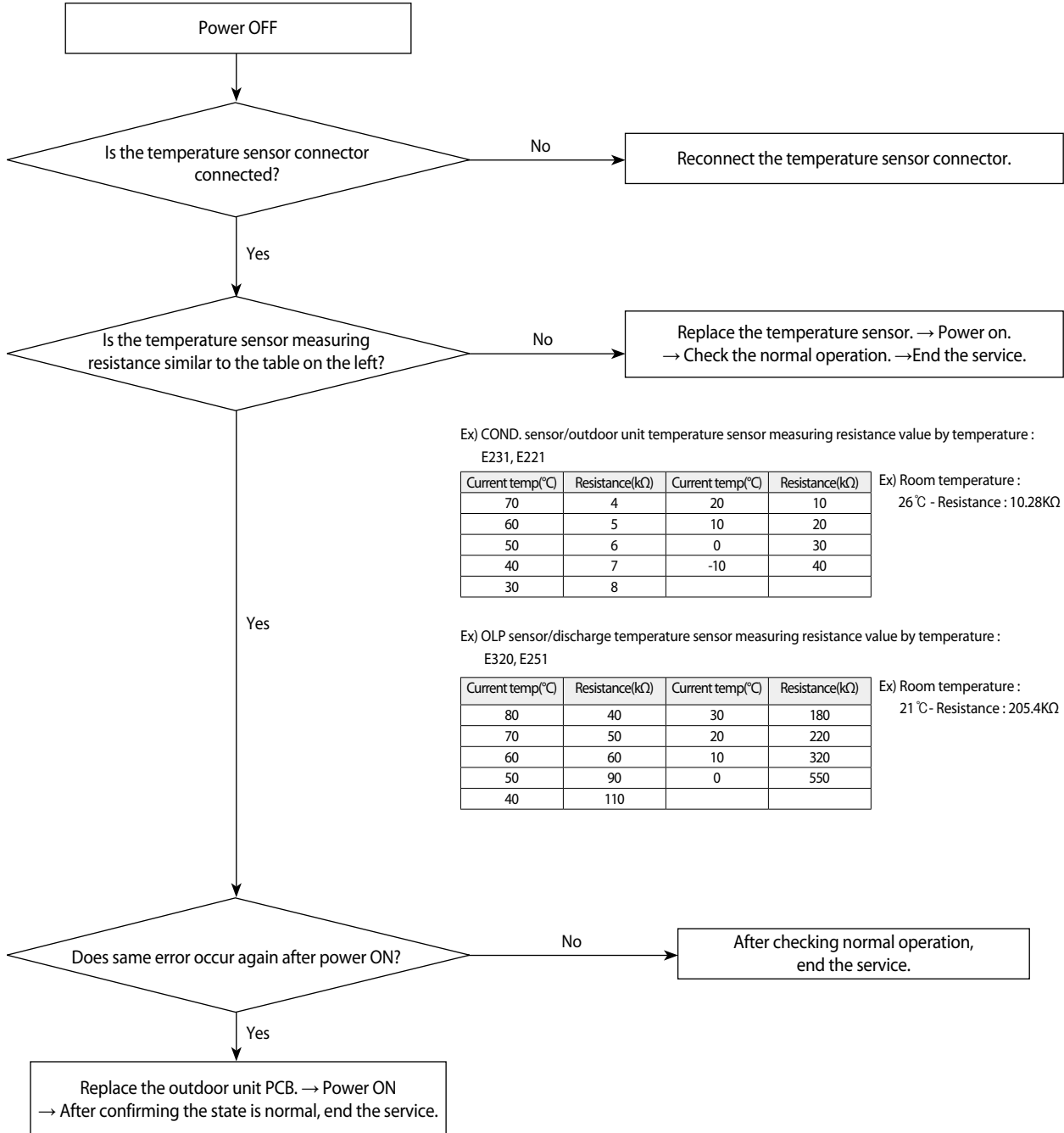

Ex) COND. sensor/outdoor unit temperature sensor measuring resistance value by temperature :  
E231, E221

Current temp(°C)	Resistance(kΩ)	Current temp(°C)	Resistance(kΩ)
70	4	20	10
60	5	10	20
50	6	0	30
40	7	-10	40
30	8		

Ex) Room temperature :  
26 °C - Resistance : 10.28KΩ

Ex) OLP sensor/discharge temperature sensor measuring resistance value by temperature :  
E320, E251

Current temp(°C)	Resistance(kΩ)	Current temp(°C)	Resistance(kΩ)
80	40	30	180
70	50	20	220
60	60	10	320
50	90	0	550
40	110		

Ex) Room temperature :  
21 °C - Resistance : 205.4KΩ

#### 4-3-12 Reverse phase / Loss phase detection (3-phase outdoor unit) (Error Code : E425 )

1. When power is on, it checks the power status used for 3-phase power compressor.  
When the order of 3-phase L1(R) – L2(S) – L3(T) is changed (Reverse phase) or there is a phase that does not supply power (Loss phase), it will display **E425** and the air conditioner will stop operating. **E425**

- 1) Check the voltage on L1(R) – L2(S) phase/ L1(R) – L3(T) phase/ L2(S) – L3(T) phase.
- 2) When there is any terminal that does not have normal voltage, check the external power of the air conditioner and take appropriate measures.
- 3) If 3-phase power is normal check the phase of the power wire using 3-phase tester. If it shows reverse phase, change the current power wire connection.
- 4) After completing above, press reset key (K3) then check the power again.

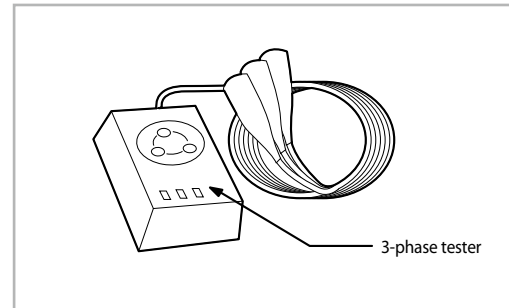

### 4-3-13 Compressor down due to freezing control (Error Code : E403)

1. Test items

- 1) Check the normal operation of indoor Fan/Motor.
- 2) Check the normal operation of indoor EEV.
- 3) Check the IN/OUT sensor of indoor heat exchanger.
- 3) Check the clogging of indoor air inlet part.

2. Check procedure

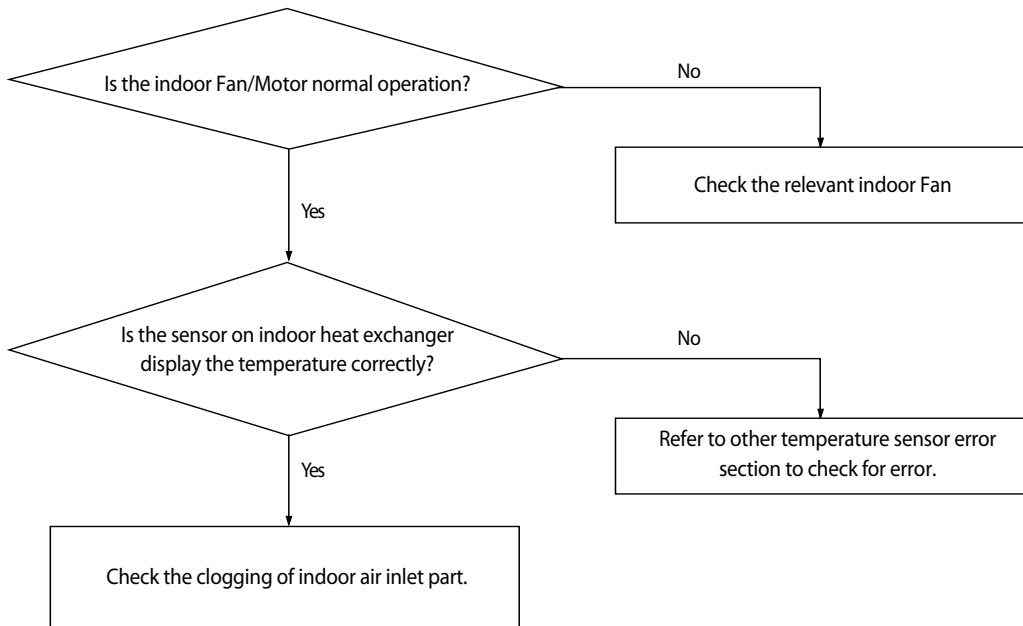

### 4-3-14 Outdoor unit Fan error (Error Code : E458, E475)

1. Test items

- 1) Check the connection of Fan connectors (CN90, CN91)
- 2) Check the voltage of the fan motor connector in the inverter PBA of the outdoor unit.
- 3) Check the power connection of the outdoor unit Inverter PCB.
- 4) Check the Fan Motor single parts. (Be sure to turn off the power and separate the motor connector after 30 seconds!)

2. Check procedure

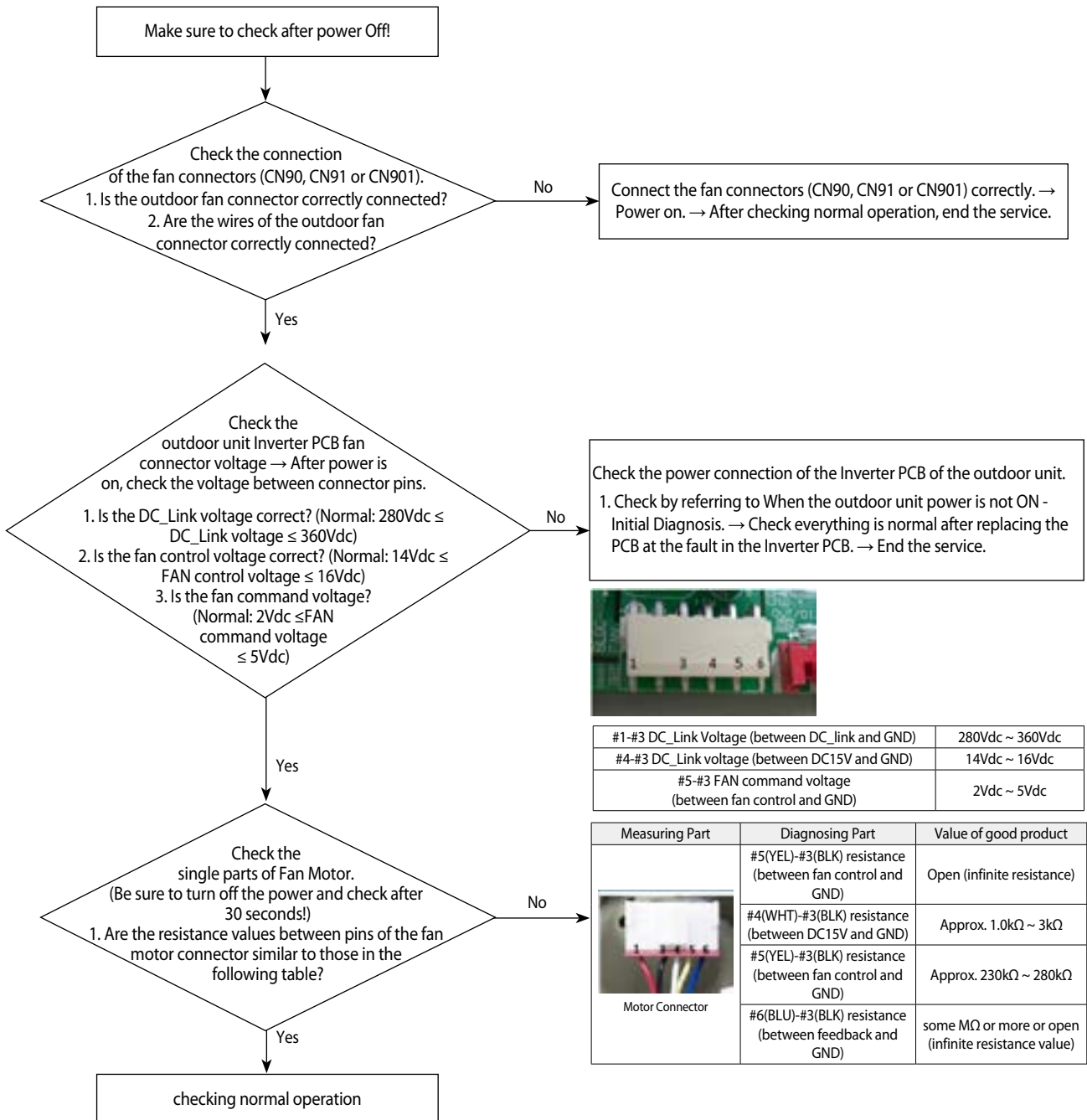

- ※ At least 30 seconds after power is OFF, attach/detach the fan motor connector! → Threatened to cause secondary damage to the motor and the PCB.
- ※ Check the Inverter PCB or Fan Motor single parts and only if there is a fault, replace!
- ※ Do not replace the Main PCB of the outdoor unit relating to the fault in the Fan Motor!  
 → If the error is indicated on 7-segment of the Main PCB of the outdoor unit, the Main PCB of the outdoor unit has no fault.  
 → In case of a control problem, it is possible to solve with S/W update.

### 4-3-15 Compressor starting error / rotation error (Error Code : E461, E467)

1. Test items
  - 1) Check the power connection. / Check the restart after power reset.
  - 2) Check the compressor and the state of the compressor wire assembling.
  - 3) Check the defective for compressor wire single parts.

2. Check procedure

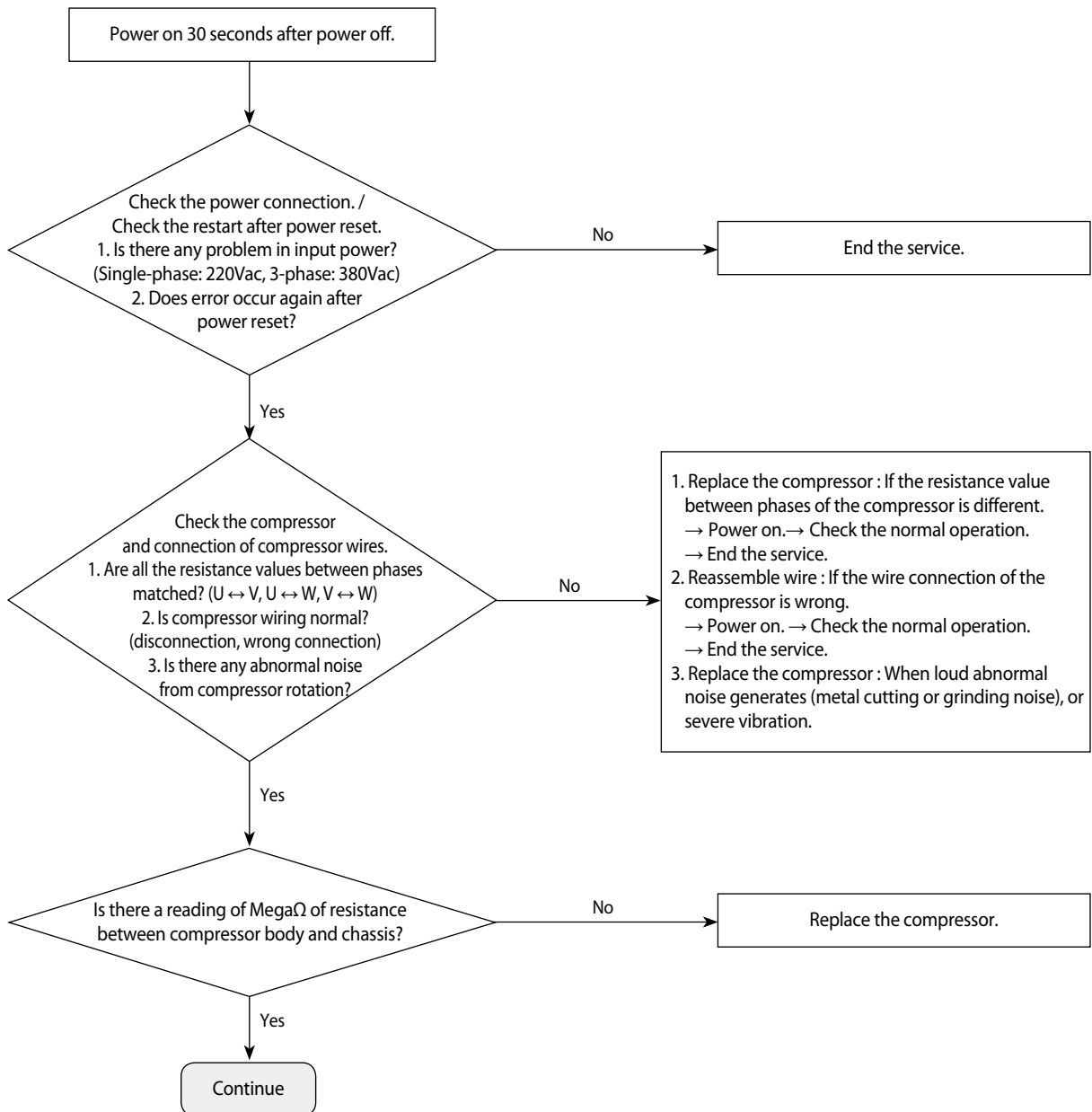

**Compressor starting error / rotation error (Error Code : E461, E467) (cont.)**

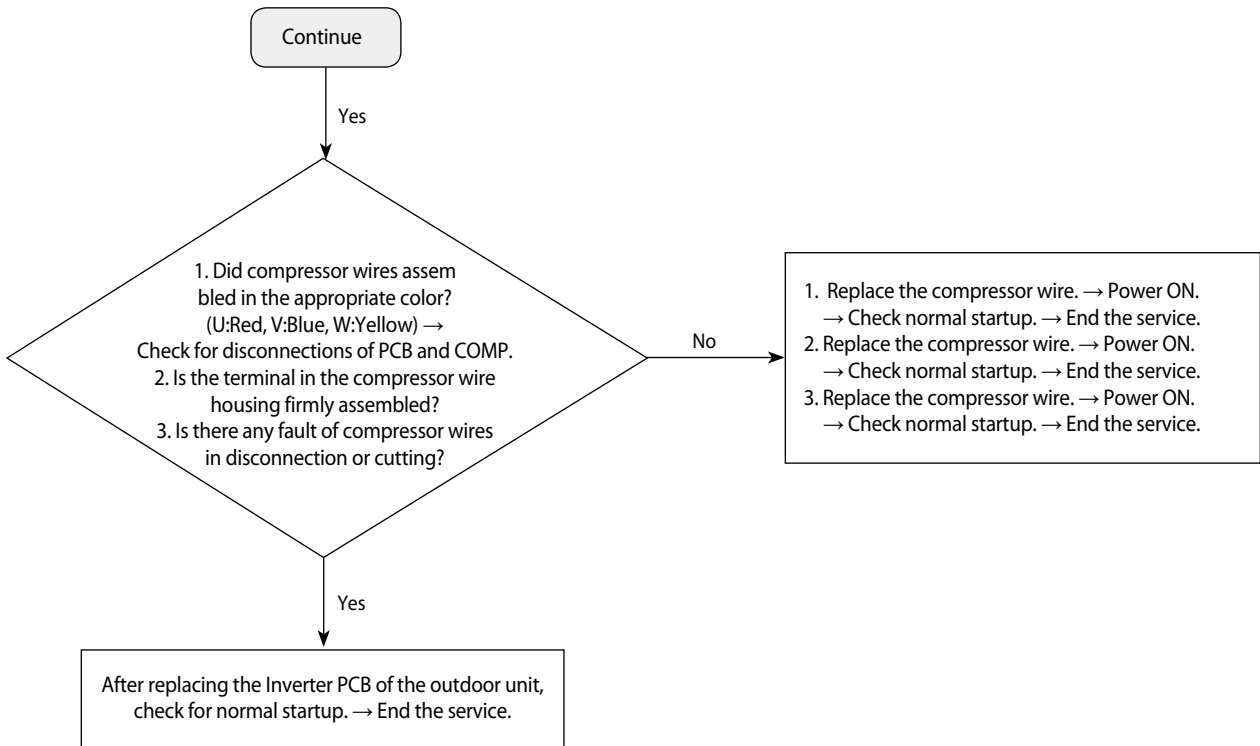

- ※ E461, E467 Error-related, EMI / outdoor unit Main / Indoor unit Main PCB do not replace!  
→ This error is related to the compressor and Inverter PCB. (Not related to the above PCB)
- ※ Ensure that the service valve is open!  
→ When the service valve is closed, the defects may be caused by differential pressure when starting the compressor.



### 4-3-16 Full current error / PFC over-current error (Error Code : E462, E484)

1. Test items

- 1) Check the power connection. / Check the restart after power reset.
- 2) Install outdoor unit and check environment.  
→ Check for wire disconnection related to outdoor unit Inverter PCB and check the installation environment.
- 3) Check the indoor unit installation environment.
- 4) Check the opening of service valve.

2. Check procedure

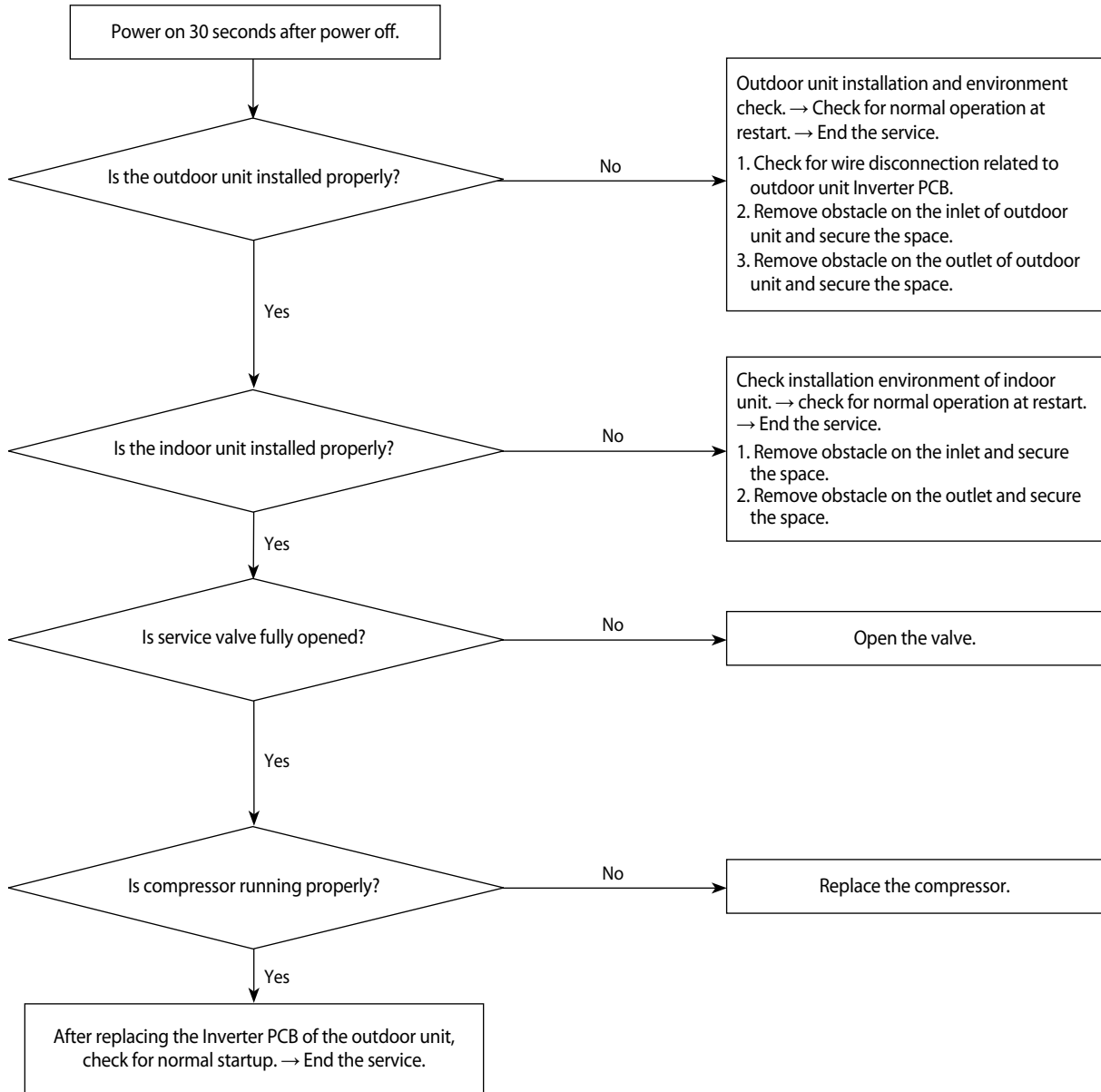

### 4-3-17 IPM IPM (Over Current) error (Error Code : E464)

1. Test items

- 1) Check the power connection. / Check the restart after power reset.
- 2) Install outdoor unit and check environment.  
 → Check for wire disconnection related to outdoor unit Inverter PCB and check the installation environment.  
 → After having installed several units, please check that communication wires are not interchanged with piping.
- 3) Check the indoor unit installation environment.
- 4) Check the opening of service valve.
- 5) Check the status of compressor assembly and wiring.
- 6) Check the defective for compressor wire single parts.

2. Check procedure

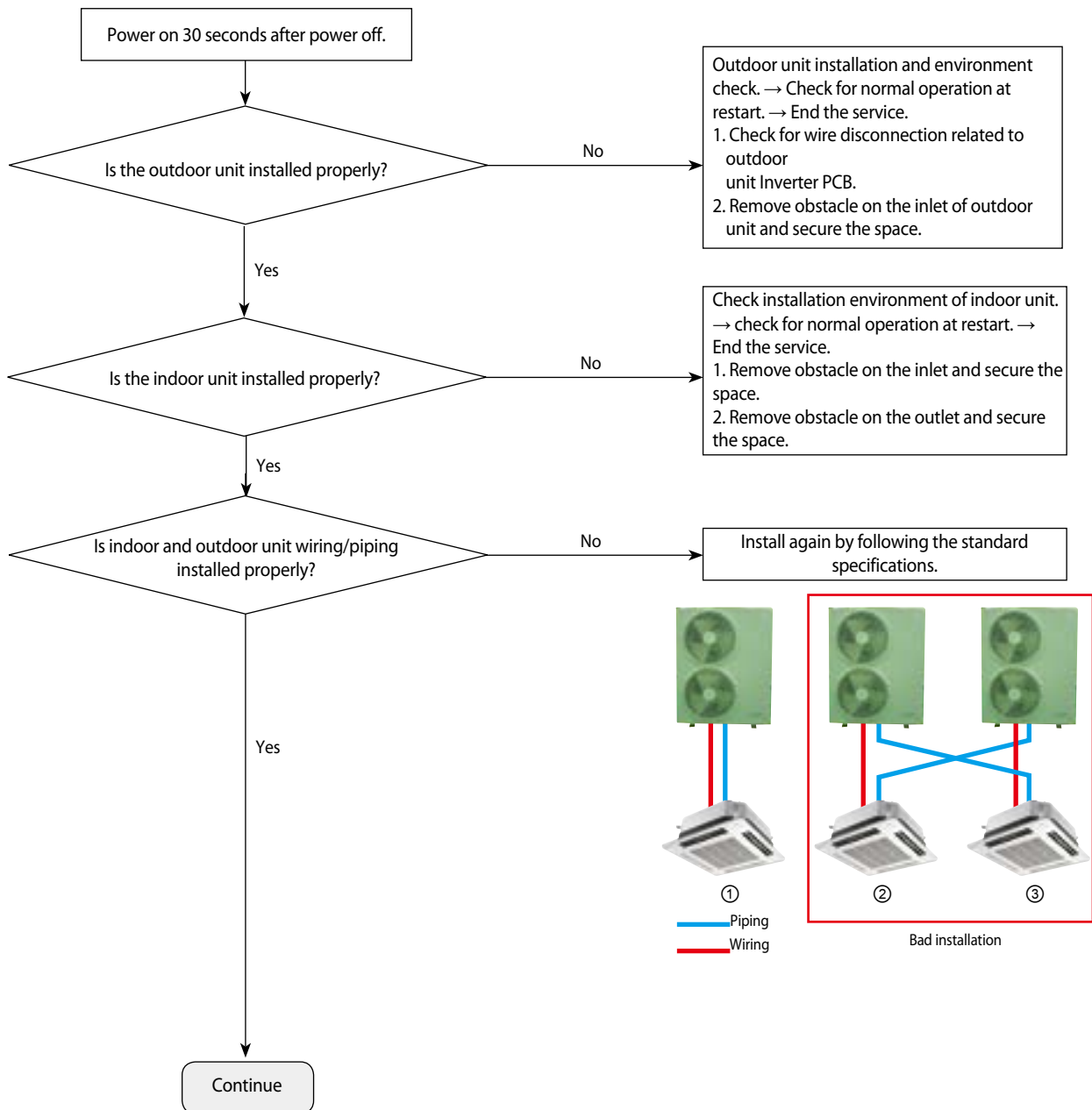

**IPM over(Over Current) error (Error Code : E464)(cont.)**

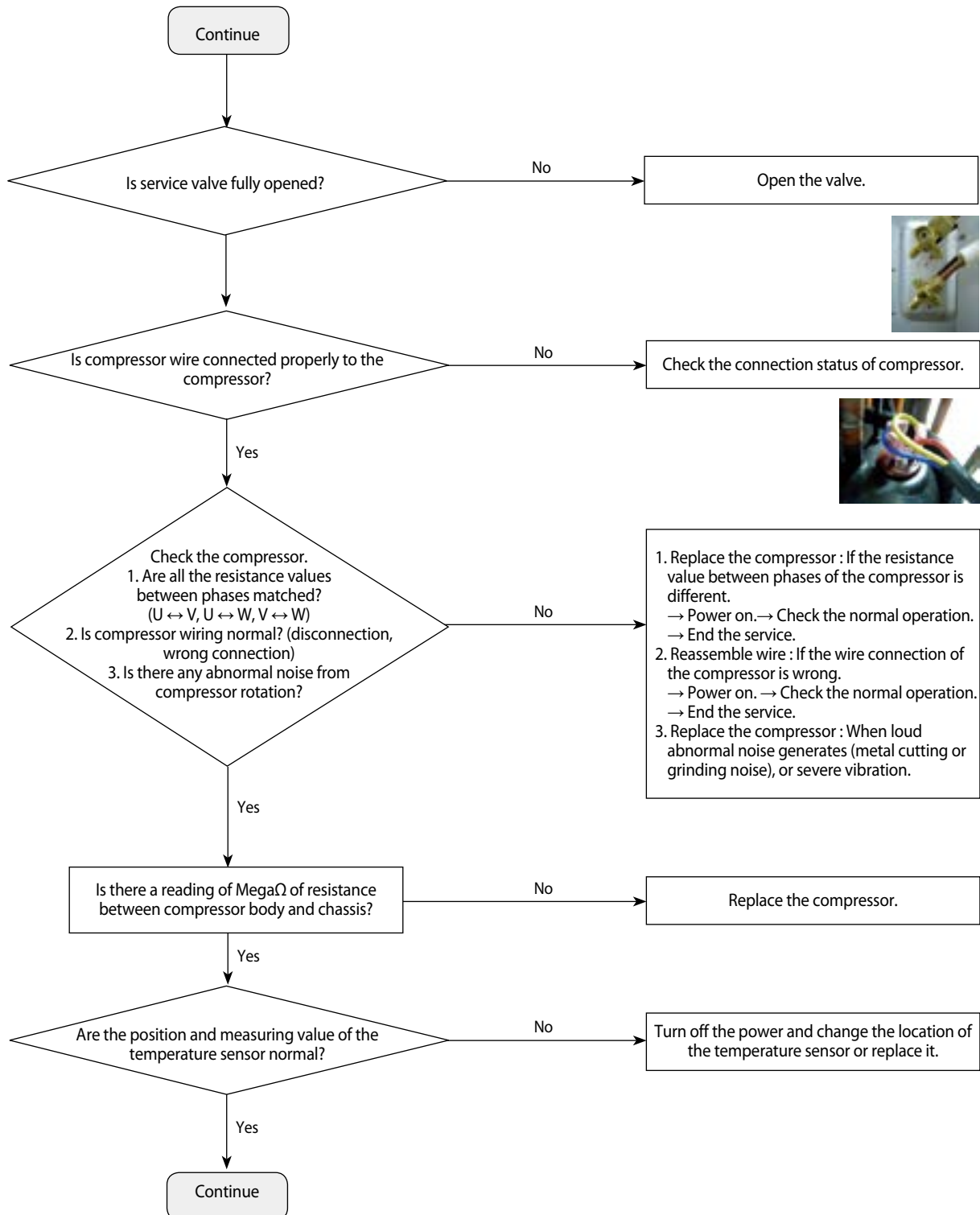

### IPM over(Over Current) error (Error Code : E464)(cont.)

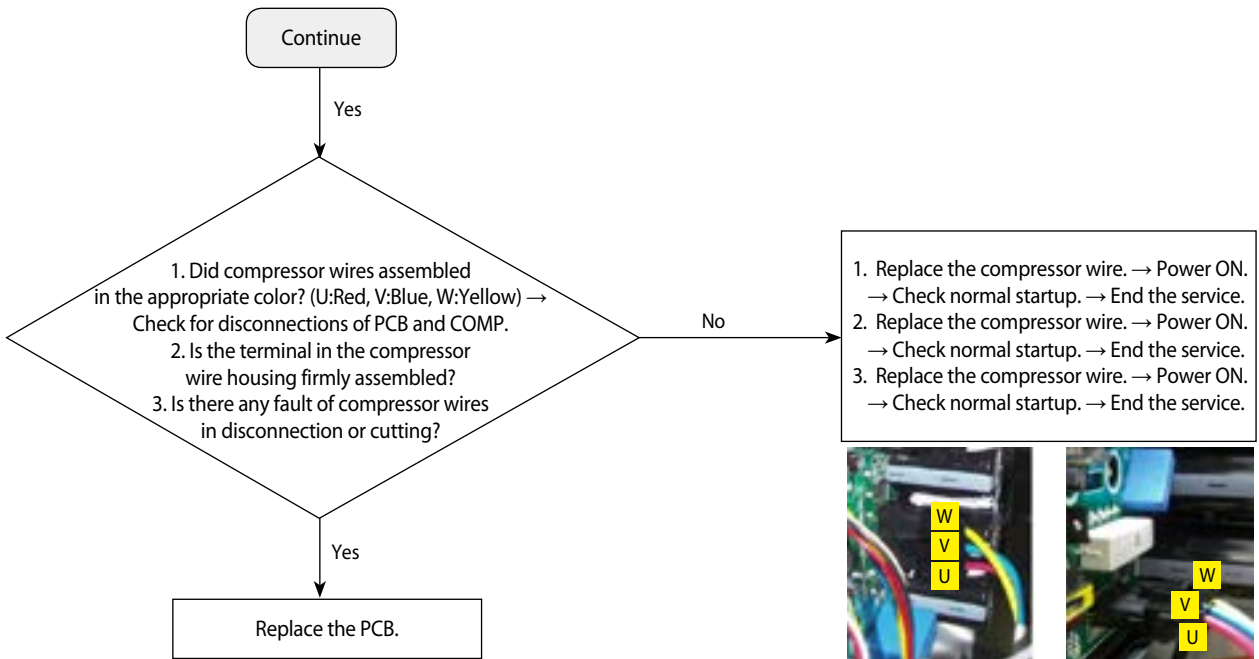

[RC\*\*\*\*HXH series]



[RC090\*\*\*\*/RC100\*\*\*\*/  
RC110\*\*\*\*/ RC130\*\*\*\*/  
RC145\*\*\*\*/RC160\*\*\*\* series]



[RC060\*\*\*\*/RC072\*\*\*\* series]



※ E46 Error-related, EMI / outdoor unit Main / Indoor unit Main PCB do not replace!  
→ This error is related to the Inverter PCB. (Not related to the above PCB)

※ Ensure that the service valve is open!  
→ When the service valve is closed, the defects may be caused by differential pressure when starting the compressor.

### 4-3-18 DC LINK over-current / low-voltage error (Error Code : E466) H/W DC\_Link Over Voltage Error (Error Code : E483) AC Input Voltage Sensor Error (Error Code : E488)

1. Test items

- 1) Check the power connection. / Check the restart after power reset.  
 → Is there a fault in input power? (Single-phase : 220Vac, 3-phase : 380Vac)  
 → Does error occur again at operation after power is reset?
- 2) Check the connection of the power, and check whether the jointed power connection exists.  
 → After having installed several units, please check that communication wires are not interchanged with piping.
- 3) Check the reactor and its connecting wires.
- 4) Check the fuses of EMI PBA.
- 5) Check the Terminal Block and Power Terminal Box and the wire assembly.

2. Check procedure

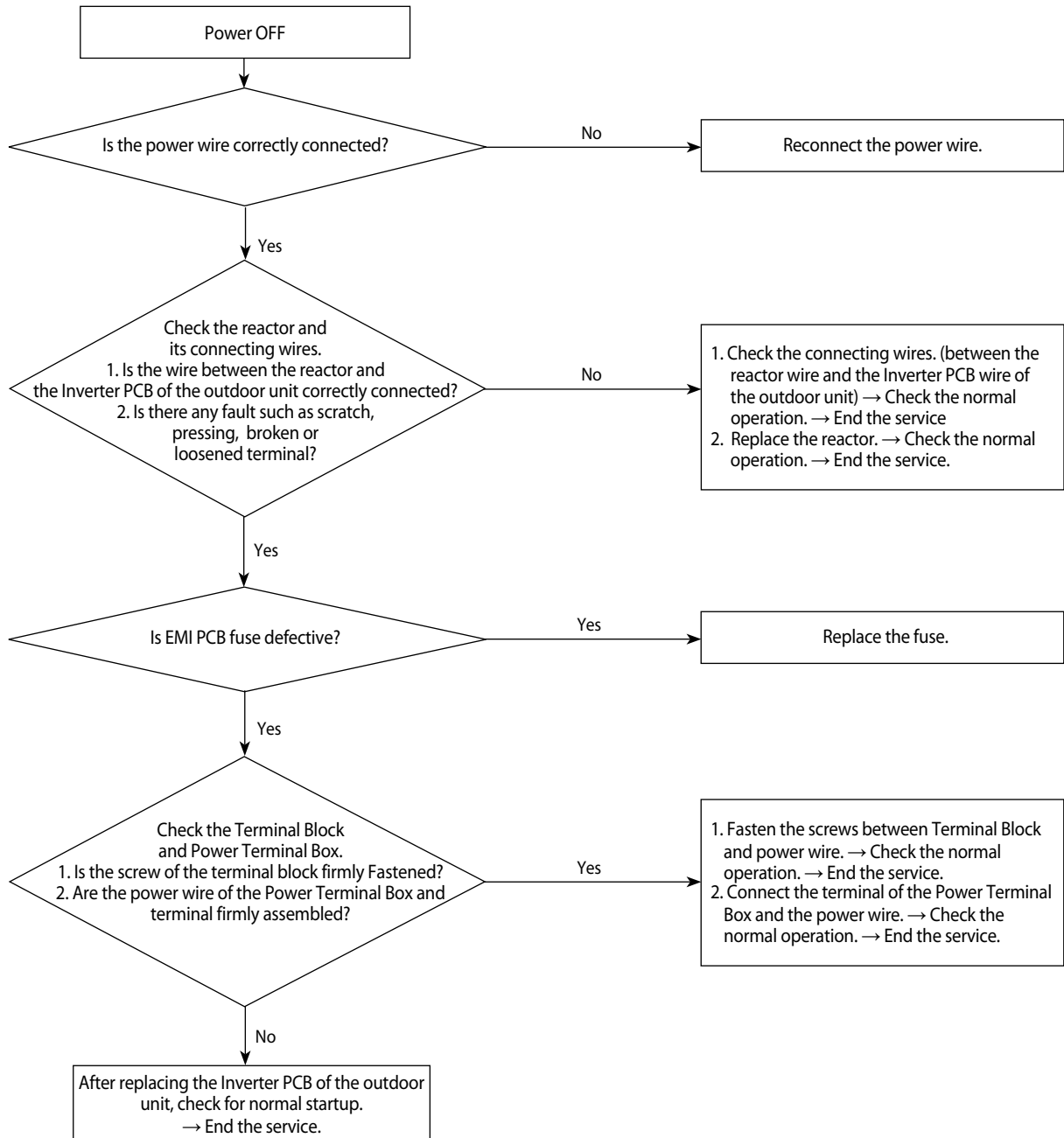

### 4-3-19 Gas leakage error(Error Code : E554)

1. Test items

- 1) Check the power connection. / Check the restart after power reset.
  - Is there a fault in input power? (Single-phase : 220Vac, 3-phase : 380Vac)
  - Does error occur again at operation after power is reset?
- 2) Check the compressor and the state of compressor wire assembling.
- 3) Check the outdoor unit installation environment.
  - Check for disconnection of the wires regarding the Inverter PCB of the outdoor unit and check the installation environment.
  - At the site where several units were installed at the same time, check whether communication wire and pipes have been wrongly connected!

2. Check procedure

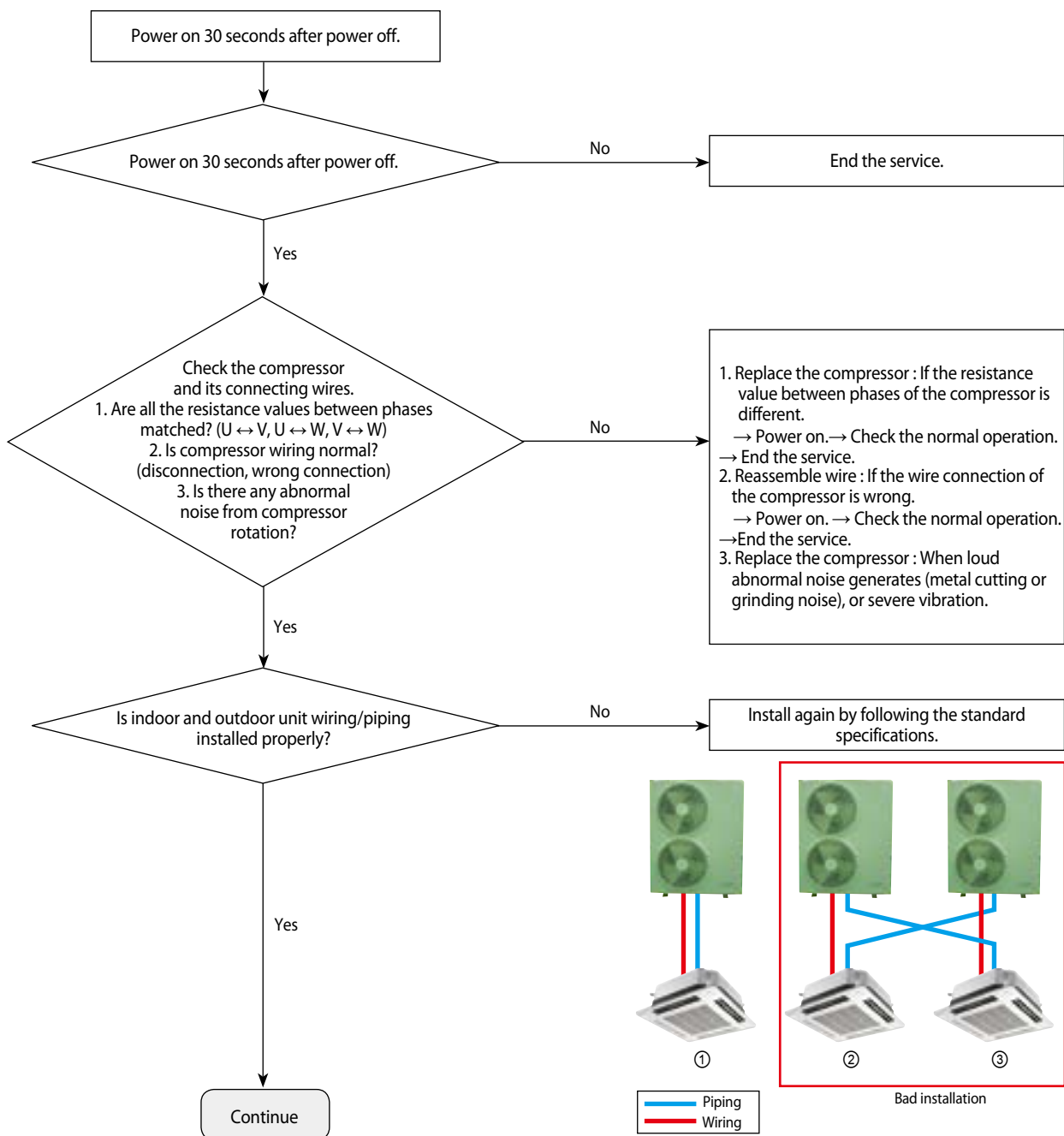

### Gas leakage error(Error Code : E554)(Cont.)

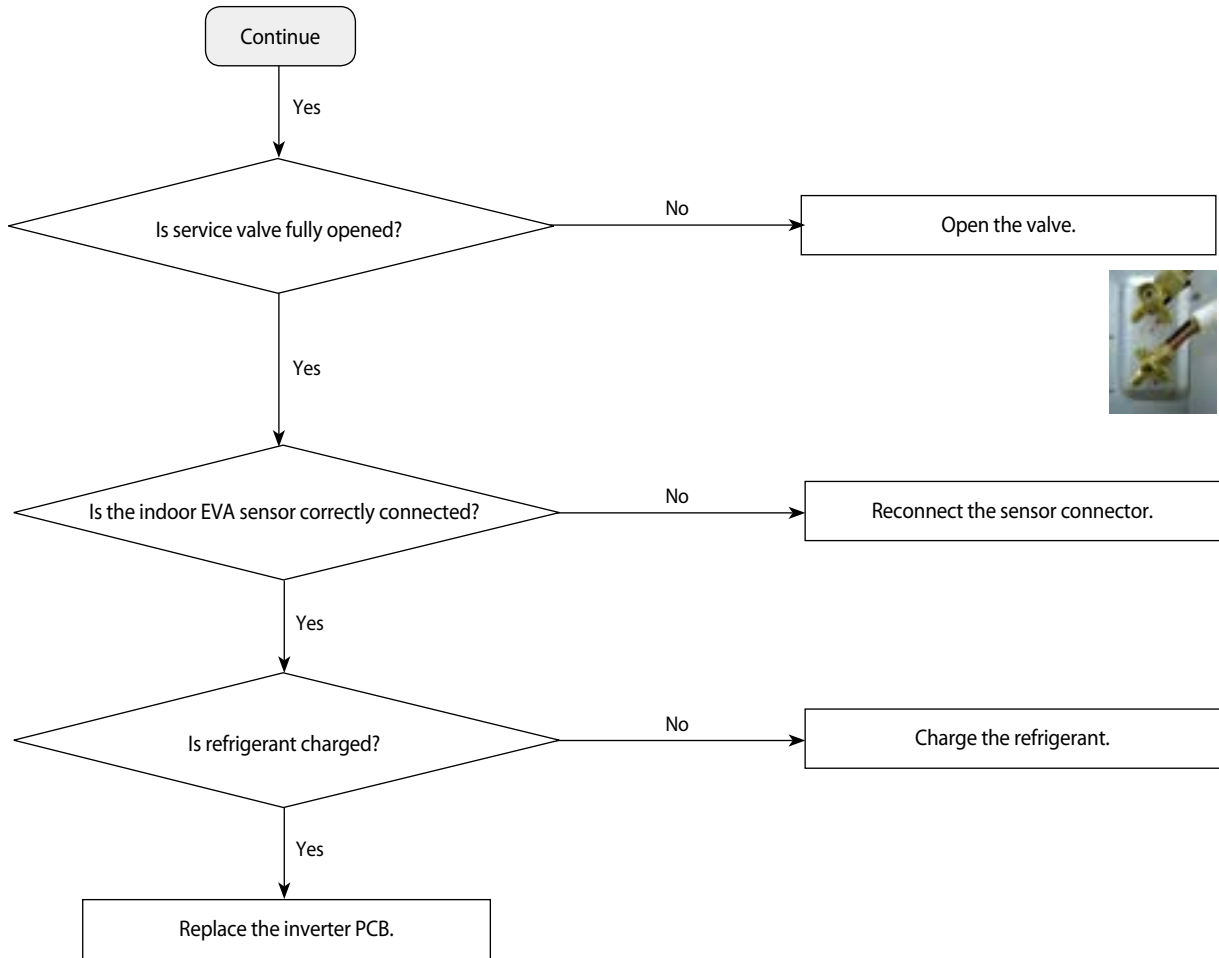

### 4-3-20 Pipe blockage error(Error Code : E422)

1. Test items
  - 1) Check the open state of the outdoor unit service valve.
  - 2) Check the connection of the pipe.
  - 3) Check the operation of the EEV.
  - 4) Check the refrigerant leakage.
  - 5) Check the connection of the indoor unit PBA EVA sensor.
  - 6) Check the fault in the indoor unit EVA sensor.
2. Check procedure

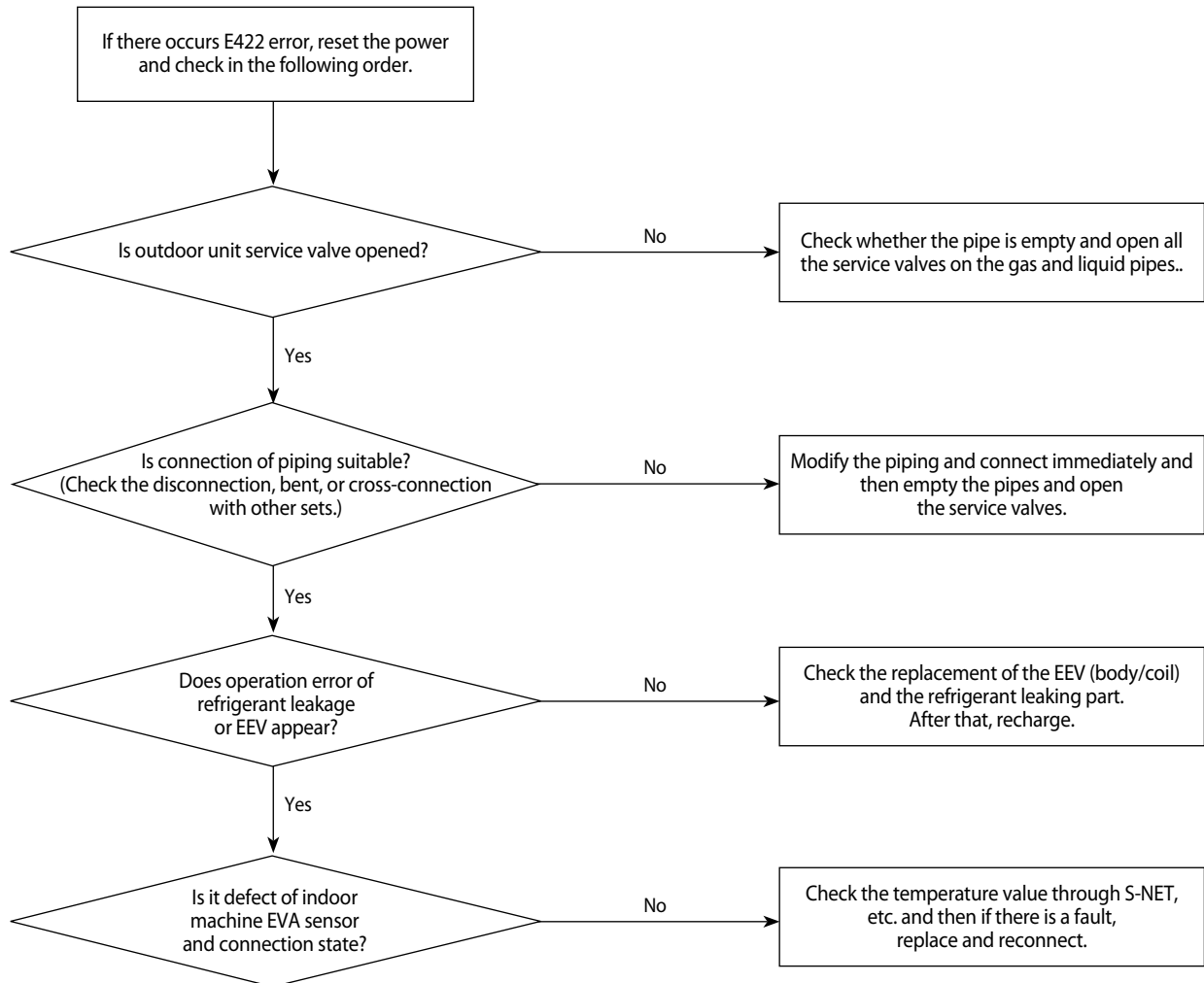



### 4-3-21 Smart install mode was not carried out(Error Code : E508 )

#### Smart install mode?

When installing the air conditioner the first time, the installation status and fault status and performance of the product is a self-diagnostic function to determine comprehensively..

(The corresponding model is necessarily the general operation can be carried out when the smart install mode.)

#### Installation procedures of smart install mode

(1) Check the installation status of air conditioner.

- ▶ Check the power wire, communication wire, power connection, service valve opening, additional amount of refrigerant.
- ▶ When supplying power upon installation, a warning (error) of not having run in the installation smart install mode is displayed and the product will not run properly.

Model	Indoor unit	Outdoor unit
360 Cassette	Red lights up	E508

(2) Enter the smart install mode.

- ▶ Enter of the outdoor unit : Press for at the same time 5 seconds K 1, K 4 switches.
- ▶ Enter of the remote control : Press for at the same time 4 seconds [Power] + [Set] + [Mode] buttons.
- ▶ The progress status of installation smart install mode is shown in "00~99"(%).
- ▶ The smart install may take about 10 minutes.

Model	Indoor unit	Outdoor unit
360 Cassette	It is blinking in sequence. (Ice blue → Yellow green → Blue → Red → Ice blue)	"F" "F" "r" "d" After lasting for 3 minutes "F" "F" "00~99" display.

(3) The installation smart install mode is complete.

- ▶ Success in the installation smart install mode : The unit will enter a general operation standby mode upon blinking to show a success.

Indoor unit	Outdoor unit
Indicator light of main unit switches off.	"F" "F" "n" "F" After blinking for 10 seconds. It will enter the general operation stand by mode.

- ▶ Smart Install failure: Error code blink

※ In the event of Error Error code reference, please carry a house from scratch after an action mode for the Smart Install Error.

## Precautions

- ▶ When needing to have additional piping before entering the installation smart install mode, charge refrigerant additionally according to the manual. At this time, it is possible to run the cooling test (K2 switch once) and heating test (K1 switch once).
  - ▶ When the installation smart Install mode is not run, the remote control and main unit button will not work. [E508 (Smart install mode was not carried out) error displayed.]
  - ▶ The installation smart install mode operation may be interrupted by pressing the K3 switch. [Display the E508 (Smart install mode was not carried out) error upon interruption.]
  - ▶ While running in the installation smart install mode, the installation smart Install mode operation may not be interrupted even by pressing the K1 or K2 switch.
  - ▶ While running in the installation smart install mode, the system status information may be checked by pressing the K4 switch.
  - ▶ When pressing the K1 and K4 switches for 5 seconds upon successfully running in the installation smart install mode, the system will run the installation smart install mode again.
  - ▶ When having an error in the installation smart install mode, operation in the installation smart install mode may be interrupted.  
Please run the installation smart install mode again upon taking appropriate action for the error. (Refer to troubleshooting)
  - ▶ When the installation smart install mode is not completed successfully even after resolving all the errors, the unit will not work, displaying an error code of E508 (Smart install mode was not carried out). Upon resolving the problem, try to complete running the installation smart install mode.
- ※ Displayed E508 is not a malfunction, it is indication that did not carried out the smart Install mode after air conditioner installation.

## 4-3-22 Others

1. EEPROM option error (E163) : Reset the options.
2. Temperature fuse error : E198
  - If the Terminal Box temperature rise fuse is disconnected, replace the PCB.
  - Check the wiring connector of temperature fuse.
3. Current sensor error : Upload EEPROM to the Main PCB of the outdoor unit.
  - After checking for normal operation of PCB, replace the inverter PCB.
4. Compressor Vlimit error : E465
  - If the compressor is abnormally run, replace the compressor and then ensure that it works normally.
  - If the compressor is normally run, check the assembling between the heatproof plate and the Inverter PCB and then if there is no abnormality, replace the Inverter PCB.
5. DC link voltage sensor error : E469
  - Error occurs when DC LINK value is not normal (DC LINK VOLTAGE: 280~320V)
  - Check the value of DC link when error occurs and check the reactor disconnection
6. EEPROM read/write error : E470
  - Error occurs when there is no EEPROM data in the set.
  - Check the model name and insert EEPROM for corresponding model or load the EEPROM data.
7. Input current sensor error : E485
  - Detect the input sensor while the set is in stop status to check if there's any problem.
  - When error occurs, turn on/off the power for number of time and if same error occurs while the power is off, replace the Inverter PCB.
8. OTP error : E471
  - Upload EEPROM to the Main PCB of the outdoor unit.
9. Capacity inconsistency error : E556
  - Check the model name between the outdoor and indoor unit and re-enter the option code to the indoor unit.
10. 3-phase power wire disconnection : E424
  - Check for disconnection of the 3-phase (open) power wire, and check the disconnected EMI PBA fuse.
11. Outdoor unit freezing detection (at the stop of the compressor) : E403  
 Outdoor overload protection control (at the stop of the compressor) : E404
  - Check whether the fan and the motor operate normally.
  - Check the operation of EEV.
  - Check the temperature sensor of the indoor unit heat exchanger.
  - Check the indoor unit inlet blockage.
12. Outdoor unit compressor discharging temperature protection control : E416
  - Check for lack of refrigerant.
  - Check the blockage of the solenoid valve.
  - Check the malfunction of the exhaust temperature sensor.
  - Check the EEV.
13. Error of impossibility to operate heating at outdoor temperature exceeding 30°C : E440  
 Error of impossibility to operate cooling at outdoor temperature of -5°C or under : E441
  - It is not the error code in the product and it is a specification to protect the product by limiting the temperature scope of use.
  - Use by referring to the temperature scope of use on the product manual, etc.
14. OLP overheating and compressor stop : E463
  - Check the opening of the sub valve.
  - Check the amount of the cooling water.
  - Check the OLP sensor.

15. Current sensor error : E468
  - Check the EEPROM data.
  - Check the PCB operation.
  
16. IPM (IGBT Module) or PFCM temperature sensor error : E474  
IPM overheat error for outdoor unit inverter compressor : E500
  - Check whether IPM is correctly assembled on the heatproof plate.
  - Check whether the inlet is blockage.
  - If there is a defect, replace the IPM.

## 5. PCB Diagram and Parts List

### 5-1 Indoor Unit

#### 5-1-1 MAIN PCB

■ AC018/024/030/036/042/48NN4DCH

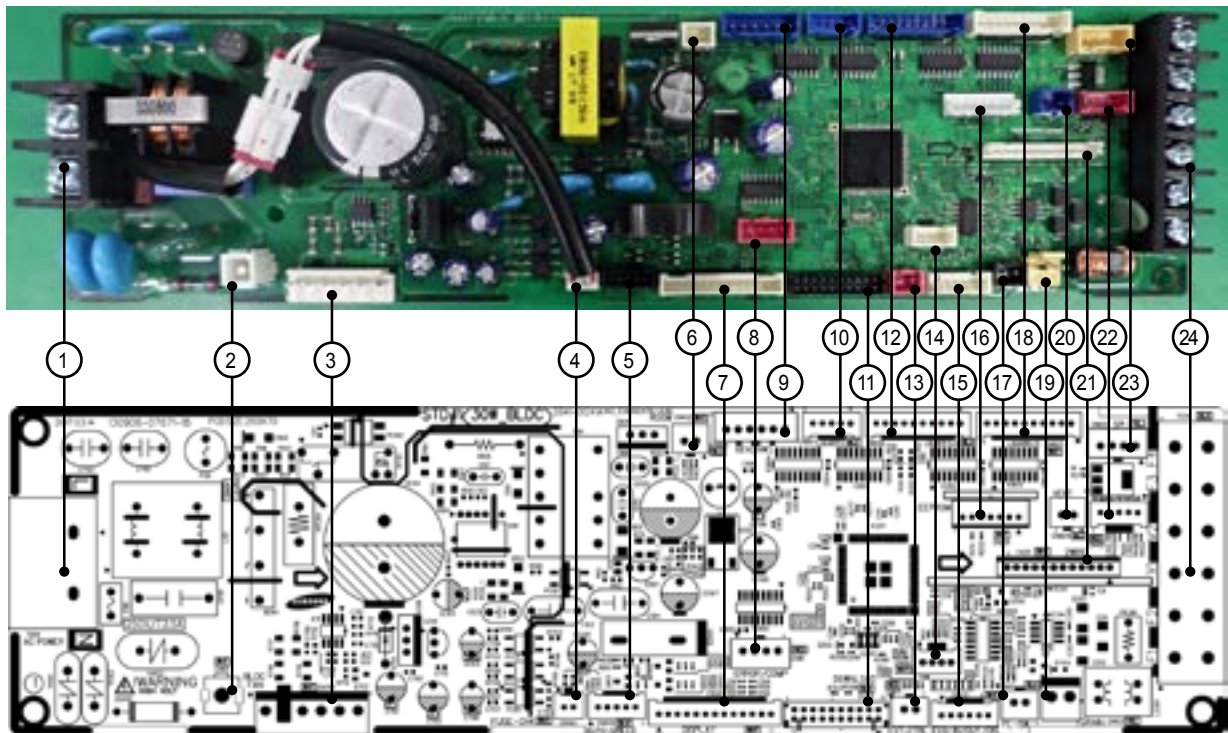

This Document can not be used without Samsung's authorization.

① <b>TB101-AC 전원</b> #1: AC POWER (L) #2: AC POWER (N)	② <b>CN101-EARTH</b> #1: EARTH	③ <b>CN701-BLDC MOTOR</b> #1: DC310V #3: GND #4: DC15V #5: FAN RPM #6: RPM FEEDBACK	④ <b>CN140-FUSE CHECK</b> #1: FUSE CHECK Signal #2: GND	⑤ <b>CN809-AUTO GRILLE</b> #1: DC12V #4: REMOCON OUT #5: GND
⑥ <b>CN412-ROOM SENSOR</b> #1: ROOM SENSOR #2: GND	⑦ <b>CN501-DISPLAY</b> #1: DC12V #2: LED_0 #3: LED_1 #4: LED_2 #5: LED_3 #6: LED_4 #7: LED_5 #8: REMOCON OUT #9: AUTO SWITCH #10: REMOCON IN #11: GND #12: DC5V #13: GND	⑧ <b>CN81-COMP/ERROR MONITOR</b> #1: DC12V #2: ERROR OUT (GND) #3: DC12V #4: COMP/OPER. OUT (GND)	⑨ <b>CN808-EEV</b> #1~#4: EEV SIGNAL #5: DC12V #6: DC12V	⑩ <b>CN807-LOUVERS</b> #1: DC12V #2~#5: LOUVER SIGNAL
⑪ <b>CN301-DOWNLOAD</b>	⑫ <b>CN806-LOUVER3/4</b> #1: DC12V #2~#5: LOUVER SIGNAL #6: DC12V #7~#10: LOUVER SIGNAL	⑬ <b>CN83-EXT CTRL</b> #1: GND #2: EXTERNAL CONTROL SIGNAL	⑭ <b>CN414-HUMIDITY SENSOR</b> #1: DC5V #2: GND #3: THERMISTOR SENSOR #4: HUMIDITY SENSOR	⑮ <b>CN413-THERMISTOR</b> #1: EVA-IN SENSOR #2: GND #3: EVA-OUT SENSOR #4: GND #5: DISCHARGE SENSOR #6: GND
⑯ <b>CN201-EEPROM</b> #1: GND #3: DC5V #4: EEPROM_SELECT #5: EEPROM_SO #6: EEPROM_SI #7: EEPROM_CLK	⑰ <b>CN411-FLOAT SWITCH</b> #1: FLOAT SWITCH SIGNAL #2: GND	⑱ <b>CN805-LOUVER1/2</b> #1: DC12V #2~#5: LOUVER SIGNAL	⑲ <b>CN103-DRAIN PUMP</b> #1: DRAIN PUMP (DC12V) #2: GND	⑳ <b>CN804-VENTILATOR</b> #1: DC12V #2: VENT SIGNAL OUTPUT(GND)
㉑ <b>CN311-2 WIRED SUB</b>	㉒ <b>CN401-HUMAN SENSING</b> #1: DC12V #2: MAIN-HUMAN SENSOR COMM(TXD) #3: MAIN-HUMAN SENSOR COMM(RXD) #4: GND	㉓ <b>CN801-SPI</b> #1: GND #2: GND #3: SPI SIGNAL (DC12V)	㉔ <b>TE04-COMMUNICATION</b> #1: COM1(F1) #2: COM1(F2) #3: V1(DC12V) #4: V2(GND) #5: COM2(F3) #6: COM2(F4)	

### 5-1-2 Panel Display PCB

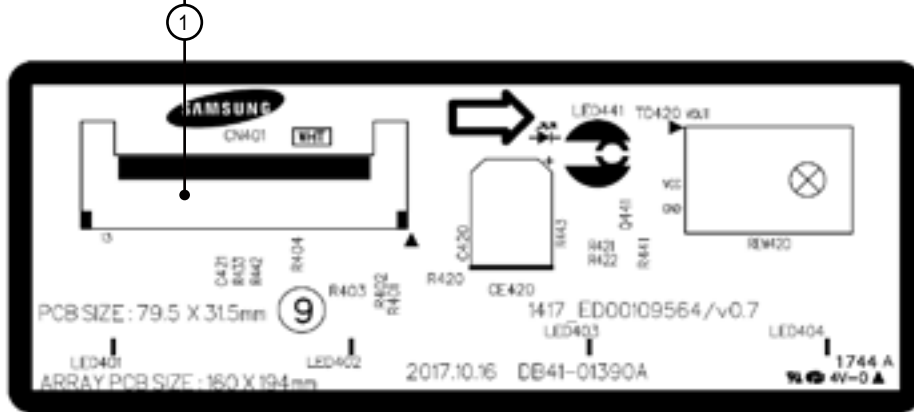
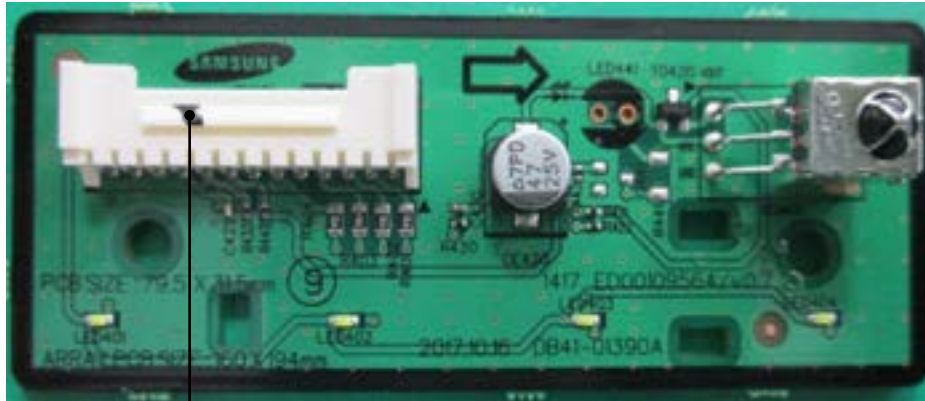

- |      |                     |
|------|---------------------|
| ①    | <b>CN01-DISPLAY</b> |
| #1:  | DC12V               |
| #2:  | LED_Operation       |
| #3:  | LED_Defrost         |
| #4:  | LED_Timer           |
| #5:  | -                   |
| #6:  | LED_Filter          |
| #7:  | -                   |
| #8:  | Remocon Signal Out  |
| #9:  | Panel Select        |
| #10: | Remocon Signal In   |
| #11: | GND                 |
| #12: | DC5V                |
| #13: | -                   |

This Document can not be used without Samsung's authorization.

## 5-2 Outdoor Unit

### 5-2-1 Main PCB

#### ■ AC018JXADCH

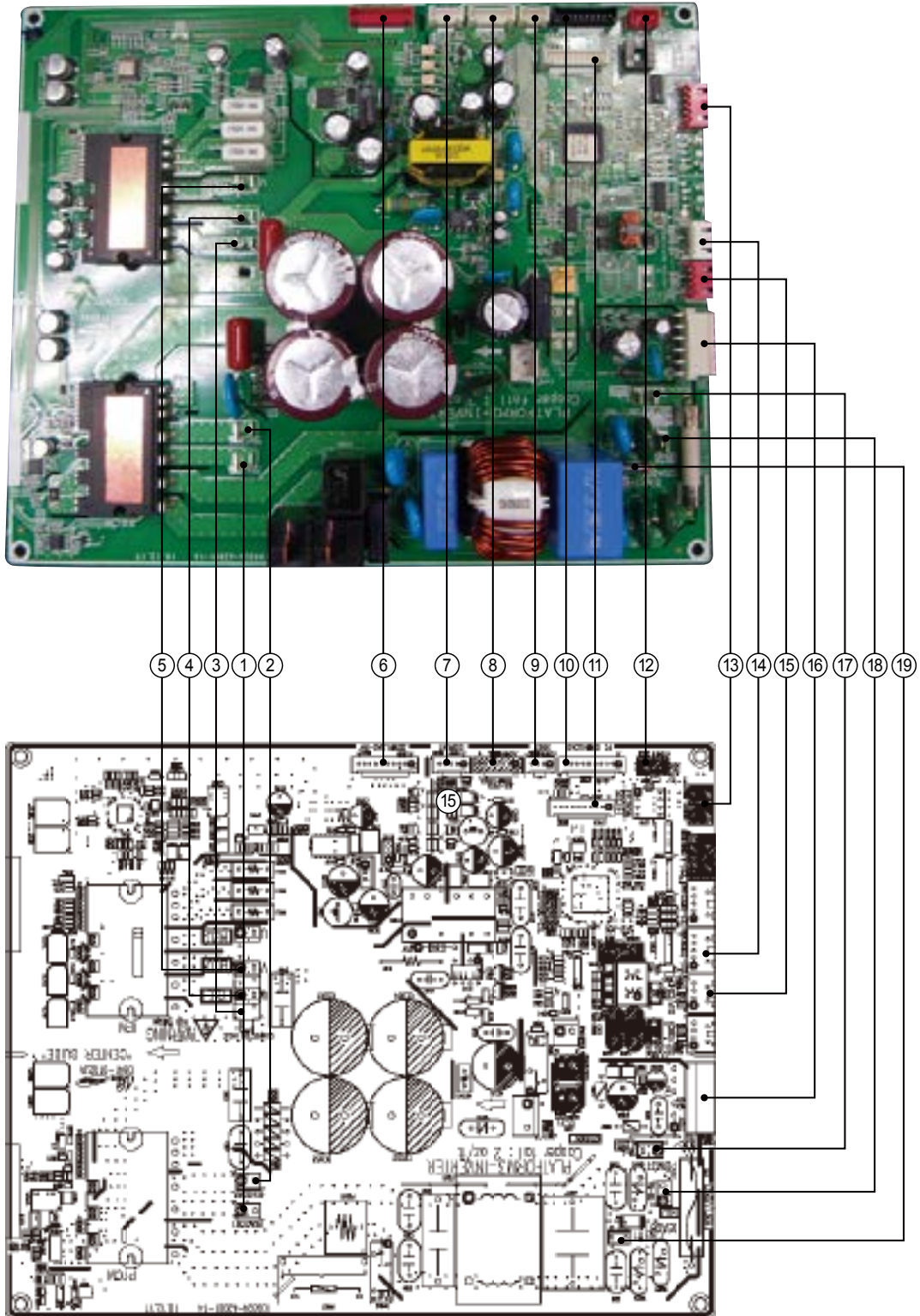



① <b>Reactor1</b> #Reactor1	② <b>Reactor2</b> #Reactor2	③ <b>Comp. W</b> #Comp. W : YEL	④ <b>Comp. V</b> #Comp. V : BLU
⑤ <b>Comp. U</b> #Comp. U : RED	⑥ <b>CN201-Download-Inv</b> #1 : RXD_ATARO #2 : TXD_ATARO #3, #8 : N.C #4~#7 : DATA signal #9 : GND #10 : DC 5V	⑦ <b>CN507-Display</b> #1 : Key switch #2~#5 : Data signal	⑧ <b>CN511-AS-PRO</b> For S/W engineer debugging
⑨ <b>CN510-SNET</b> #1 : DC 12V #2 : RXD #3 : TXD #4 : GND	⑩ <b>CN512-PC Download</b> #1 : RXD_INV #2 : TXD_INV #3, #8 : N.C #4 ~ #7 : Data signal #9 : GND #10 : DC 5V	⑪ <b>CN506-Display</b> #1~#7 : 7-segment signal #8~#10 : Key switch	⑫ <b>CN513-RAC Detect</b> #1 : DC 5V #2 : Detect signal #3 : GND
⑬ <b>CN503-EEV A</b> #1~#4 : Motor signal #5 : DC 12V	⑭ <b>CN501-Sensor</b> #1~#2 : OLP Temp. #3~#4 : Cond. Temp.	⑮ <b>CN502-Sensor</b> #1~#2 : Outdoor Temp. #3~#4 : Discharge Temp.	⑯ <b>CN901-BLDC FAN</b> #1 : DC 360V #2 : N.C #3 : GND #4 : DC 15V #5 : FAN RPM #6 : FAN RPM feedback
⑰ <b>TB-L</b> #AC Power(220V) : L	⑱ <b>TB-N</b> #AC Power(220V) : N	⑲ <b>EARTH</b> #Earth	

## 5-2-2 SUB PCB

### ■ AC018JXADCH

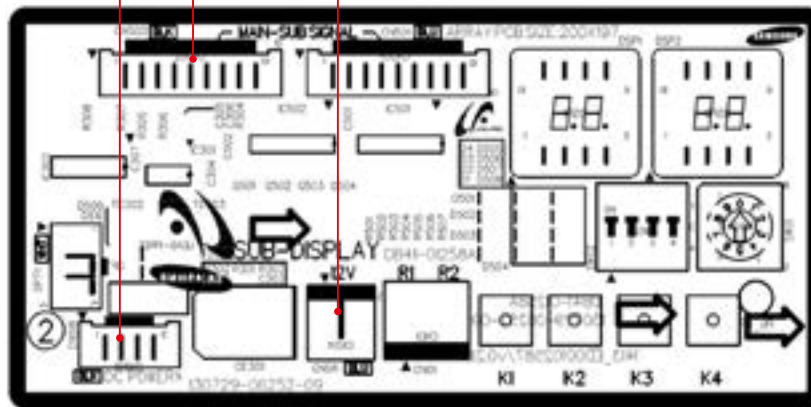
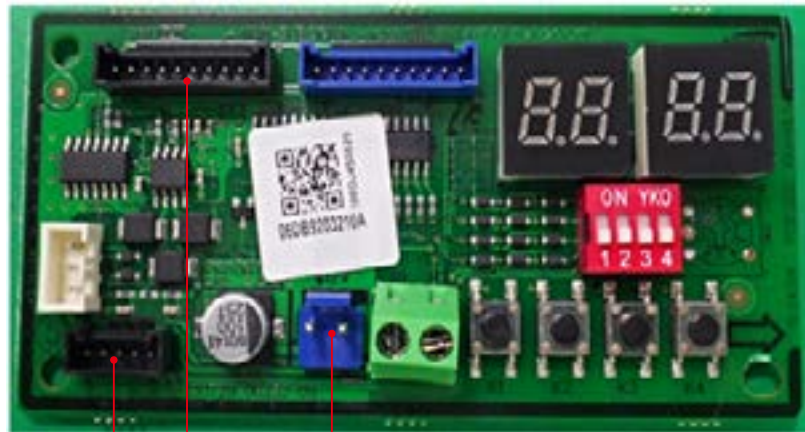

<p>① <b>CN22-Display</b>                      #1-#7 : 7-Segment signal                      #8-#11 : Key switch signal                      #12-#15 : Data signal</p>	<p>② <b>CN21-DC POWER and AWAKE</b>                      #1 : DC 12V                      #2 : GND                      #3-#4 : Awaken key</p>	<p>③ <b>CN511-DC Power</b>                      #1 : DC 12V                      #2 : GND</p>
---	--	---

### 5-2-3 MAIN PCB

#### ■ AC024JXADCH, AC030JXADCH, AC036JXADCH, AC042JXADCH, AC048JXADCH

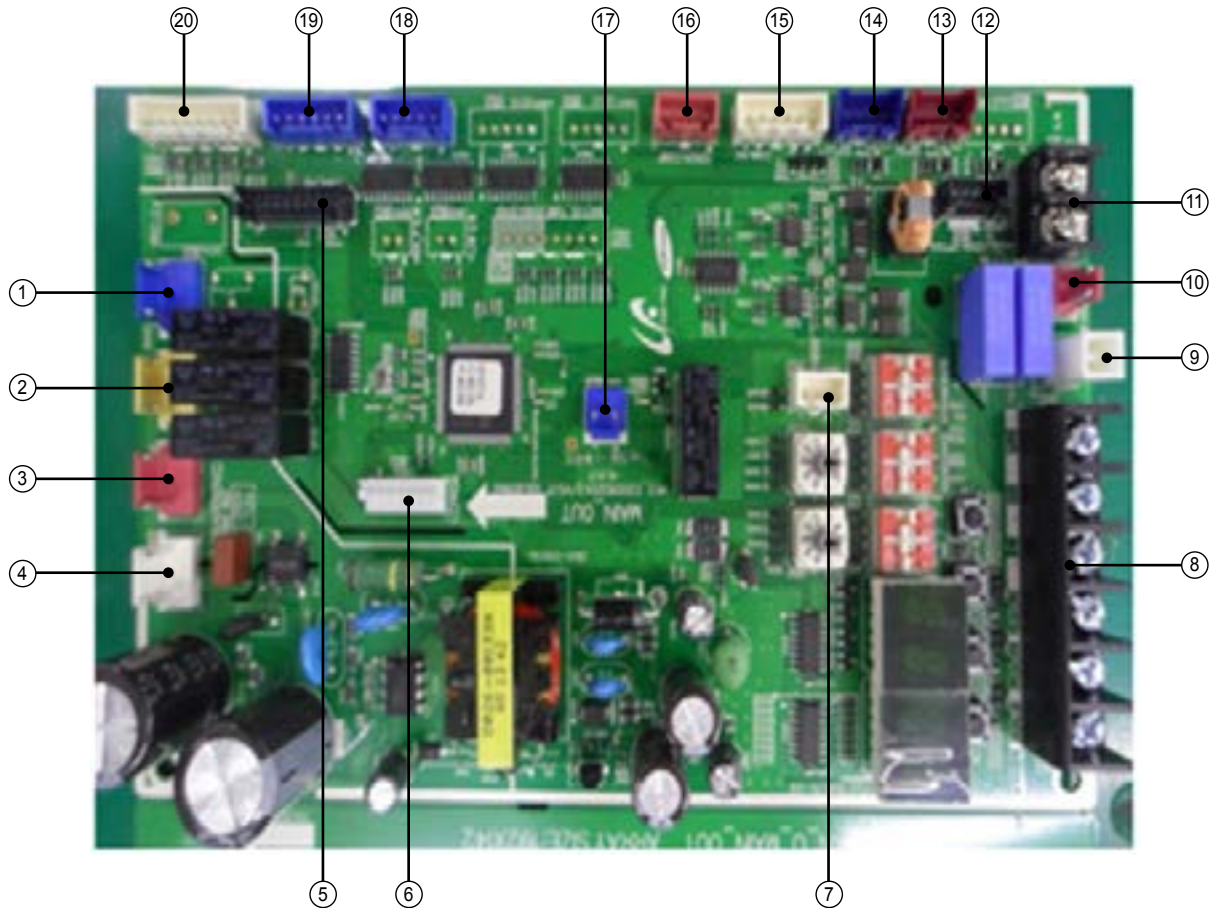

No	Part Code	Local	Function	Description
1	3711-003404	CN703	BASE-HEATER	YW396-03AV BLU
2	3711-003406	CN702	4WAY-1	YW396-03AV YEL
3	3711-003407	CN701	HOTGAS	YW396-03AV RED
4	3711-002023	CN101	POWER	YW396-03AV WHT
5	3711-002001	CN306	DOWNLOAD	YDW200-20P BLK
6	3711-007817	CN806	EEPROM	B7P-MQ WHT
7	3711-000024	CN501	MODE SELECTOR	SMW250-03 WHT
8	DB65-00320A	CN304	DRED	DAPC-2009-6P BLK
9	3711-000744	CN103	EARTH	YDW236-01 WHT
10	3711-000177	CN303	COMM-INDOOR	YW396-02V RED
11	3716-001162	CN003	QUIET S/W	BR-7623-2P BLK
12	3711-005096	CN302	COMM-OPTION	SMW200-05 BLK
13	3711-007069	CN402	HIGH PRESSURE S/W	B04B-XARK-1 RED
14	3711-007325	CN401	LOW PRESSURE S/W	B04B-XARK-1 BLU
15	3711-001038	CN305	COMM INV	SMW250-06 WHT
16	3711-000939	CN801	ERROR/COMP CHECK	SMW250-04 RED
17	3711-000176	CN12	DC12V	YW396-02V BLU
18	3711-000997	CN803	EEV1	SMW250-05 BLU
19	3711-001036	CN802	EEV4	SMW250-06 BLU
20	3711-001084	CN403	OUT TEMP/COND/DISQ/OLP	SMW250-08 WHT

### 5-2-4 INVERTER PCB

#### ■ AC024JXADCH, AC030JXADCH, AC036JXADCH, AC042JXADCH, AC048JXADCH

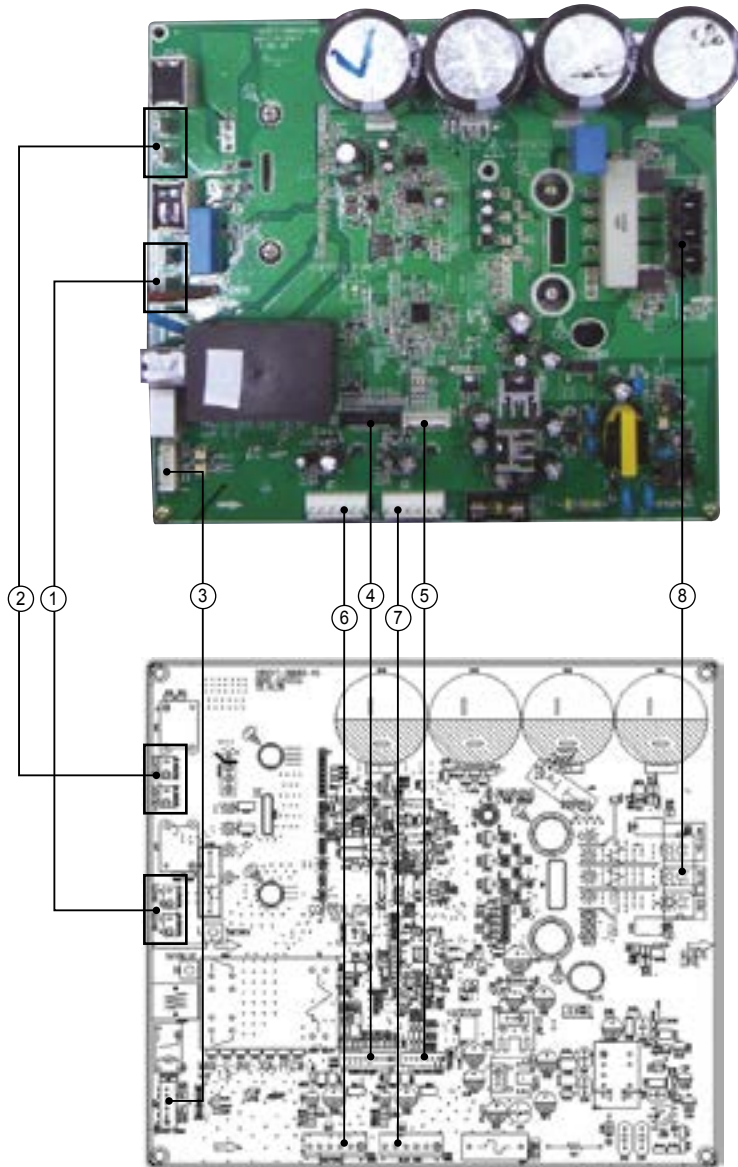

<p>① <b>Reactor-A1/B1</b> #Reactor-A2 : WHT #Reactor-B2 : WHT</p>	<p>② <b>Reactor-A2/B2</b> #Reactor-A2 : BLK #Reactor-B2 : BLK</p>	<p>③ <b>CN50(2PIN/RED)-Communication</b> #1 : RXD, #2 : TXD #3 : GND, #4 : DC 5V #5 : DC 12V, #6 : INV. SMPS signal</p>	<p>④ <b>CN22-Downloader</b> #1 : RXD_ATARO, #2 : TXD_ATARO #3, #8 : N.C, #4~#7 : DATA signal #9 : GND, #10 : DC 5V</p>
<p>⑤ <b>CN21-DAC/ENCODER</b> For S/W engineer debugging</p>	<p>⑥ <b>CN91-FAN2</b> #1 : DC 360V #2 : N.C #3 : GND #4 : DC 15V #5 : FAN RPM #6 : FAN RPM feedback</p>	<p>⑦ <b>CN90-FAN1</b> #1 : DC 360V #2 : N.C #3 : GND #4 : DC 15V #5 : FAN RPM #6 : FAN RPM feedback</p>	<p>⑧ <b>CN71-COMP.</b> #1 : COMP. U-phase(RED) #2 : COMP. V-phase(BLU) #3 : COMP. U-phase(YEL)</p>

### 5-2-5 EMI PCB

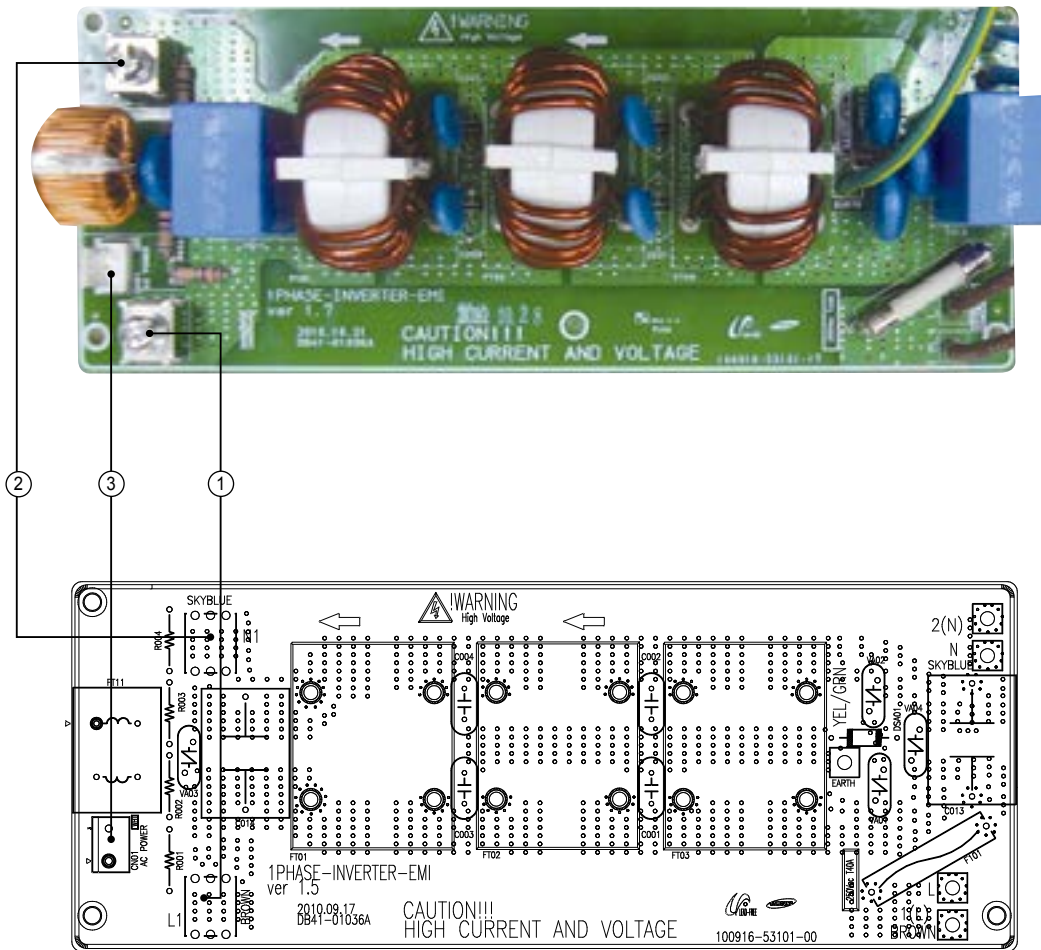

<p>① <b>L1-AC POWER L phase</b> L1 : BRN</p>	<p>② <b>N1-AC POWER N phase</b> N1 : SKY-BLU</p>	<p>③ <b>CN01-AC POWER</b> #1-#3 : AC 220~240V</p>
--	--	---

This Document can not be used without Samsung's authorization.

### 5-2-6 Heater PCB

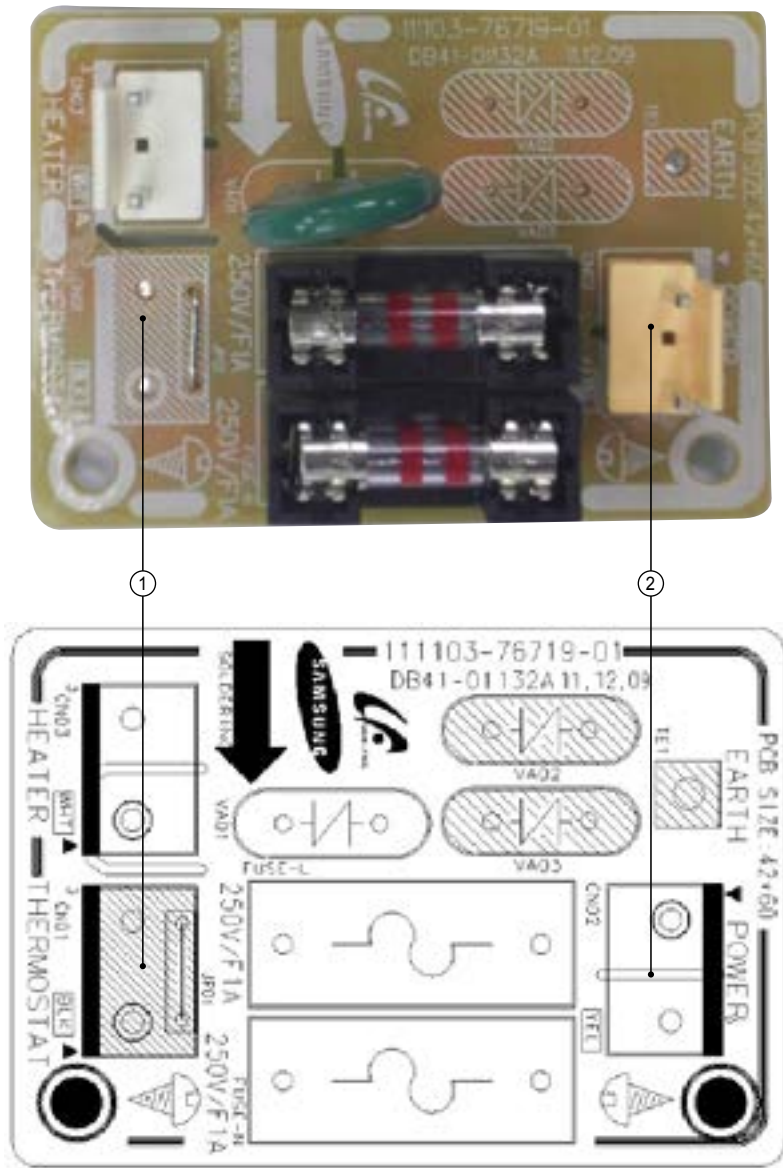

<p>① <b>AC POWER INPUT</b>                  #1 AC POWER LINE - LIVE                  #2 AC POWER LINE - NEUTRAL</p>	<p>② <b>AC POWER OUTPUT</b>                  #1 AC POWER LINE - LIVE                  #2 AC POWER LINE - NEUTRAL</p>
---	--

# 6. Wiring Diagram

## 6-1 Indoor Unit

■ AC018/024/030/036/042/48NN4DCH

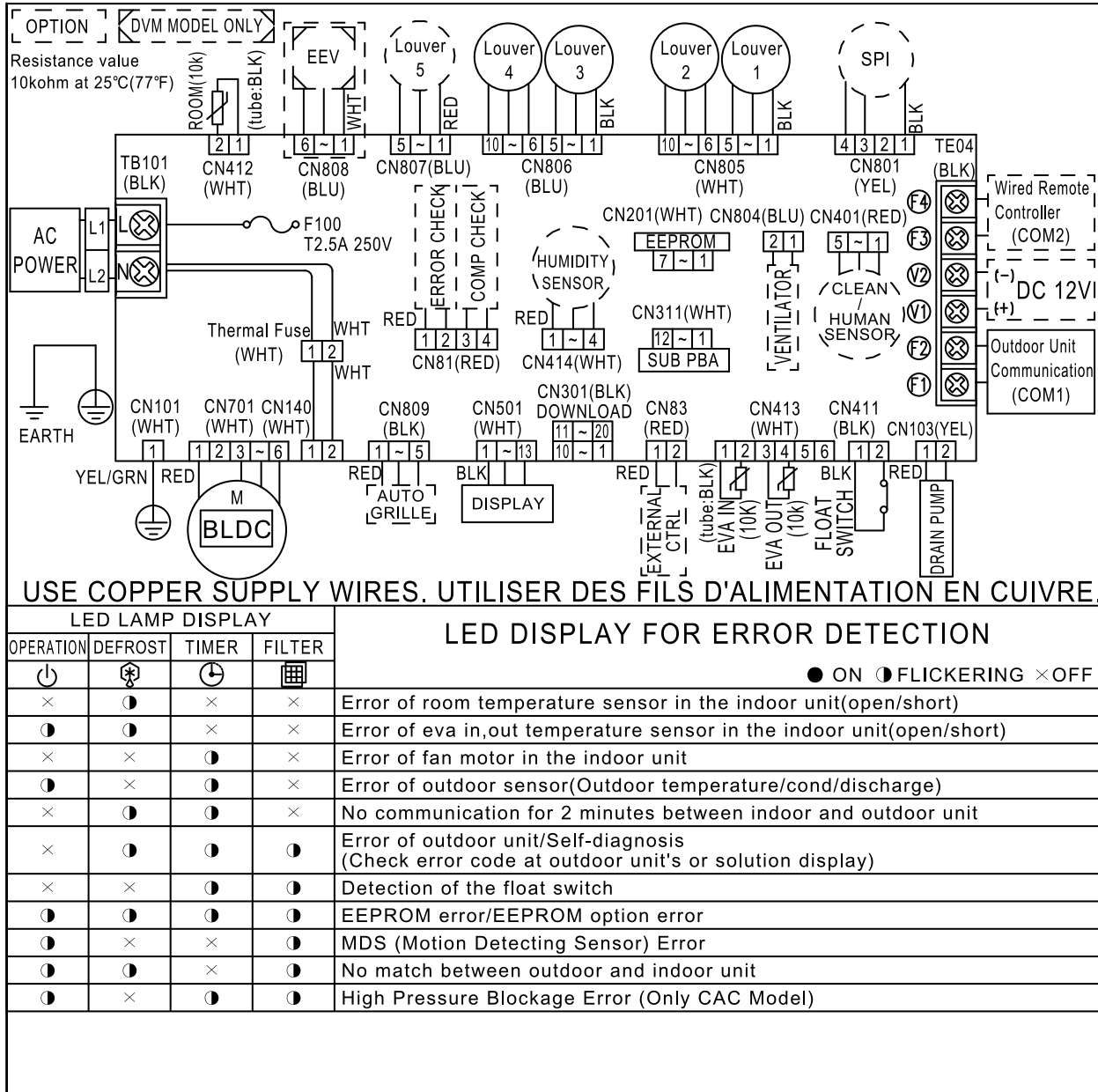

This Document can not be used without Samsung's authorization.

## 6-2 Outdoor unit

### ■ AC018JXADCH

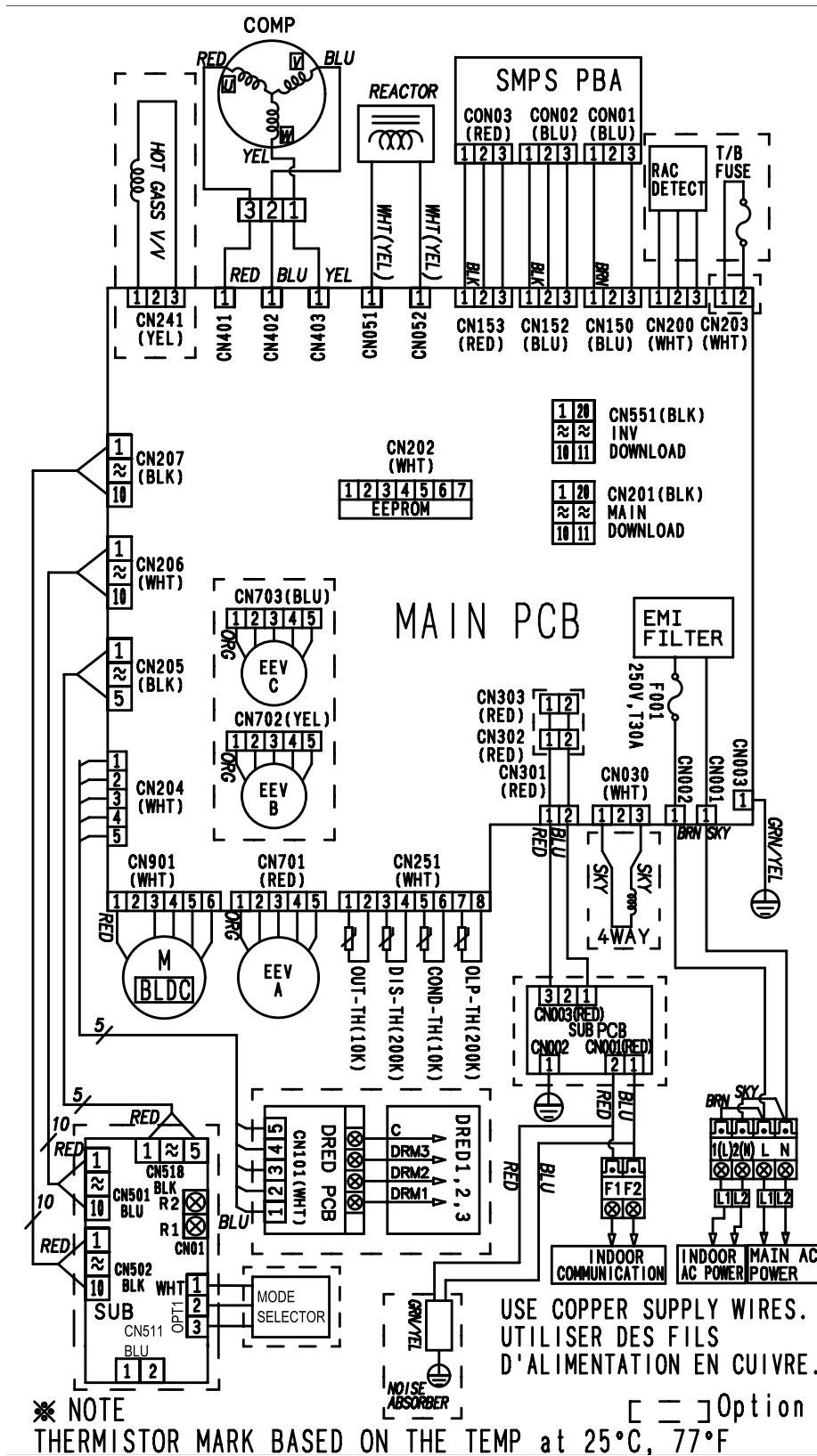

This Document can not be used without Samsung's authorization.



■ AC024JXADCH, AC030JXADCH, AC036JXADCH, AC042JXADCH, AC048JXADCH

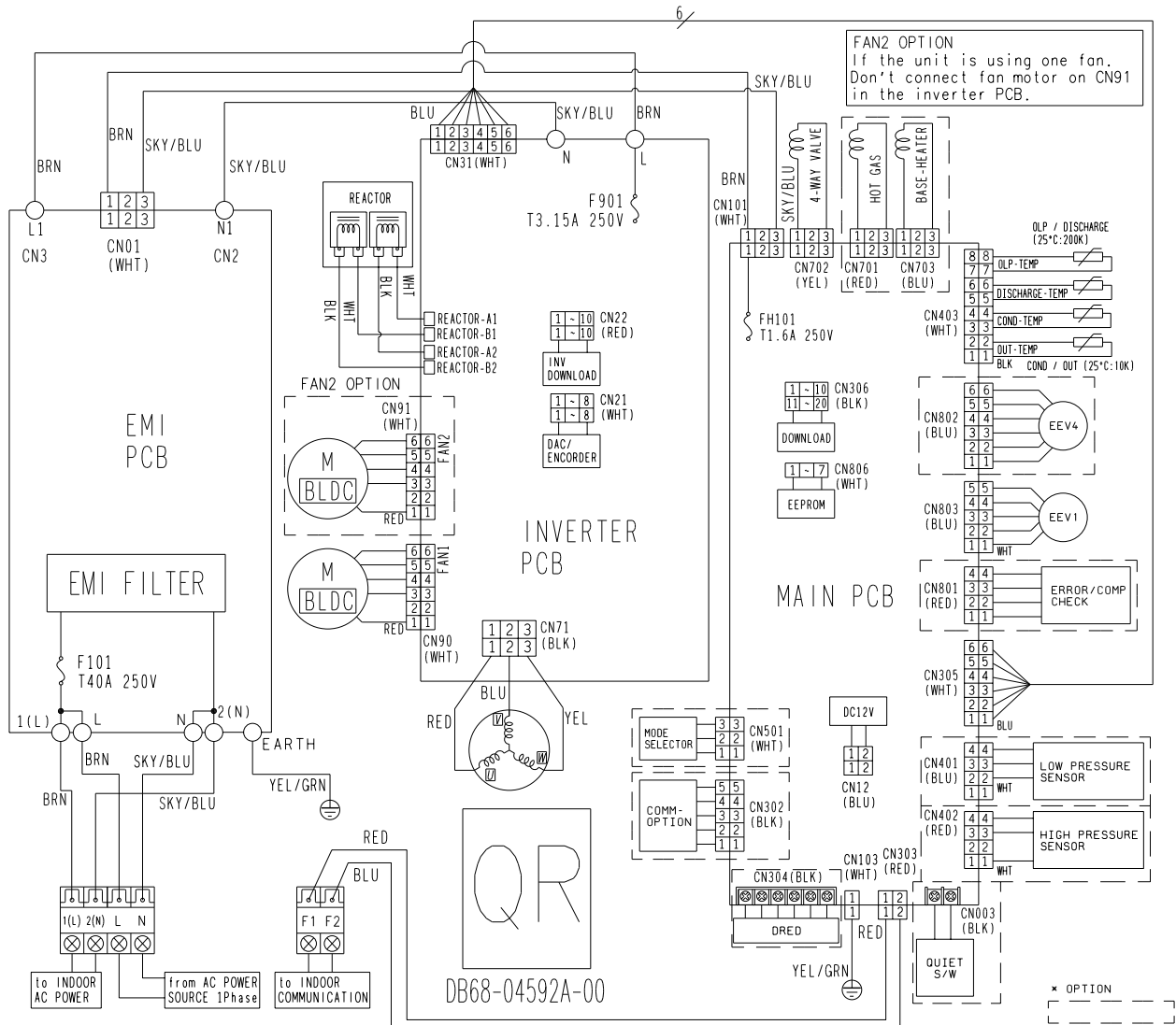

This Document can not be used without Samsung's authorization.

# 7. Reference Sheet

## 7-1 Index for Model Name

### 7-1-1 Indoor Unit

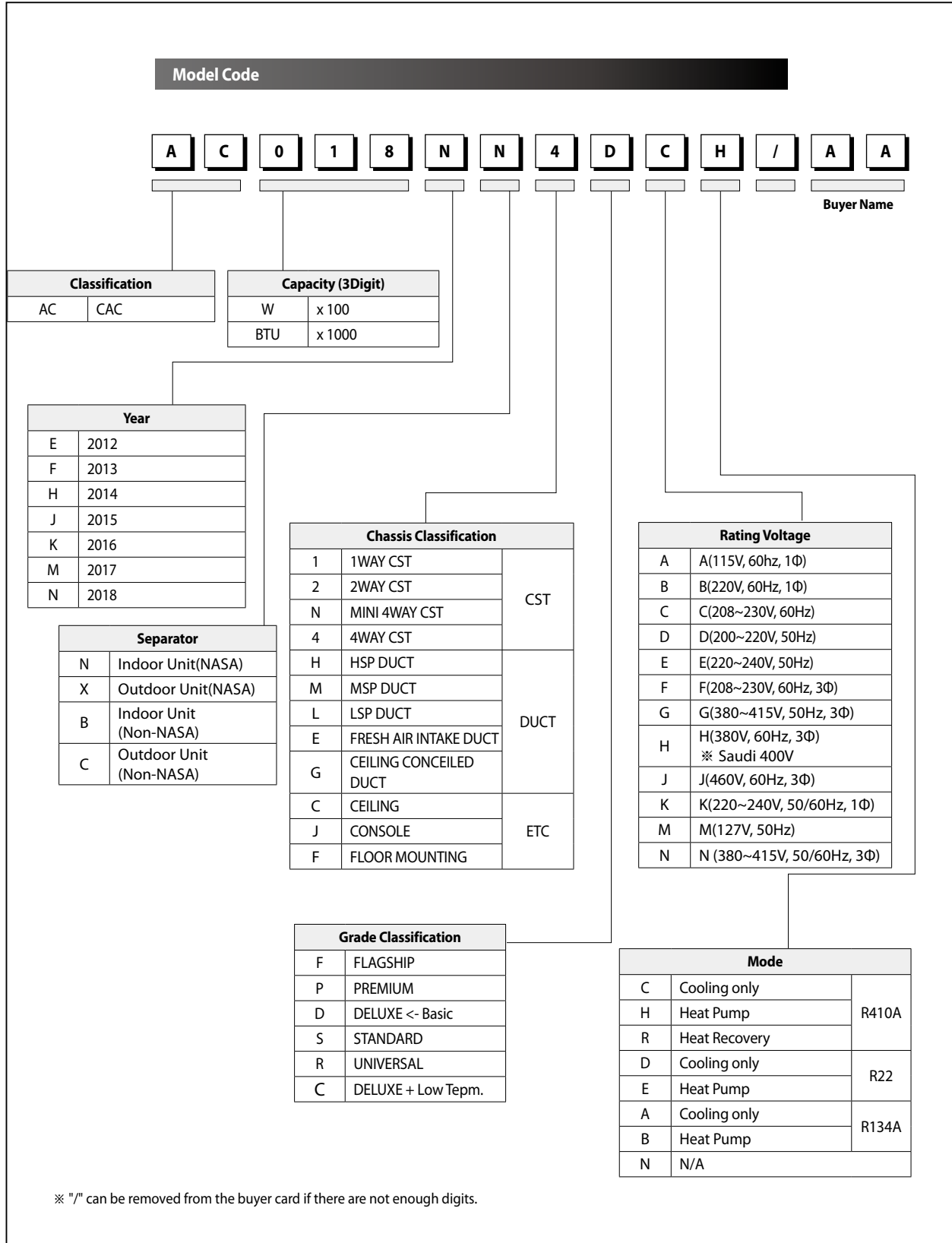

## Index for Model Name (cont.)

### 7-1-2 Outdoor Unit

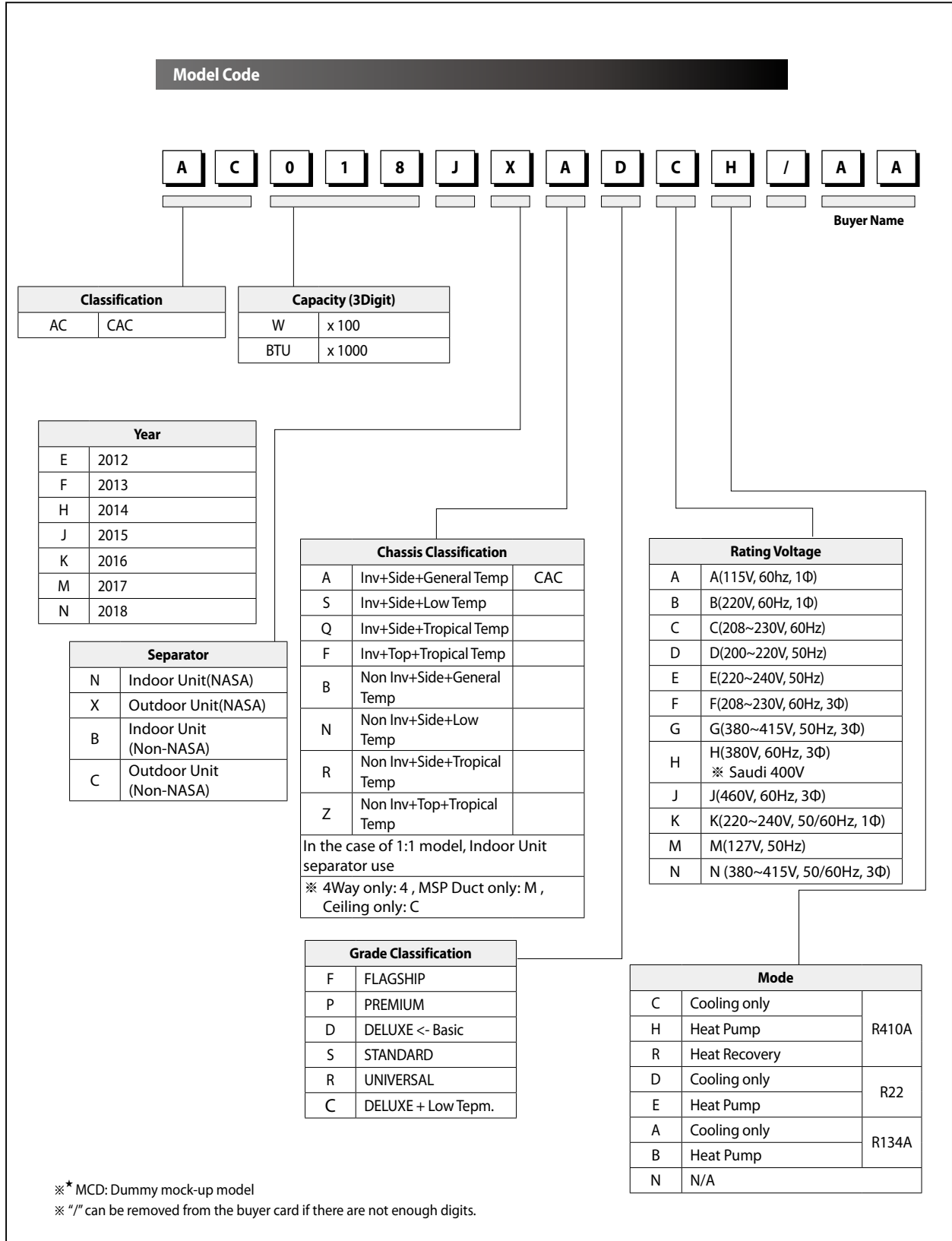

## Index for Model Name (cont.)

### 7-1-3 Panel

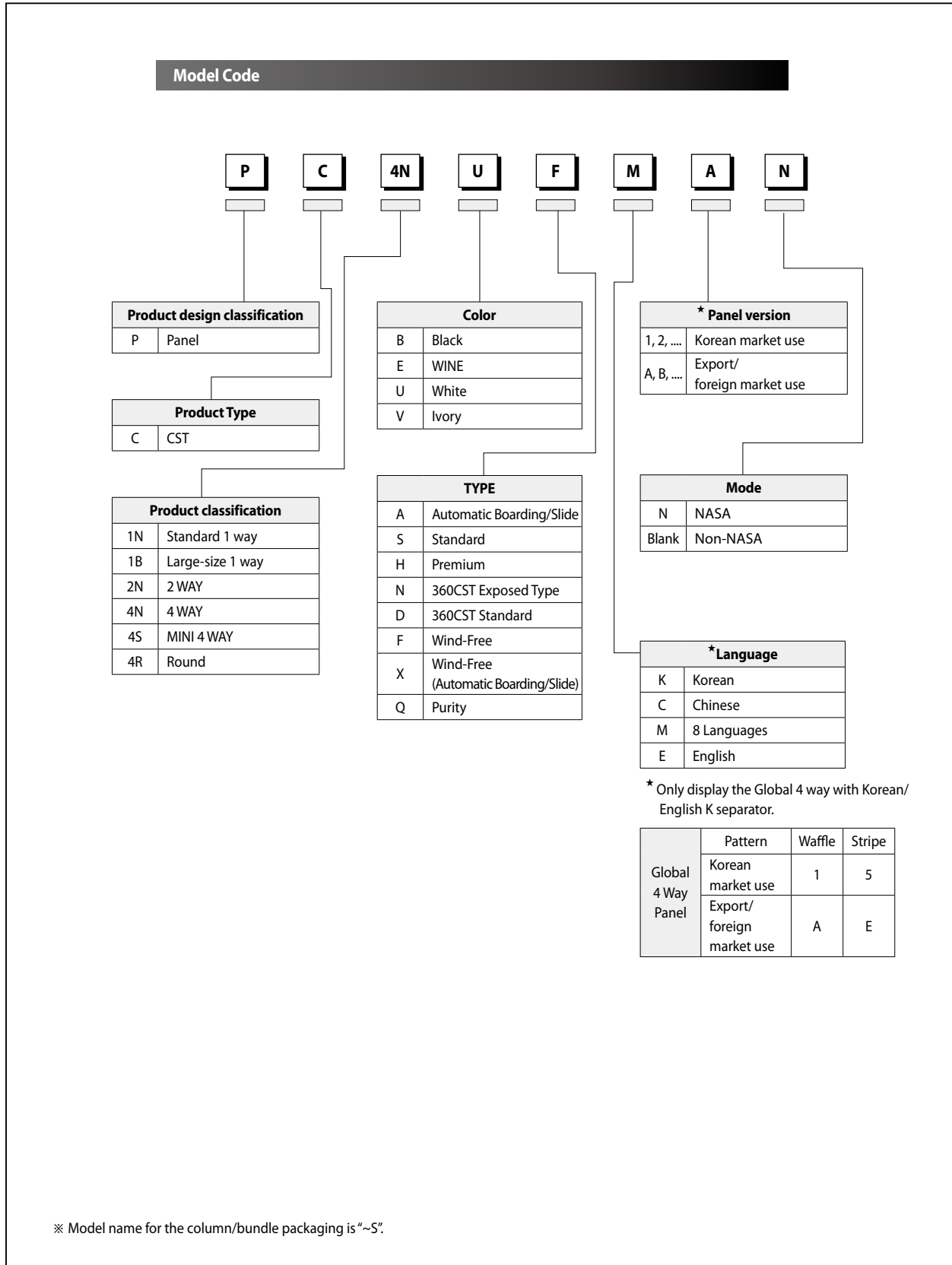

## 7-2 Refrigerating Cycle Diagram

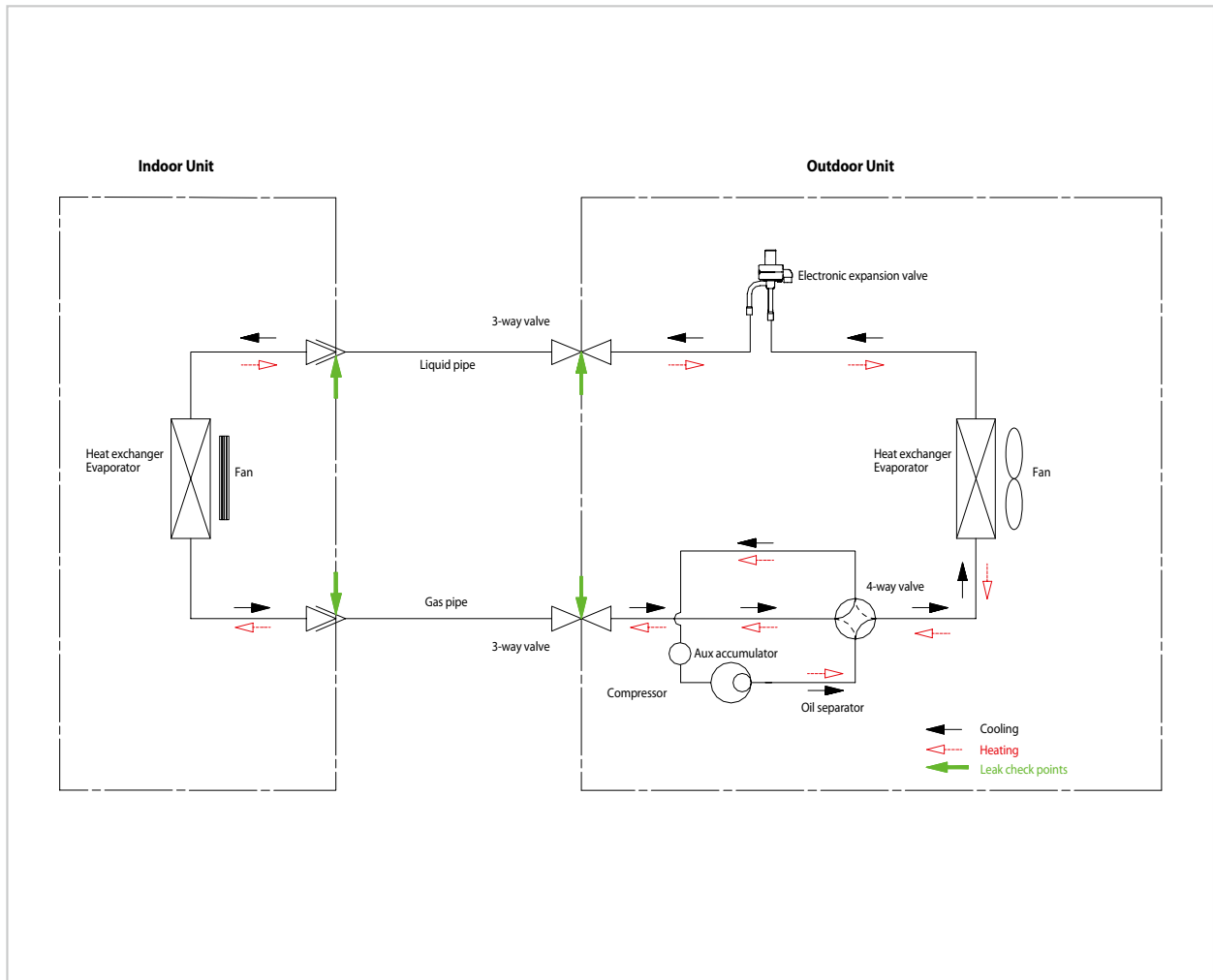

### ■ CONDENSER

High temperature and high pressure gas state coolant discharged from the compressor is converted to a liquid state as it is cooled down by the heat emission in the outdoor condenser unit, and sent to the evaporator.

### ■ COMPRESSOR

Low temperature and low pressure coolant is compressed and sent to the cycling system

### ■ EVAPORATOR

Liquid coolant sucked in through the capillary tubes cools down the room by absorbing the surrounding heat as it evaporates (converting from liquid to gas). (Absorbing heat required for evaporation)

### ■ SERVICE VALVE

You can open the valve by turning the need valve counterclockwise using hex wrench, and it is used for vacuum, gas purging, coolant injection, coolant purging, and indoor-outdoor unit connection.

### ■ ACCUMULATOR

Accumulator prevents the flow of liquid-state coolant into the compressor. (Liquid-state coolant flowing into the compressor will overload the compressor.)



### **GSPN (GLOBAL SERVICE PARTNER NETWORK)**

<b>Area</b>	<b>Web Site</b>
Europe, CIS, Mideast & Africa	<a href="http://gspn1.samsungcsportal.com">gspn1.samsungcsportal.com</a>
Asia	<a href="http://gspn2.samsungcsportal.com">gspn2.samsungcsportal.com</a>
North & Latin America	<a href="http://gspn3.samsungcsportal.com">gspn3.samsungcsportal.com</a>
China	<a href="http://china.samsungportal.com">china.samsungportal.com</a>

This Service Manual is a property of Samsung Electronics Co., Ltd.  
Any unauthorized use of Manual can be punished under applicable  
International and/or domestic law.

© Samsung Electronics Co., Ltd. April. 2018.  
Printed in Korea.  
Code No. AC-00215E\_1