

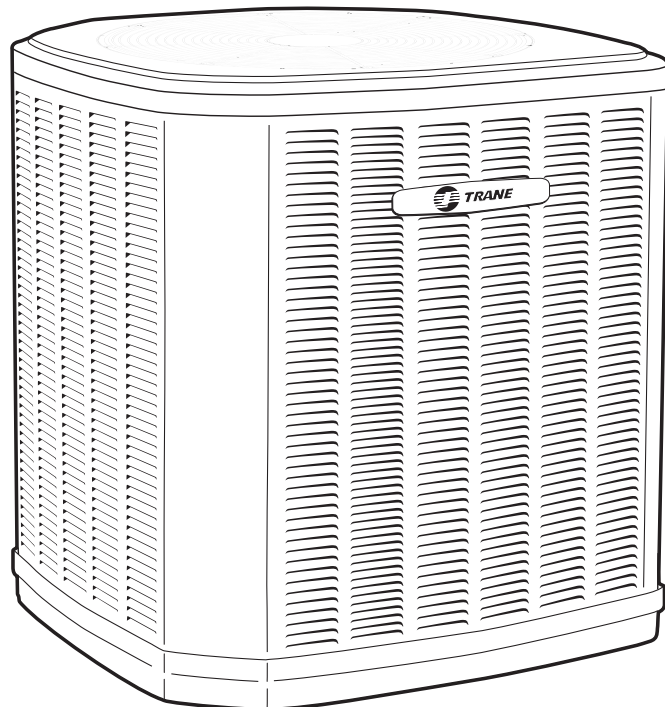

Split System Heat Pump Product Data

**XR17
4TWR7**

2, 3, 4 & 5 Tons



PUB. NO. 22-1886-6C-EN



Features and Benefits

- **CLIMATUFF™** 2-stage scroll compressor
- Efficiency up to **18.0 SEER** and **9.5 HSPF**
- All Aluminum **SPINE FIN™** coil
- **DURATUFF™** weather proof and rust proof base
- **COMFORT "R"™** mode approved for better comfort indoors
- **QUICK-SESS™** cabinet, service access and refrigerant connections with full coil protection
- **WEATHERGUARD™** fasteners
- Glossy corrosion resistant finish tarpaulin gray cabinet with anthracite gray top
- Internal compressor high/low pressure & temperature protection
- Liquid line filter/drier
- Low sound with advanced PSC fan motor
- Service valve cover
- R-410A refrigerant
- From 70 to 100% capacity modulation
- 100% run test in the factory
- Low ambient cooling to 55° as shipped
- **Extended warranties available**

Contents

Features and Benefits	2
General Data	4
Product Specifications	4
A-weighted Sound Power Level [dB(A)]	4
Accessory Description and Usage	5
AHRI Standard Capacity Rating Conditions	5
Model Nomenclature	6
Electrical Data	7
Dimensions	10
Mechanical Specifications	11



General Data

Product Specifications

Model No. ①	4TWR7024B1000AA	4TWR7036B1000D	4TWR7048A1000D	4TWR7060A1000D
Electrical Data V/Ph/Hz ②	208/230/1/60	208/230/1/60	208/230/1/60	208/230/1/60
Min Cir Ampacity	15	21	28	37
Max Fuse Size (Amps)	25	35	45	60
Compressor	CLIMATUFF® - SCROLL	CLIMATUFF® - SCROLL	CLIMATUFF® - SCROLL	CLIMATUFF® - SCROLL
No. Compress. – No. Stages	1 -2	1-2	1-2	1-2
RL AMPS - LR AMPS	11.7 - 58.3	15.3 - 83	21.2 - 104	28.8 - 152.9
Outdoor Fan FL Amps	0.71	0.74	1.05	1.30
Fan HP	1/8	1/8	1/5	1/4
Fan Dia (inches)	27.6	27.87	27.6	27.6
Coil	Spine Fin™	Spine Fin™	Spine Fin™	Spine Fin™
Refrigerant R-410A	9/0-LB/OZ	9/4-LB/OZ	12/9-LB/OZ	12/10-LB/OZ
Line Size - (in.) O.D. Gas ③	5/8	3/4	7/8	1-1/8
Line Size - (in.) O.D. Liquid ③	3/8	3/8	3/8	3/8
Dimensions H x W x D (Crated)	46.4 x 35.1 x 38.7	46.4 X 35.1 X 38.7	51.0 x 35.1 x 38.7	51.0 x 35.1 x 38.7
Weight - Shipping	272	258	329	330
Weight - Net	236	210	292	293
Start Components	NO	NO	NO	NO
Sound Enclosure	NO	NO	NO	NO
Compressor Sump Heat	YES	YES	YES	YES
Optional Accessories: ④				
Rubber Isolator Kit	BAYISLT101	BAYISLT101	BAYISLT101	BAYISLT101
Snow Leg - 7" High	BAYLEGS007	BAYLEGS007	BAYLEGS007	BAYLEGS007
Snow Leg - 4" High	BAYLEGS004	BAYLEGS004	BAYLEGS004	BAYLEGS004
Hard Start Kit Scroll	BAYKSKT263	BAYKSKT263	BAYKSKT266	BAYKSKT266
Extreme Condition Mounting Kit	BAYECMT004	BAYECMT004	BAYECMT004	BAYECMT004
Vertical Discharge Air Kit Base 4	BAYVDTA003	BAYVDTA004	BAYVDTA004	BAYVDTA004
Auto Charge Solenoid Kit	BAYCAKT001	BAYCAKT001	BAYCAKT001	BAYCAKT001
Refrigerant Lineset ⑤	TAYREFLN9*	TAYREFLN7*	TAYREFLN3*	TAYREFLN4*

① Certified in accordance with the Air-Source Unitary Heat Pump Equipment certification program which is based on AHRI Standard 210/240.

② Calculated in accordance with N.E.C. Only use HACR circuit breakers or fuses.

③ Standard line lengths - 60'. Standard lift - 25' Suction and Liquid line.

For Greater lengths and lifts refer to refrigerant piping software Pub# 32-3312-0†. (†denotes latest revision)

④ For accessory description and usage, see page 5.

⑤ * = 15, 20, 25, 30, 40 and 50 foot lineset available.

Sound Power Level

Model	A-Weighted Sound Power Level [dB(A)]	Full Octave Sound Power [dB]							
		63 Hz	125 Hz	250 Hz	500 Hz	1000 Hz	2000 Hz	4000 Hz	8000 Hz
4TWR7024B1	72	67	67	62	63	62	57	55	50
4TWR7036B1	72	66	66	64	64	63	57	54	48
4TWR7048A1	72	68	73	65	67	63	56	53	47
4TWR7060A1	74	58	75	66	68	66	59	55	52

Note: Rated in accordance with AHRI Standard 270-2008

General Data

Accessory Description and Usage

Rubber Isolators — 5 rubber donuts to isolate condensing unit from mounting frame or pad. Use on any application where sound transmission needs to be minimized.

Extreme Conditions Mounting Kit — Bracket kits to securely mount condensing unit to a frame or pad without removing any panels. Use in areas with high winds, or on commercial rooftops, etc.

Low Ambient Cooling — For low ambient cooling below 55° see Application Guide APP-APG013-EN.

AHRI Standard Capacity Rating Conditions

AHRI STANDARD 210/240 RATING CONDITIONS —

- (A) Cooling 80°F DB, 67°F WB air entering indoor coil, 95°F DB air entering outdoor coil.
- (B) High Temperature Heating 47°F DB, 43°F WB air entering outdoor coil, 70°F DB air entering indoor coil.
- (C) Low Temperature Heating 17°F DB, 15°F WB air entering outdoor coil, 70°F DB air entering indoor coil.
- (D) Rated indoor airflow for heating is the same as for cooling.

AHRI STANDARD 270 RATING CONDITIONS — (Noise rating numbers are determined with the unit in cooling operation.) Standard Noise Rating number is at 95°F outdoor air.





Model Nomenclature

Outdoor Units

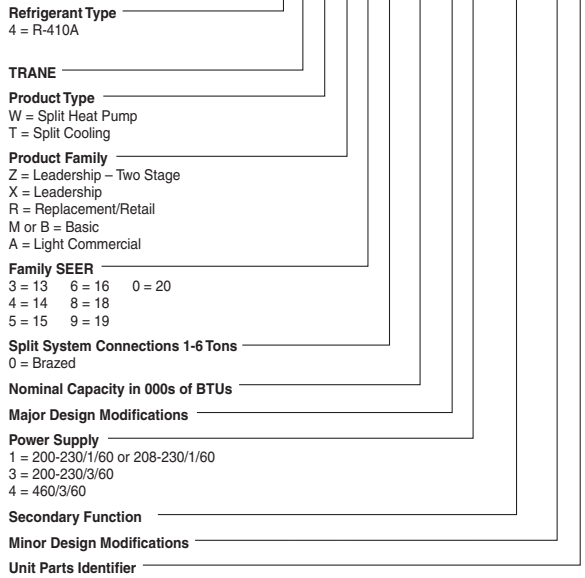

Gas Furnaces

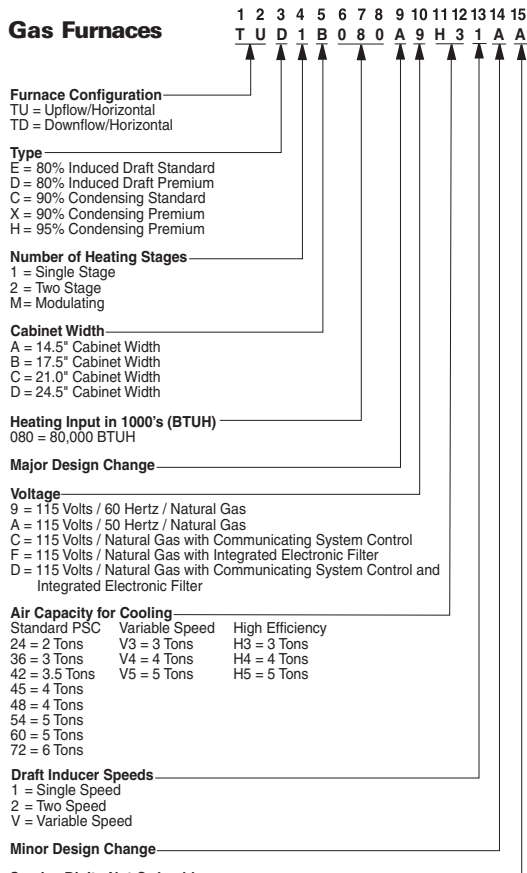

Air Handler

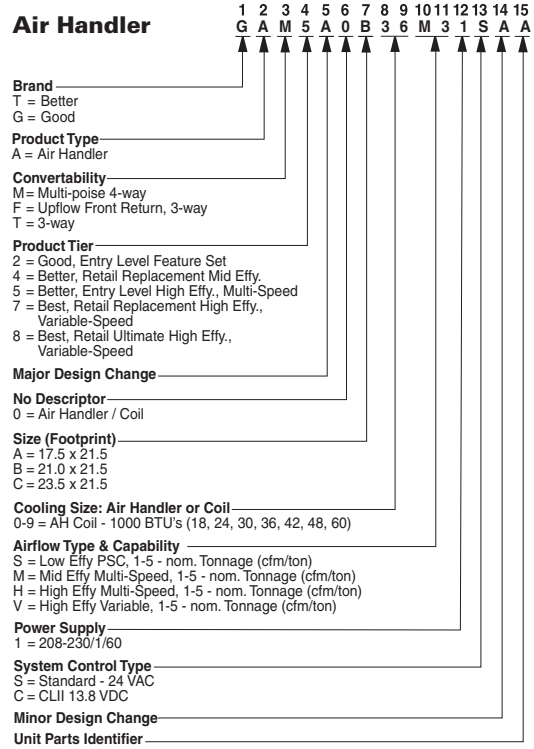

Heat Pump/ Cooling Coils

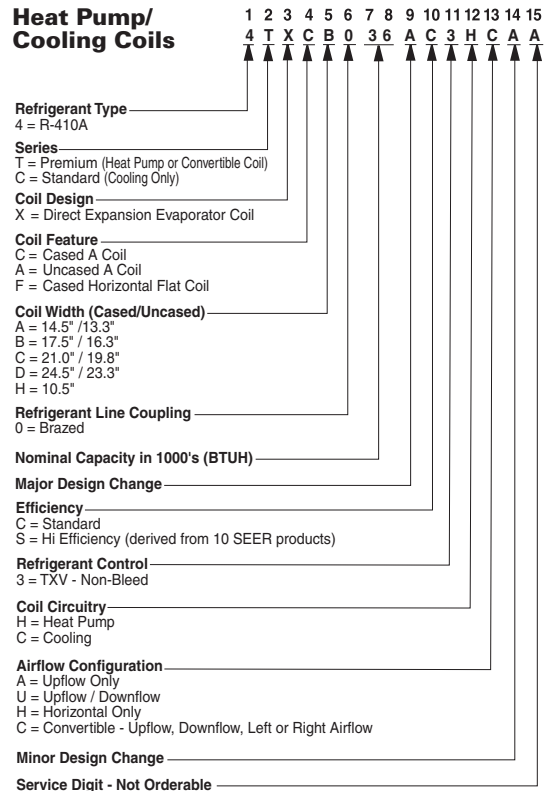

Electrical Data

Schematic Diagrams

(SEE LEGEND)

4TWR7024B, 036B

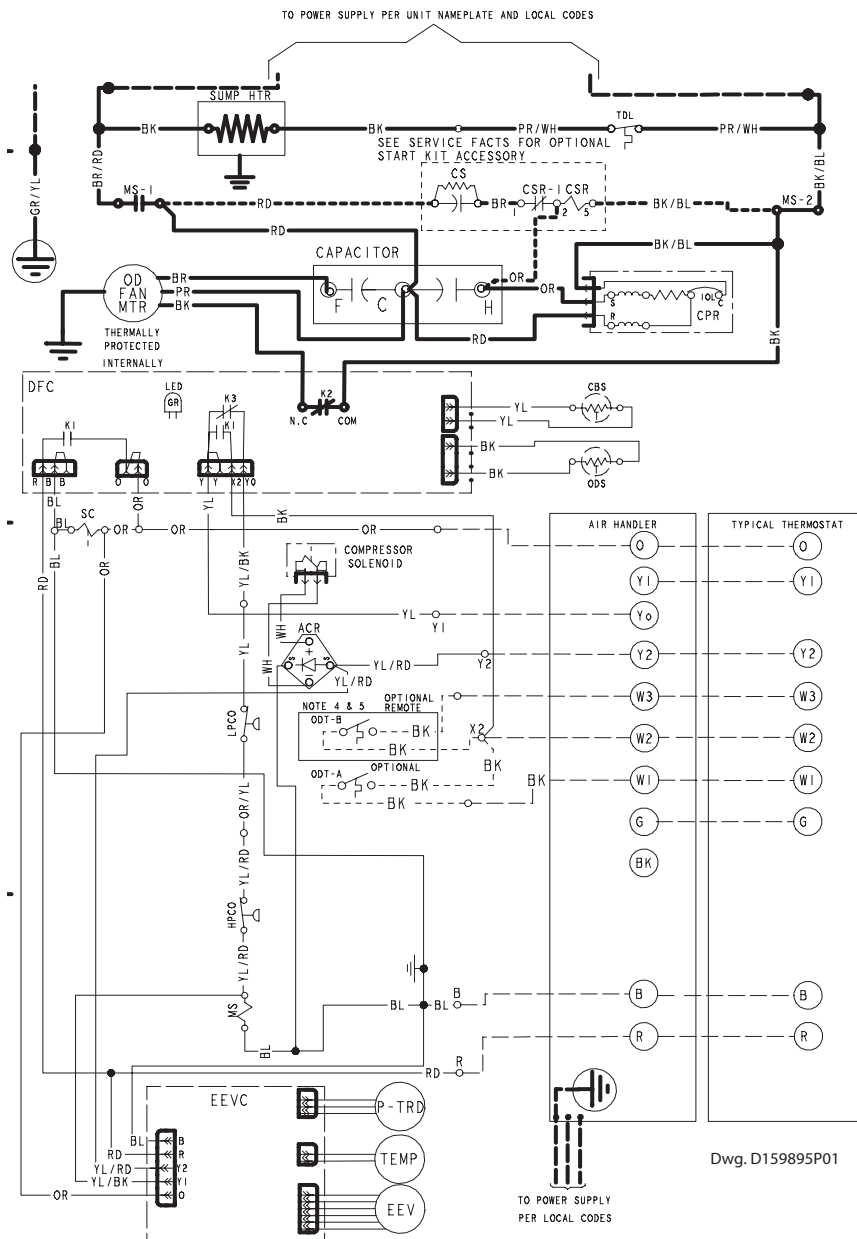

- ACR A/C RECTIFIER
- CBS COIL BOTTOM SENSOR
- CF FAN CAPACITOR
- CH WIRE CONNECTOR
- CPR COMPRESSOR
- CR RUN CAPACITOR
- CS STARTING CAPACITOR
- CSR CAPACITOR SWITCHING RELAY
- DFC DEFROST CONTROL
- EEV ELECTRONIC EXP VALVE
- EEVC ELECTRONIC EXP VALVE CONTROL
- F INDOOR FAN RELAY
- HPDC HIGH PRESSURE CUTOFF SWITCH
- IOL INTERNAL OVERLOAD PROTECTOR
- LPDC LOW PRESSURE CUTOFF SWITCH
- MS COMPRESSOR MOTOR CONTACTOR
- ODA OUTDOOR ANTICIPATOR
- ODT OUTDOOR FAN THERMOSTAT
- ODS OUTDOOR TEMPERATURE SENSOR
- ODT OUTDOOR THERMOSTAT
- P-TRD PRESSURE TRANSDUCER
- SC SWITCH OVER VALVE SOLENOID
- SW SYSTEM ON-OFF SWITCH
- TDL DISCHARGE LINE THERMOSTAT
- TDR TIME DELAY RELAY (5 SEC DELAY ON)
- TNS TRANSFORMER
- TEMP SENSOR, TEMPERATURE
- Y2C HIGH CAPACITY CONTROL RELAY

WARNING

HAZARDOUS VOLTAGE
DISCONNECT ALL ELECTRICAL POWER INCLUDING REMOTE DISCONNECTS BEFORE SERVICING.
Failure to disconnect power before servicing can cause severe personal injury or death.

CAUTION

USE COPPER CONDUCTORS ONLY!
UNIT TERMINALS ARE NOT DESIGNED TO ACCEPT OTHER TYPES OF CONDUCTORS.
Failure to do so may cause damage to the equipment.

NOTES:

1. BE SURE POWER SUPPLY AGREES WITH EQUIPMENT NAMEPLATE.
2. POWER WIRING AND GROUNDING OF EQUIPMENT MUST COMPLY WITH LOCAL CODES.
3. LOW VOLTAGE WIRING TO BE NO. 18 AWG MINIMUM CONDUCTOR.
4. ODT-B MUST BE SET LOWER THAN ODT-A
5. IF ODT-B IS NOT USED, CONNECT A JUMPER WIRE FROM W3 TO W2. IF ODT-A IS NOT USED, CONNECT A JUMPER WIRE FROM W2 TO W1.
6. IF ELECTRIC HEATER DOES NOT HAVE A 3RD CONTACTOR (CH), CONNECT A JUMPER WIRE FROM W3 TO W2. IF ELECTRIC HEATER DOES NOT HAVE A 2ND CONTACTOR (BH), CONNECT A JUMPER WIRE FROM W2 TO W1.
7. WITH Y1 ENERGIZED, INDOOR FAN IS 1ST STAGE AIRFLOW.
8. WITH Y1 & Y2 ENERGIZED, INDOOR FAN IS 2ND STAGE AIRFLOW.
9. SEE AIR HANDLER INSTALLER GUIDE FOR DIP SWITCH CONFIGURATIONS.

FOR CANADIAN INSTALLATIONS
POUR INSTALLATIONS CANADIENNES

CAUTION: NOT SUITABLE FOR USE ON SYSTEMS EXCEEDING 150V-TO-GROUND
ATTENTION: NE CONVIENT PAS AUX INSTALLATIONS DE PLUS DE 150 V A LA TERRE

Dwg. D159895P01



Electrical Data

Schematic Diagrams

(SEE LEGEND)

4TWR7048A, 060A

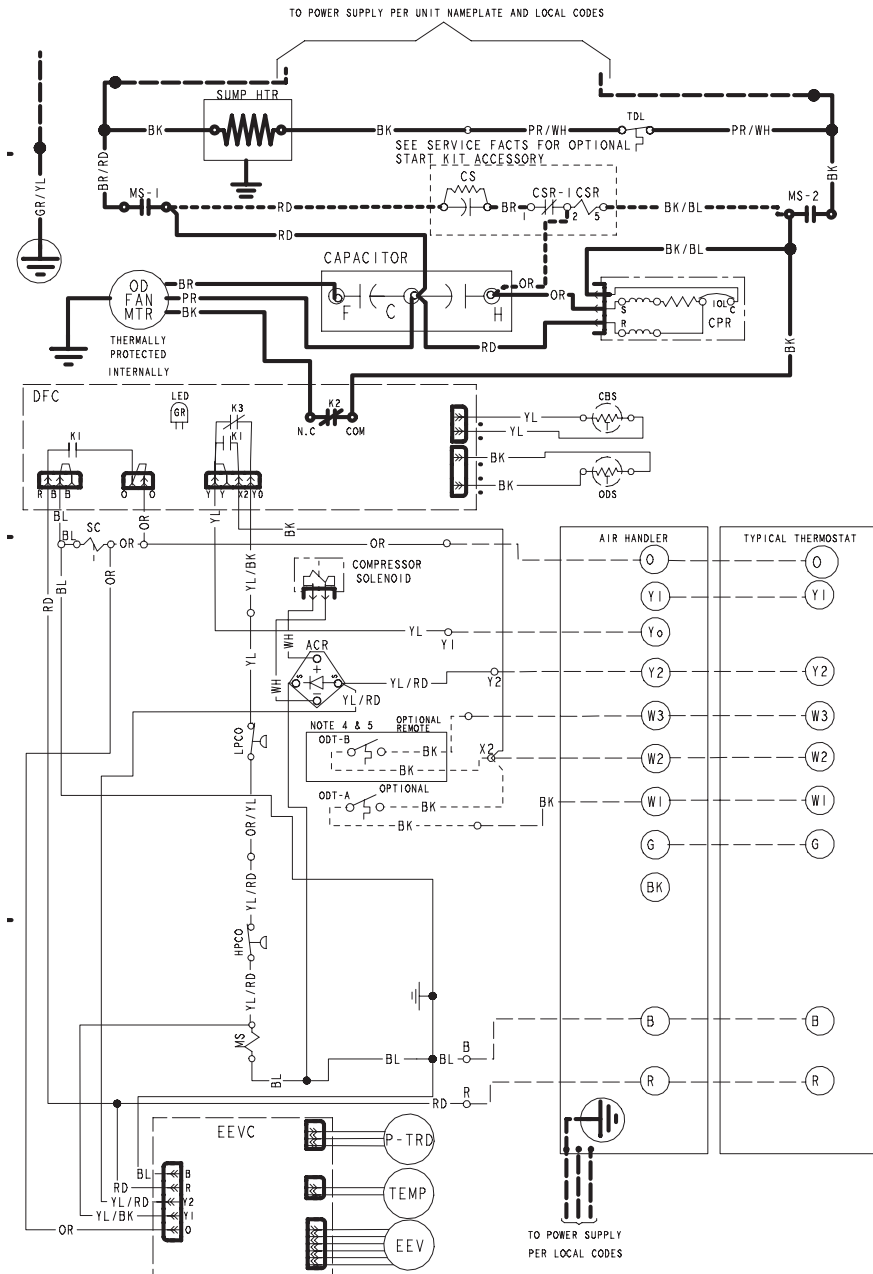

- ACR A/C RECTIFIER
- CBS COIL BOTTOM SENSOR
- CF FAN CAPACITOR
- CN WIRE CONNECTOR
- CPR COMPRESSOR
- CR RUN CAPACITOR
- CS STARTING CAPACITOR
- CSR CAPACITOR SWITCHING RELAY
- DFC DEFROST CONTROL
- EEV ELECTRONIC EXP VALVE
- EEVC ELECTRONIC EXP VALVE CONTROL
- F INDOOR FAN RELAY
- HPCO HIGH PRESSURE CUTOFF SWITCH
- IOL INTERNAL OVERLOAD PROTECTOR
- LPCCO LOW PRESSURE CUTOFF SWITCH
- MS COMPRESSOR MOTOR CONTACTOR
- ODA OUTDOOR ANTICIPATOR
- OFT OUTDOOR FAN THERMOSTAT
- ODS OUTDOOR TEMPERATURE SENSOR
- ODT OUTDOOR THERMOSTAT
- P-TRD PRESSURE TRANSDUCER
- SC SWITCH OVER VALVE SOLENOID
- SM SYSTEM ON-OFF SWITCH
- TDL DISCHARGE LINE THERMOSTAT
- TNS TRANSFORMER

WARNING

HAZARDOUS VOLTAGE!
DISCONNECT ALL ELECTRICAL POWER INCLUDING REMOTE DISCONNECTS BEFORE SERVICING.
Failure to disconnect power before servicing can cause severe personal injury or death.

CAUTION

USE COPPER CONDUCTORS ONLY!
UNIT TERMINALS ARE NOT DESIGNED TO ACCEPT OTHER TYPES OF CONDUCTORS.
Failure to do so may cause damage to the equipment.

NOTES:

1. BE SURE POWER SUPPLY AGREES WITH EQUIPMENT NAMEPLATE.
2. POWER WIRING AND GROUNDING OF EQUIPMENT MUST COMPLY WITH LOCAL CODES.
3. LOW VOLTAGE WIRING TO BE NO. 18 AWG MINIMUM CONDUCTOR.
4. ODT-B MUST BE SET LOWER THAN ODT-A
5. IF ODT-B IS NOT USED, CONNECT A JUMPER WIRE FROM W3 TO W2. IF ODT-A IS NOT USED, CONNECT A JUMPER WIRE FROM W2 TO W1.
6. IF ELECTRIC HEATER DOES NOT HAVE A 3RD CONTACTOR (CH), CONNECT A JUMPER WIRE FROM W3 TO W2. IF ELECTRIC HEATER DOES NOT HAVE A 2ND CONTACTOR (BH), CONNECT A JUMPER WIRE FROM W2 TO W1.
7. WITH Y1 ENERGIZED, INDOOR FAN IS 1ST STAGE AIRFLOW.
8. WITH Y1 & Y2 ENERGIZED, INDOOR FAN IS 2ND STAGE AIRFLOW.
9. SEE AIR HANDLER INSTALLER GUIDE FOR DIP SWITCH CONFIGURATIONS.

FOR CANADIAN INSTALLATIONS
POUR INSTALLATIONS CANADIENNES



CAUTION: NOT SUITABLE FOR USE ON SYSTEMS EXCEEDING 150V-TO-GROUND
ATTENTION: NE CONVIENT PAS AUX INSTALLATIONS DE PLUS DE 150 V A





















Drw. D159896P01

Electrical Data

Schematic Diagrams

LEGEND

 COLOR OF WIRE
 BK/BL BLACK WIRE WITH BLUE MARKER
 COLOR OF MARKER
 BK BLACK OR ORANGE YL YELLOW
 BL BLUE RD RED GR GREEN
 BR BROWN WH WHITE PR PURPLE

 24 V. } FACTORY WIRING
 LINE V. }
 24 V. } FIELD WIRING
 LINE V. }
 FIELD INSTALLED FACTORY WIRING
 GROUND
 JUNCTION
 WIRE NUT OR CONNECTOR
 COIL
 CAPACITOR
 RELAY CONTACT (N.O.)
 RELAY CONTACT (N.C.)
 THERMISTOR
 INTERNAL OVERLOAD PROTECTOR
 PRESSURE ACTUATED SWITCH
 TEMP. ACTUATED SWITCH
 POL. PLUG FEMALE HOUSING (MALE TERM.)
 POL. PLUG MALE HOUSING (FEMALE TERM.)
 RESISTOR OR HEATING ELEMENT
 MOTOR WINDING
 TERMINAL

CA	COOLING ANTICIPATOR	LPCO	LOW PRESSURE CUTOUT SW.
CBS	COIL BOTTOM SENSOR	MS	COMPRESSOR MOTOR CONTACTOR
CF	FAN CAPACITOR	ODA	OUTDOOR ANTICIPATOR
CN	WIRE CONNECTOR	OFT	OUTDOOR FAN THERMOSTAT
CPR	COMPRESSOR	ODS	OUTDOOR TEMPERATURE SENSOR
CR	RUN CAPACITOR	ODT	OUTDOOR THERMOSTAT
CS	STARTING CAPACITOR	RHS	RESISTANCE HEAT SWITCH
CSR	CAPACITOR SWITCHING RELAY	SC	SWITCHOVER VALVE SOLENOID
DFC	DEFROST CONTROL	SM	SYSTEM "ON-OFF" SWITCH
F	INDOOR FAN RELAY	TDL	DISCHARGE LINE THERMOSTAT
HA	HEATING ANTICIPATOR	TNS	TRANSFORMER
HPCO	HIGH PRESSURE CUTOUT SW.	TS	HEATING-COOLING THERMOSTAT
IOL	INTERNAL OVERLOAD PROTECTOR	TSH	HEATING THERMOSTAT



Dimensions

4TWR7 Outline Drawing

Note: All dimensions are in MM (Inches).

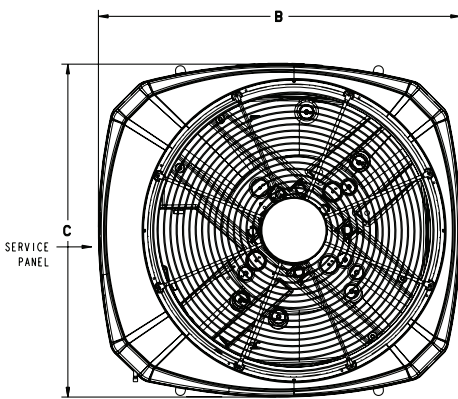

TOP DISCHARGE AREA SHOULD BE UNRESTRICTED FOR AT LEAST 1524 (5 FEET) ABOVE UNIT. UNIT SHOULD BE PLACED SO ROOF RUN-OFF WATER DOES NOT POUR DIRECTLY ON UNIT, AND SHOULD BE AT LEAST 305 (12") FROM WALL AND ALL SURROUNDING SHRUBBERY ON TWO SIDES. OTHER TWO SIDES UNRESTRICTED.

ELECTRICAL AND REFRIGERANT COMPONENT CLEARANCES PER PREVAILING CODES.

FIG. 1

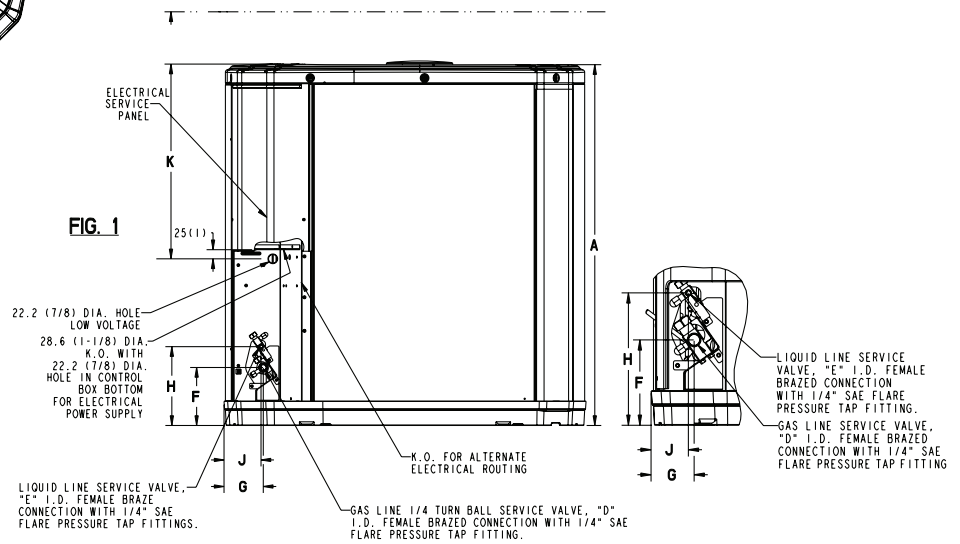

MODELS	BASE	A	B	C	D	E	F	G	H	J	K
4TWR7024B	4	1045 (41 1/8)	946 (37-1/4)	870 (34-1/4)	5/8	3/8	152 (6)	98 (3-7/8)	219 (8-5/8)	86 (3-3/8)	711 (28)
4TWR7036B	4	1045 (41 1/8)	946 (37-1/4)	870 (34-1/4)	3/4	3/8	152 (6)	98 (3-7/8)	219 (8-5/8)	86 (3-3/8)	711 (28)
4TWR7048A	4	1147 (45 1/8)	946 (37-1/4)	870 (34-1/4)	7/8	3/8	152 (6)	98 (3-7/8)	219 (8-5/8)	86 (3-3/8)	813 (32)
4TWR7060A	4	1147 (45 1/8)	946 (37-1/4)	870 (34-1/4)	1-1/8	3/8	152 (6)	98 (3-7/8)	219 (8-5/8)	86 (3-3/8)	813 (32)

Mechanical Specifications

General

The 4TWR7 is fully charged from the factory for matched indoor section and up to 15 feet of piping. This unit is designed to operate at outdoor ambient temperatures as high as 115°F. Cooling capacities are matched with a wide selection of air handlers and furnace coils that are AHRI certified. The unit shall be certified to UL 1995. Exterior is designed for outdoor application.

Casing

Unit casing is constructed of heavy gauge, G60 galvanized steel and painted with a weather-resistant powder paint on all louvers and panels. Corrosion and weatherproof CMBP-G30 DuraTuff™ base.

Refrigerant Controls

Refrigeration system controls include condenser fan, compressor contactor and high pressure switch. High and low pressure controls are inherent to the compressor. A factory installed liquid line drier is standard.

Compressor

The Climatuff® 2-stage compressor features internal over temperature and pressure protection and hermetic motor. Other features include: centrifugal oil pump and modular plugs for electrical connections.

Condenser Coil

The outdoor coil provides low airflow resistance and efficient heat transfer. The coil is protected on all four sides by louvered panels.

Low Ambient Cooling

As manufactured, this unit has a cooling capability to 55°F. For low ambient cooling below 55° see Application Guide.

